

DA112	DA115	DA119	DAN202C	DAP202K	DAN2
DA113	DA116	DA120	DAP202C	DAN202U	DAN2
DA114	DA118	DA121	DAN202K	DAP202U	DAN2
					DAP22

Diode, array, high-speed switching, surface mount

Dimensions (Units : mm)

In these single packages, there are one or two diodes as shown in the circuit diagrams.

Features

available in the following 3-pin packages:

- SSD3 (SST, US/European SOT-23) (similar to SC-59)
- SMD3 (SMO, SC-59, Japanese SOT-23)
- UMD3 (UMD, SC-90, SOT-323)
- EMD3 (EMO, 50-90)
- products are marked as follows:

DA112=AZ	DAN202C=N
DA113=AY	DAP202C=P
DA114=AV	DAN202K=N
DA115 = AU	DAP202K =P
DA116=AZ	DAN202U=N
DA118=AY	DAP202U=P
DA119=AU	DAN212C=N
DA120 = AZ	DAN212K =AV
DA121=AV	DAN222=N
	DAP222 = P

- suitable for automatic mounting on printed circuit board
- high switching speed ($t_{rr} = 1.5$ ns typically)
- all diodes in the chip have similar characteristics

Applications

- ultra high speed switching

DA116, DA118, DA119, DAN202K, DAP202K, DAN212K (SMD3)

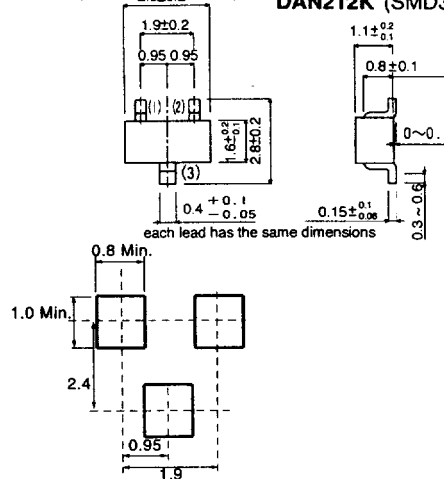

DA112, DA113, DA114, DA115, DAN202U, DAP202U (UMD3)

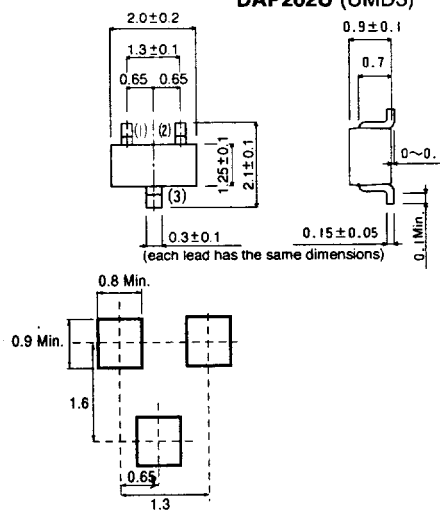

DAI12 - DAI16, DAI18 - DAI21, DAN(P)202C(K)(U), DAN212C(K), DAN(P)222 Diode arrays

DA120, 0A121,
DAN222, DAP222 (EMD3)

DAN202C, DAP202C,
DAN212C (SSD3)

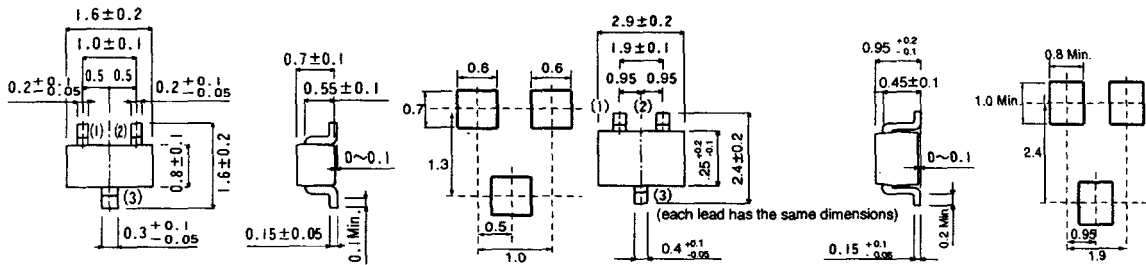

Equivalent circuits

et4U.com

DataSheet4U.com

DataShee

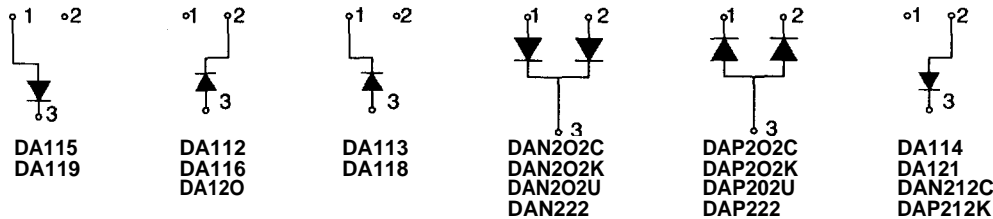

Absolute maximum ratings (Ta = 25°C) (Sheet 1 of 2)

Part no.	Peak reverse voltage V _{RM} (V)	DC reverse voltage V _R (V)	Peak forward current I _F (mA)	Mean rectifying current I _O (mA)	Surge current (1μs) I _{surge} (A)	Power dissipation (Total) P _d (mW)	Junction temp. T _J (°C)	Storage temp. T _{stg} (°C)	Type
DA112	80	80	300	100	4	200	150	-55 ~ +150	P
DA113	80	80	300	100	0.5	200	150	-55 ~ +150	P
DA114	80	80	300	100	4	200	150	-55 ~ +150	N
DA115	80	80	300	100	4	200	150	-55 ~ +150	N
DA116	80	80	300	100	4	200	150	-55 ~ +150	P
DA118	80	80	300	100	4	200	150	-55 ~ +150	P
DA119	80	80	300	100	4	200	150	-55 ~ +150	N
DA120	80	80	300	100	4	150	150	-55 ~ +150	P
DA121	80	80	300	100	4	150	150	-55 ~ +150	N
DAN202C	80	80	300	100	4	150	150	-55 ~ +150	N
DAN202K	80	80	300	100	4	150	150	-55 ~ +150	N
DAP202C	80	80	300	100	4	150	150	-55 ~ +150	P
DAP202K	80	80	300	100	4	150	150	-55 ~ +150	P

DataSheet4U.com

www.DataSheet4U.com

Diode arrays DA112 - DA116, DA118 - DA121, DAN(P)202C(K)(U), DAN212C(K), DAN(P)222

Absolute maximum ratings (Ta = 25°C) (Sheet 2 of 2)

Part no.	Peak reverse voltage V _{RM} (V)	DC reverse voltage V _R (V)	Peak forward current I _F (mA)	Mean rectifying current I _O (mA)	Surge current (1μs) I _{surge} (A)	Power dissipation (Total) P _d (mW)	Junction temp. T _j (°C)	Storage temp. T _{stg} (°C)	Type
DAN202U	80	80	300	100	4	150	150	-55 ~ +150	N
DAP202U	80	80	300	100	4	150	150	-55 ~ +150	P
DAN212C	80	80	300	100	4	150	150	-55 ~ +150	N
DAN212K	80	80	300	100	4	150	150	-55 ~ +150	N
DAN222	80	80	300	100	4	150	150	-55 ~ +150	N
DAP222	80	80	300	100	4	150	150	-55 ~ +150	P

Electrical characteristics (unless otherwise noted, Ta = 25°C)

Part no.	Forward voltage		Reverse current		Capacitance between terminals			Reverse recovery time			
	V _F (V) Max	I _F (mA)	I _R (μA) Max	V _R (V)	C _T (pF) max.	V _R (V)	f (MHz)	t _{rr} (nS) Max	V _R (V)	I _F (mA)	Ref
DA112	1.2	100	0.1	70	3.5	6	1	4	6	5	Figure 8
DA113	1.2	100	0.1	70	3.5	6	1	4	6	5	Figure 8
DA114	1.2	100	0.1	70	3.5	6	1	4	6	5	Figure 8
DA115	1.2	100	0.1	70	3.5	6	1	4	6	5	Figure 8
DA116	1.2	100	0.1	70	3.5	6	1	4	6	5	Figure 8
DA118	1.2	100	0.1	70	3.5	6	1	4	6	5	Figure 8
DA119	1.2	100	0.1	70	3.5	6	1	4	6	5	Figure 8
DA120	1.2	100	0.1	70	3.5	6	1	4	6	5	Figure 8
DA121	1.2	100	0.1	70	3.5	6	1	4	6	5	Figure 8
DAN202C	1.2	100	0.1	70	3.5	6	1	4	6	5	Figure 8
DAN202K	1.2	100	0.1	70	3.5	6	1	4	6	5	Figure 8
DAP202C	1.2	100	0.1	70	3.5	6	1	4	6	5	Figure 8
DAP202K	1.2	100	0.1	70	3.5	6	1	4	6	5	Figure 8
DAN202U	1.2	100	0.1	70	3.5	6	1	4	6	5	Figure 8
DAP202U	1.2	100	0.1	70	3.5	6	1	4	6	5	Figure 8
DAN212C	1.2	100	0.1	70	3.5	6	1	4	6	5	Figure 8
DAN212K	1.2	100	0.1	70	3.5	6	1	4	6	5	Figure 8
DAN222	1.2	100	0.1	70	3.5	6	1	4	6	5	Figure 8
DAP222	1.2	100	0.1	70	3.5	6	1	4	6	5	Figure 8

DAI12- DAI16, DAI18 - DAI21, DAN(P)202C(K)(U), DAN212C(K), DAN(P)222 Diode arrays

Electrical characteristic curves

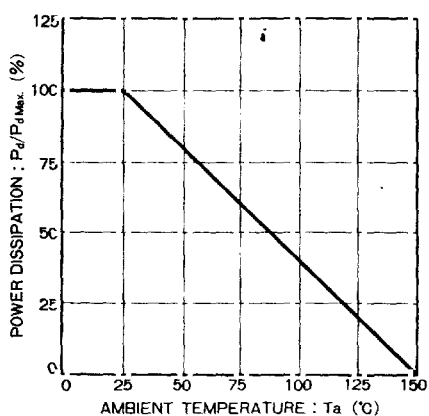

Figure 1

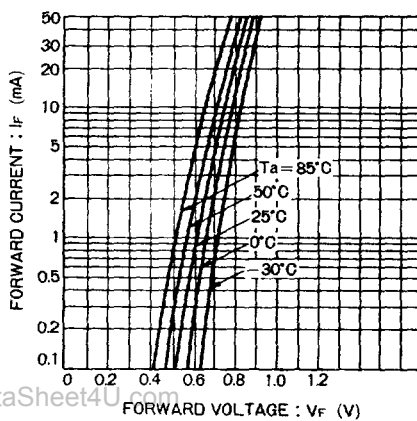

Figure 2

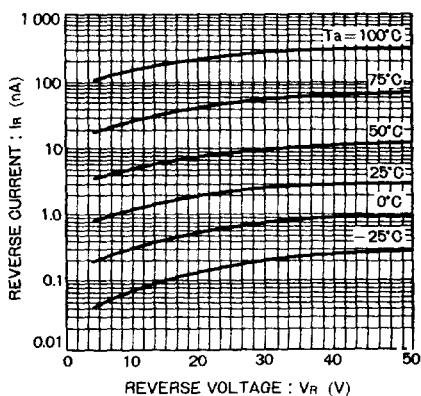

Figure 3

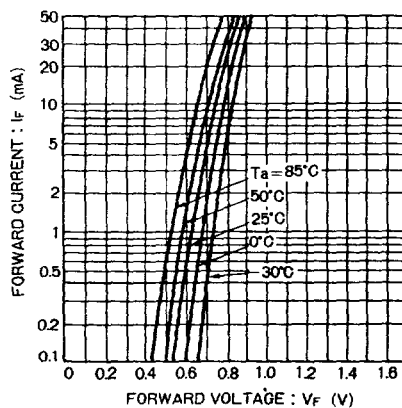

Figure 4

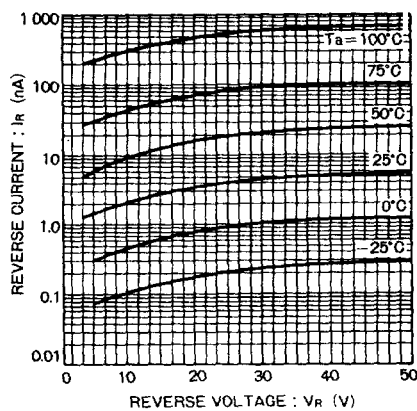

Figure 5

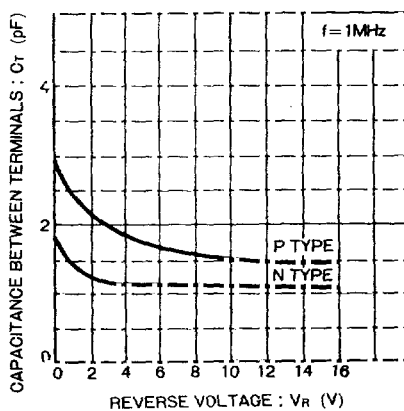

Figure 6

et4U.com

DataSheet4U.com

DataShee

Diode arrays DAI12, DAI16, DAI18, DAI21, DAN(P)202C(K)(U), DAN212C(K), DAN(P)222

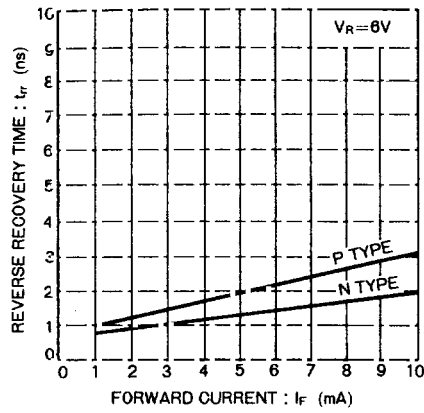

Figure 7

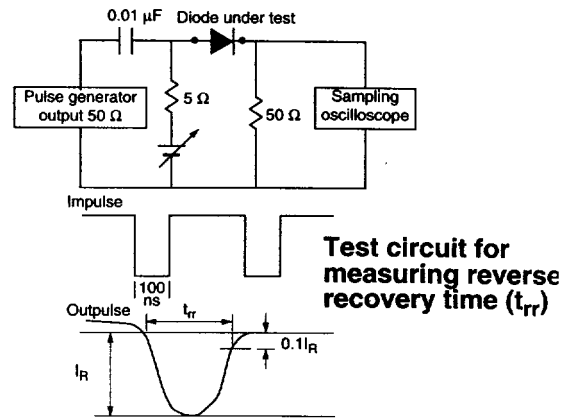

Figure 8