

Powerex, Inc., Hillis Street, Youngwood, Pennsylvania 15697 (412) 925-7272  
 Powerex, Europe, S.A. 428 Avenue G. Durand, BP107, 72003 Le Mans, France (43) 41.14.14

**Intellimod™-3 Modules**  
 Single Phase  
 IGBT Inverter Output  
 150 Amperes/110-230 Volt Line

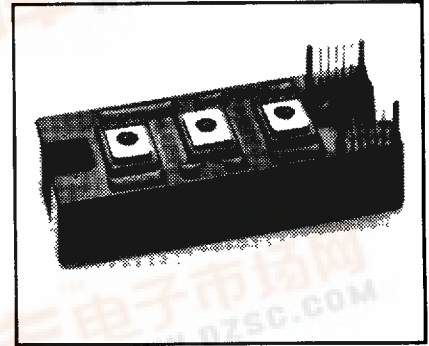
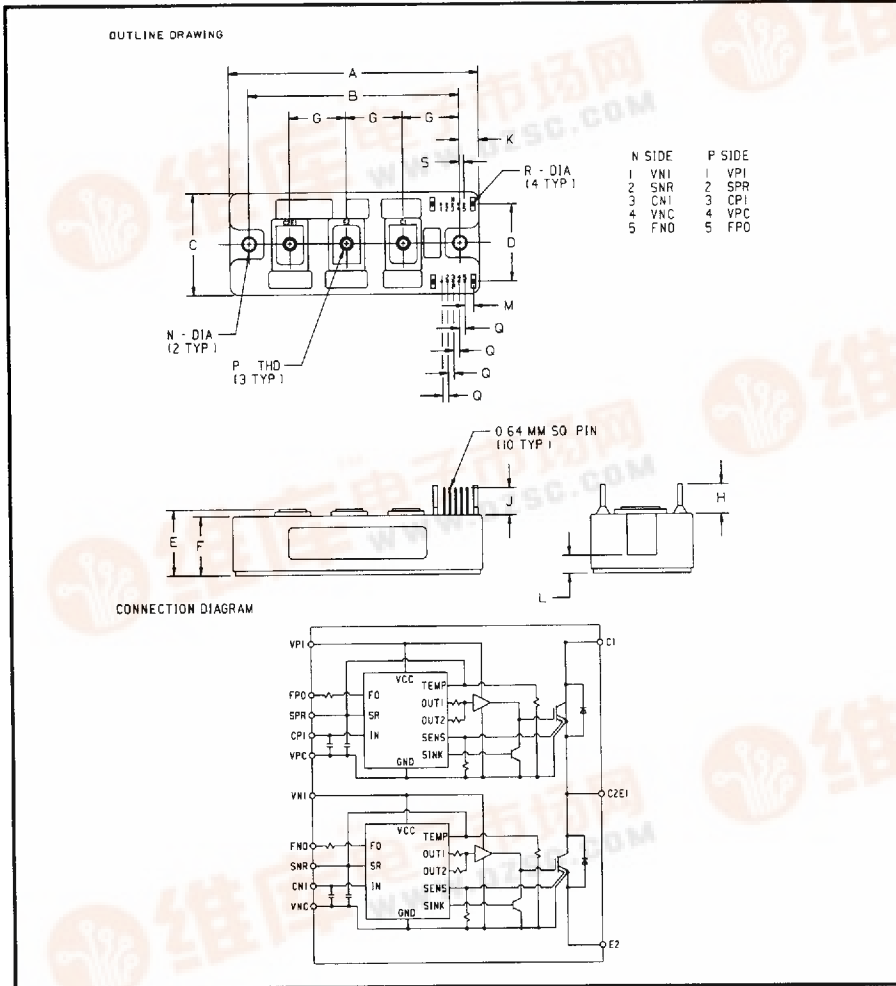

**Description**

Powerex Intellimod-3 Modules are designed for applications requiring a high frequency (20kHz) output switching inverter. The modules are isolated from the baseplate, consisting of complete drive, control and protection circuitry for the IGBT inverter.

**Features:**

- Complete Output Power Circuit
- Gate Drive Circuit
- Protection Logic
  - Short Circuit
  - Over-Current
  - Over Temperature
  - Under Voltage

**Applications:**

- Inverters
- Small UPS
- Motion/Servo Control
- AC Motor Control

**Ordering Information**  
 PM150DHA060

110-230 Volt Line, PM150DHA060 Outline Drawing

Dimensions	Inches	Millimeters
A	4.33	110.0
B	3.66±0.01	93.0±0.25
C	1.77	45.0
D	1.34	34.0
E	1.14+0.04/-0.02	29.0+1.0/-0.5
F	1.02	26.0
G	0.98	25.0
H	0.51	13.0
J	0.47	12.0

Dimensions	Inches	Millimeters
K	0.33	8.5
L	0.31	8.0
M	0.23	5.84
N	0.22 Dia.	5.5 Dia.
P	Metric M5	M5
Q	0.1	2.54
R	0.8 Dia.	2.0 Dia.
S	0.08	2.0



POWEREX INC

SIE D ■ 7294621 0005715 656 ■ PRX ■

Powerex, Inc., Hillis Street, Youngwood, Pennsylvania 15697 (412) 925-7272

Powerex, Europe, S.A. 428 Avenue G. Durand, BP107, 72003 Le Mans, France (43) 41.14.14

PM150DHA060

Intellimod-3 Modules

Single Phase IGBT Inverter Output

150 Amperes/110-230 Volt Line

T-57-29

**Absolute Maximum Ratings,  $T_j = 25\text{ }^\circ\text{C}$  unless otherwise specified**

Characteristics	Symbol	PM150DHA060	Units
Power Device Junction Temperature	$T_j$	-20 to +150	$^\circ\text{C}$
Storage Temperature	$T_{STG}$	-40 to +125	$^\circ\text{C}$
Case Operating Temperature	$T_C$	-20 to +100	$^\circ\text{C}$
Mounting Torque, M5 Mounting Screws	—	17	Kg-cm
Mounting Torque, M5 Main Terminal Screws	—	17	Kg-cm
Module Weight (Typical)	—	340	Grams
Supply Voltage Protected by OC and SC ( $V_D = 13.5 - 16.5\text{V}$ , Inverter Part)	$V_{CC(prot.)}$	400	Volts
Isolation Voltage AC 1 minute, 60Hz	$V_{RMS}$	2500	Volts

**Control Sector**

Supply Voltage Applied between ( $V_{P1} - V_{PC}, V_{N1} - V_{NC}$ )	$V_D$	20	Volts
Input Voltage Applied between ( $C_{P1} - V_{PC}, C_{N1} - V_{NC}$ )	$V_{CIN}$	10	Volts
Fault Output Supply Voltage Applied between ( $F_{PO} - V_{PC}, F_{NO} - V_{NC}$ )	$V_{FO}$	20	Volts
Fault Output Current (Sink Current at $F_{PO}, F_{NO}$ Terminals)	$I_{FO}$	20	mA

**IGBT Inverter Sector**

Collector-Emitter Voltage	$V_{CES}$	600	Volts
Collector Current $\pm$	$I_C$	150	Amperes
Peak Collector Current $\pm$	$I_{CP}$	300	Amperes
Supply Voltage (Applied C1 to E2)	$V_{CC}$	450	Volts
Supply Voltage (Surge) Applied C1 to E2	$V_{CC(surge)}$	500	Volts
Collector Dissipation	$P_C$	595	Watts





POWEREX INC

51E D ■ 7294621 0005716 592 ■ PRX

Powerex, Inc., Hillis Street, Youngwood, Pennsylvania 15697 (412) 925-7272  
 Powerex, Europe, S.A. 428 Avenue G. Durand, BP107, 72003 Le Mans, France (43) 41.14.14

**PM150DHA060**  
**Intellimod-3 Modules**  
**Single Phase IGBT Inverter Output**  
 150 Amperes/110-230 Volt Line

T-57-29

**Electrical Characteristics,  $T_j = 25^\circ\text{C}$  unless otherwise specified**

Characteristics	Symbol	Test Conditions	Min.	Typ.	Max.	Units
<b>Control Sector</b>						
Overcurrent Trip Level	OC	$-20^\circ\text{C} \leq T \leq 125^\circ\text{C}$ , Fig. 5	210	300	–	Amperes
Short Circuit Trip Level	SC	$-20^\circ\text{C} \leq T \leq 125^\circ\text{C}$ , Fig. 5	300	420	–	Amperes
Over Current Delay Time	$t_{off(OC)}$	$V_D = 15\text{V}$ , Fig. 5	–	5	–	$\mu\text{S}$
Over Temperature Protection	OT	Trip Level	100	110	120	$^\circ\text{C}$
Over Temperature Protection	$OT_R$	Reset Level	85	95	105	$^\circ\text{C}$
Supply Circuit Under Voltage Protection	UV	Trip Level	11.5	12.0	12.5	Volts
Supply Circuit Under Voltage Protection	$UV_R$	Reset Level	–	12.5	–	Volts
Supply Voltage	$V_D$	Applied between $V_{P1} - V_{PC}, V_{N1} - V_{NC}$	13.5	15	16.5	Volts
Circuit Current	$I_D$	$V_D = 15\text{V}, V_{CIN} = 5\text{V}, V_{N1} - V_{NC}$	–	13	20	mA
	$I_D$	$V_D = 15\text{V}, V_{CIN} = 5\text{V}, V_{P1} - V_{PC}$	–	13	20	mA
Input On Voltage	$V_{CIN(on)}$	Applied between $C_{P1} - V_{PC}, C_{N1} - V_{NC}$	1.2	1.5	1.8	Volts
Input Off Voltage	$V_{CIN(off)}$		1.7	2.0	2.3	Volts
PWM Input Frequency	$f_{PWM}$	3- $\emptyset$ Sinusoidal	–	15	20	kHz
Dead Time	$t_{DEAD}$	For each Input Pulse	4.0	–	–	$\mu\text{S}$
		Using example Interface Circuit*	6.0	–	–	$\mu\text{S}$
Fault Output Current	$I_{FO(H)}$	$V_D = 15\text{V}, V_{FO} = 15\text{V}$	–	–	0.01	mA
	$I_{FO(L)}$	$V_D = 15\text{V}, V_{FO} = 15\text{V}$	–	10	15	mA
Minimum Fault Output Pulse Width	$t_{FO}$	$V_D = 15\text{V}$	1.0	1.8	–	mS
SXR Terminal Output Voltage	$V_{SXR}$	$T_j = 125^\circ\text{C}, R_{IN} = 6.8\text{k}\Omega, (S_{PR}, S_{NR})$	4.5	5.1	5.6	Volts

\*See Intellimod-3 Applications Data Section 4.3.





POWEREX INC

51E D ■ 7294621 0005717 429 ■ PRX

Powerex, Inc., Hillis Street, Youngwood, Pennsylvania 15697 (412) 925-7272

Powerex, Europe, S.A. 428 Avenue G. Durand, BP107, 72003 Le Mans, France (43) 41.14.14

PM150DHA060

Intellimod-3 Modules

Single Phase IGBT Inverter Output

150 Amperes/110-230 Volt Line

T-57-29

### Electrical Characteristics, $T_j = 25^\circ\text{C}$ unless otherwise specified

Characteristics	Symbol	Test Conditions	Min.	Typ.	Max.	Units
<b>IGBT Inverter Sector</b>						
Collector Cutoff Current	$I_{CES}$	$V_{CE} = V_{CES}, T_j = 25^\circ\text{C}$ , Fig. 4	–	–	1	mA
Collector Cutoff Current	$I_{CES}$	$V_{CE} = V_{CES}, T_j = 125^\circ\text{C}$ , Fig. 4	–	–	10.0	mA
Diode Forward Voltage	$V_{FM}$	$-I_C = 150\text{A}, V_{CIN} = 5\text{V}$ , Fig. 2	–	1.6	2.5	Volts
Collector Emitter Saturation Voltage	$V_{CE(sat)}$	$V_D = 15\text{V}, V_{CIN} = 0\text{V}, I_C = 150\text{A}$ , Fig. 1	–	2.6	3.5	Volts
Collector Emitter Saturation Voltage	$V_{CE(sat)}$	$V_D = 15\text{V}, V_{CIN} = 0\text{V}, I_C = 150\text{A}$ , $T_j = 125^\circ\text{C}$ , Fig. 1	–	2.4	3.4	Volts
Inductive Load Switching Times	$t_{on}$	$V_D = 15\text{V}, V_{CIN} = 0\text{V}$ , $V_{CC} = 300\text{V}, I_C = 150\text{A}$ , $T_j = 125^\circ\text{C}$ Fig. 3	0.5	1.4	2.5	$\mu\text{S}$
	$t_{rr}$		–	0.2	0.4	$\mu\text{S}$
	$t_{C(on)}$		–	0.4	1.0	$\mu\text{S}$
	$t_{off}$		–	2.0	3.0	$\mu\text{S}$
	$t_{C(off)}$		–	0.5	1.0	$\mu\text{S}$

### Thermal Characteristics

Characteristics	Symbol	Test Conditions	Min.	Typ.	Max.	Units
Thermal Resistances Junction to Case	$R_{th(l-c)Q}$	Inverter IGBT	–	–	0.21	$^\circ\text{C/W}$
	$R_{th(l-c)F}$	Inverter FWD	–	–	0.47	$^\circ\text{C/W}$
Contact Thermal Resistance	$R_{th(c-f)}$	Case to Fin, Thermal Grease Applied	–	–	0.12	$^\circ\text{C/W}$

### Recommended Operating Conditions

Characteristics	Symbol	Test Conditions	Value	Units
Supply Voltage	$V_{CC}$	Applied across C1 - E2 Terminals	0 ~ 400	Volts
	$V_D$	Applied between $V_{P1} - V_{PC}, V_{N1} - V_{NC}$	$15 \pm 1.5$	Volts
Input On Voltage	$V_{CIN(on)}$	Applied between $C_{P1} - V_{PC}, C_{N1} - V_{NC}$	0 ~ 0.8	Volts
Input Off Voltage	$V_{CIN(off)}$		4 ~ $V_{SXR}$	Volts
PWM Input Frequency	$f_{PWM}$	Using example Interface Circuit *	5 ~ 20	kHz
Minimum Dead Time	$t_{DEAD}$	Using example Interface Circuit *	6.0	$\mu\text{S}$

\*See Intellimod -3 Applications Data Section 4.3.





POWEREX INC

51E D ■ 7294621 0005718 365 ■ PRX

Powerex, Inc., Hillis Street, Youngwood, Pennsylvania 15697 (412) 925-7272  
 Powerex, Europe, S.A. 428 Avenue G. Durand, BP107, 72003 Le Mans, France (43) 41.14.14

PM150DHA060  
 Intellimod-3 Modules  
 Single Phase IGBT Inverter Output  
 150 Amperes/110-230 Volt Line

T-57-29

SATURATION VOLTAGE CHARACTERISTICS (TYPICAL)

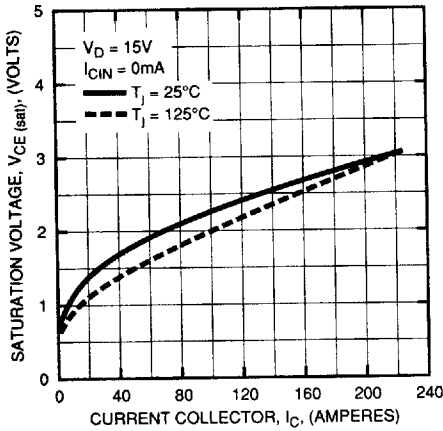

COLLECTOR-EMITTER SATURATION VOLTAGE (TYPICAL)

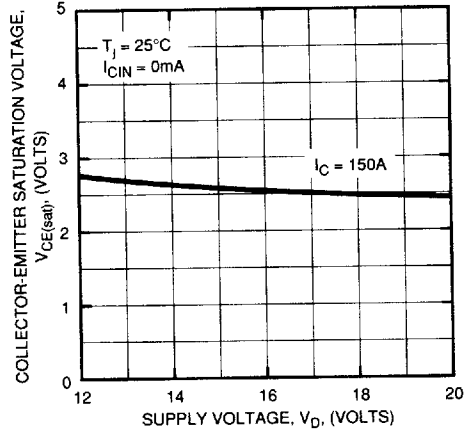

OUTPUT CHARACTERISTICS (TYPICAL)

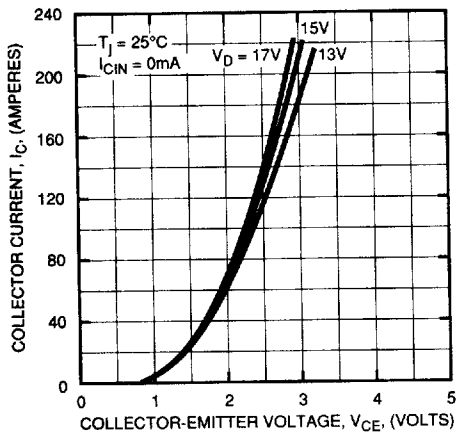

SWITCHING TIME VS. COLLECTOR CURRENT (TYPICAL)

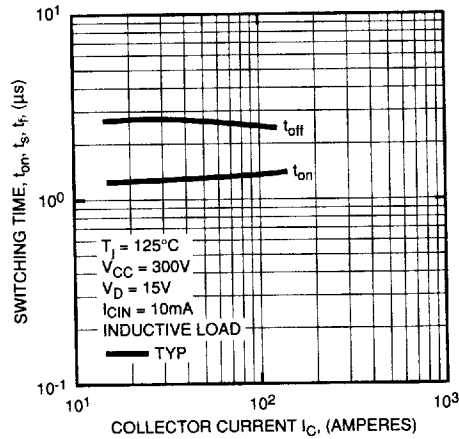

SWITCHING TIME VS. COLLECTOR CURRENT (TYPICAL)

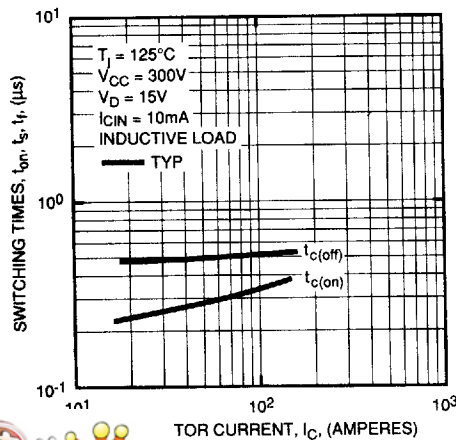

REVERSE COLLECTOR CURRENT VS. EMITTER-COLLECTOR VOLTAGE (DIODE FORWARD CHARACTERISTICS) (TYPICAL)

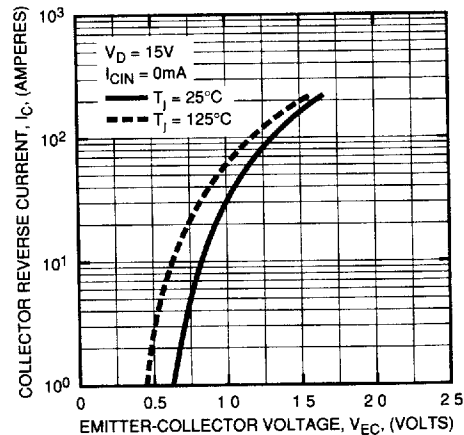



POWEREX INC

SIE D ■ 7294621 0005719 2T1 ■ PRX

Powerex, Inc., Hillis Street, Youngwood, Pennsylvania 15697 (412) 925-7272

Powerex, Europe, S.A. 428 Avenue G. Durand, BP107, 72003 Le Mans, France (43) 41.14.14

PM150DHA060

Intellimod-3 Modules

Single Phase IGBT Inverter Output

150 Amperes/110-230 Volt Line

T-57-29

POWER DISSIPATION DERATING CURVE  
(PER IGBT ELEMENT)

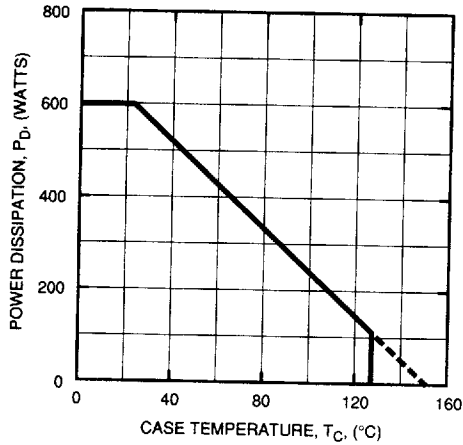

CIRCUIT CURRENT  
VS. CARRIER FREQUENCY

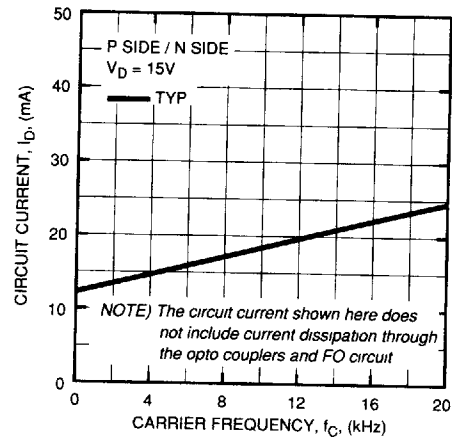

TRANSIENT THERMAL  
IMPEDANCE CHARACTERISTICS  
(IGBT)

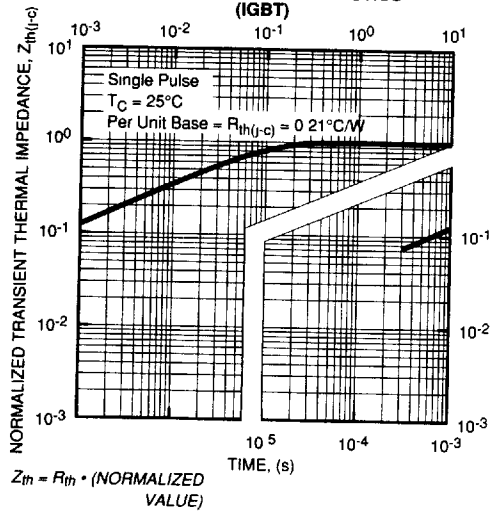

TRANSIENT THERMAL  
IMPEDANCE CHARACTERISTICS  
(FWD)

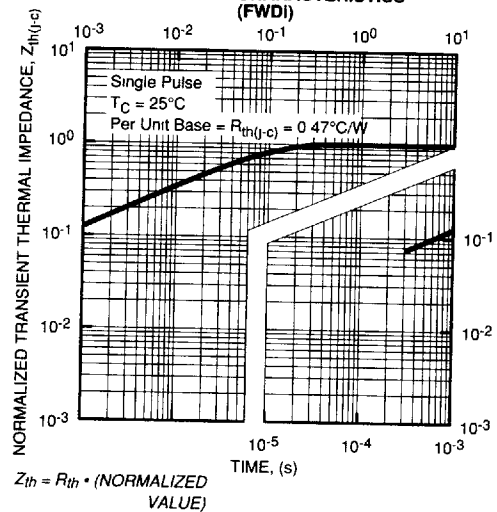



POWEREX INC

SLE D ■ 7294621 0005720 T13 ■ PRX

Powerex, Inc., Hillis Street, Youngwood, Pennsylvania 15697 (412) 925-7272  
 Powerex, Europe, S.A. 428 Avenue G. Durand, BP107, 72003 Le Mans, France (43) 41.14.14

T-57-29

PM150DHA060  
 Intellmod-3 Modules  
 Single Phase IGBT Inverter Output  
 150 Amperes/110-230 Volt Line

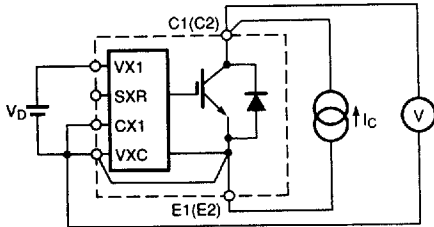

Figure 1  $V_{CE(SAT)}$  Test

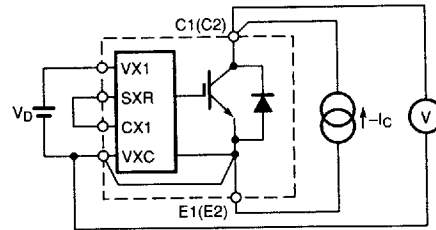

Figure 2  $V_{EC}$  Test

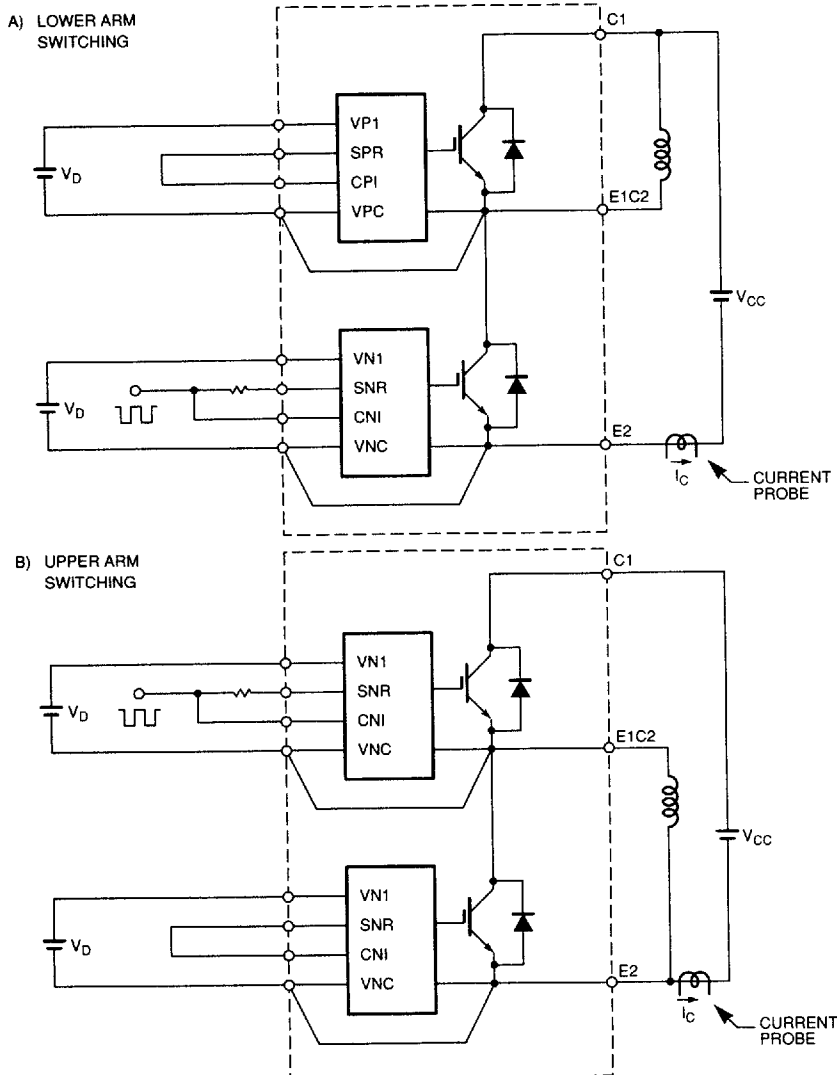

Figure 3 Half Bridge Switching Test and Waveform





POWEREX INC

51E D ■ 7294621 0005721 95T ■ PRX

Powerex, Inc., Hillis Street, Youngwood, Pennsylvania 15697 (412) 925-7272  
Powerex, Europe, S.A. 428 Avenue G. Durand, BP107, 72003 Le Mans, France (43) 41.14.14

PM150DHA060  
Intellimod-3 Modules  
Single Phase IGBT Inverter Output  
150 Amperes/110-230 Volt Line

T-57-29

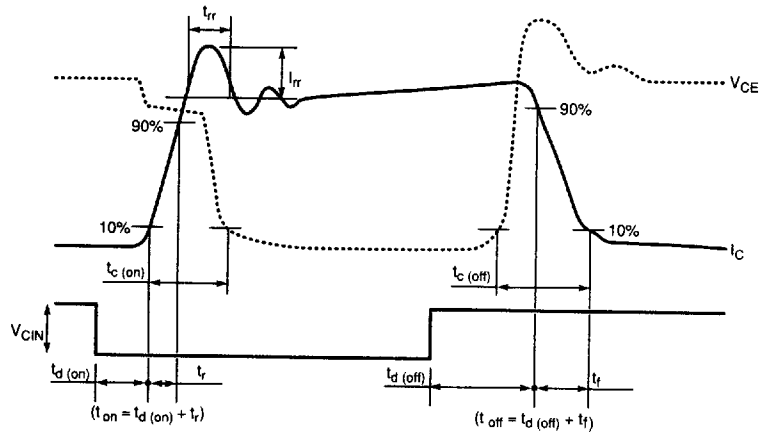

Figure 3 Half Bridge Switching Test and Waveform (Continued)

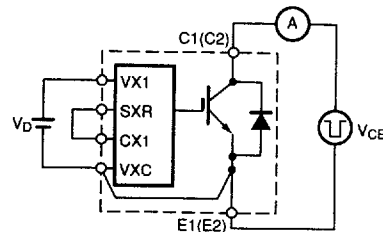

Figure 4  $I_{CES}$  Test

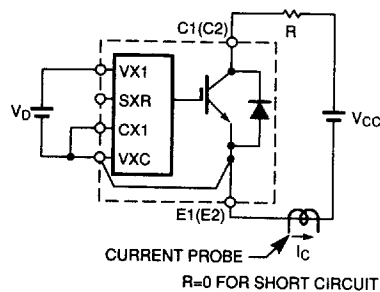

Figure 5 Over Current and Short Circuit Test

