



The Future of Analog IC Technology™

MP2104

1.7MHz, 600mA Synchronous Step-Down Converter

DESCRIPTION

The MP2104 is a 1.7MHz constant frequency, current mode, PWM step-down converter. The device integrates a main switch and a synchronous rectifier for high efficiency without an external Schottky diode. It is ideal for powering portable equipment that runs from a single cell Lithium-Ion (Li+) battery. The MP2104 can supply 600mA of load current from a 2.5V to 6V input voltage. The output voltage for the MP2104DJ can be regulated as low as 0.6V, while the output voltages of the MP2104DJ-1.5 and MP2104DJ-1.8 are fixed at 1.5V and 1.8V, respectively. The MP2104 can also run at 100% duty cycle for low dropout applications.

The MP2104 is available in a low profile (1mm) 5-pin, TSOT package.

ORDERING INFORMATION

Part Number	Output Voltage
MP2104DJ-1.5	$V_{OUT} = 1.5V$
MP2104DJ-1.8	$V_{OUT} = 1.8V$
MP2104DJ	$V_{OUT} = 0.6V \text{ to } 6V$

EVALUATION BOARD REFERENCE

Board Number	Dimensions
EV2104DJ-00A	2.0"X x 2.0"Y x 0.5"Z

FEATURES

- High Efficiency: Up to 95%
- 1.7MHz Constant Switching Frequency
- 600mA Available Load Current
- 2.5V to 6V Input Voltage Range
- Output Voltage as Low as 0.6V
- 100% Duty Cycle in Dropout
- Current Mode Control
- Short Circuit Protection
- Thermal Fault Protection
- $0.1\mu A$ Shutdown Current
- 1.5V and 1.8V Fixed Output Versions
- Space Saving 5-Pin TSOT23 Package

APPLICATIONS

- Cellular and Smart Phones
- Microprocessors and DSP Core Supplies
- PDAs
- MP3 Players
- Digital Still and Video Cameras
- Portable Instruments

"MPS" and "The Future of Analog IC Technology" are Trademarks of Monolithic Power Systems, Inc.

TYPICAL APPLICATION

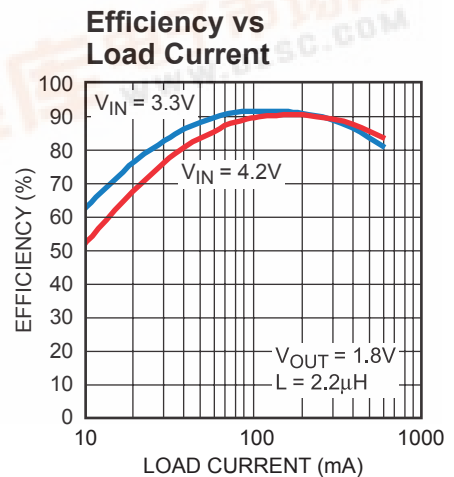
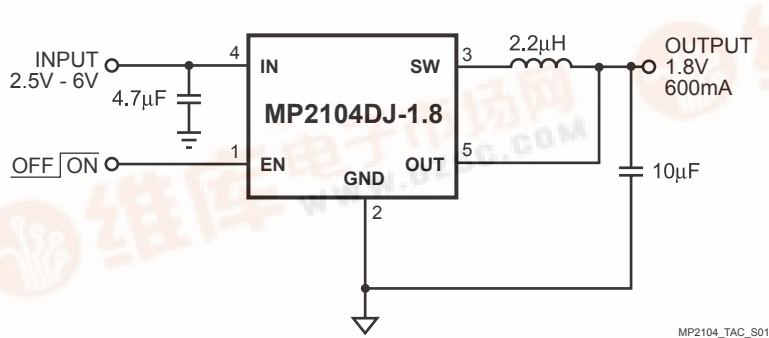

PACKAGE REFERENCE

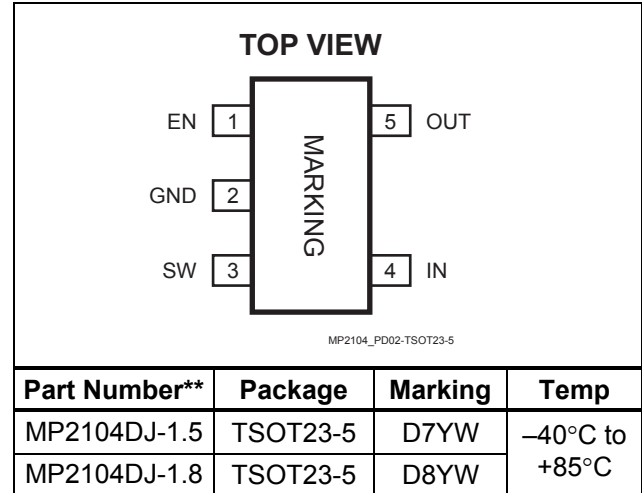
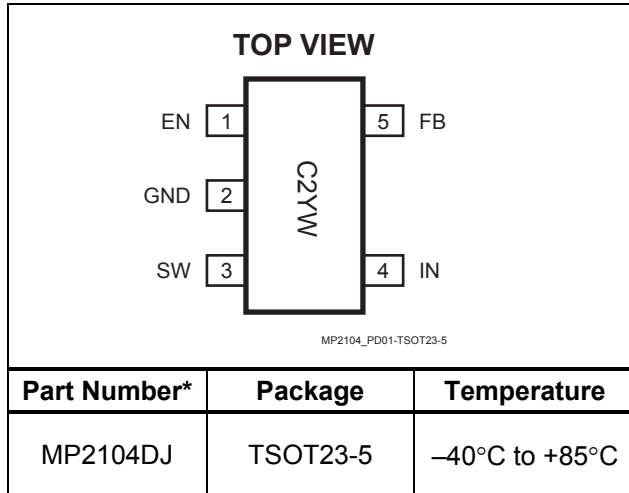

* For Tape & Reel, add suffix -Z (eg. MP2104DJ-Z)
For Lead Free, add suffix -LF (eg. MP2104DJ-LF-Z)

** For Tape & Reel, add suffix -Z (eg. MP2104DJ-1.5-Z)
For Lead Free, add suffix -LF (eg. MP2104DJ-1.5-LF-Z)

ABSOLUTE MAXIMUM RATINGS ⁽¹⁾

V_{IN} to GND	-0.3V to +6.5V
V_{SW} to GND	-0.3V to V_{IN} +0.3V
V_{FB} , V_{EN} to GND	-0.3V to +6.5V
SW Peak Current	1.4A
Junction Temperature	+150°C
Lead Temperature ⁽²⁾	+260°C
Storage Temperature	-65°C to +150°C

Recommended Operating Conditions ⁽³⁾

Supply Voltage V_{IN}	2.5V to 6V
Output Voltage V_{OUT}	0.6V to 6V
Operating Temperature	-40°C to +85°C

Thermal Resistance ⁽⁴⁾	θ_{JA}	θ_{JC}
TSOT23-5	220	110

Notes:

- Exceeding these ratings may damage the device.
- For recommended IR reflow temperature information, refer to MPS document MP2104_IRRTP.
- The device is not guaranteed to function outside of its operating conditions.
- Measured on approximately 1" square of 1 oz copper.

ELECTRICAL CHARACTERISTICS ⁽⁵⁾

$V_{IN} = V_{EN} = 3.6V$, $T_A = +25^\circ C$, unless otherwise noted.

Parameter	Symbol	Condition	Min	Typ	Max	Units
Supply Current		$V_{EN} = V_{IN}$, $V_{FB} = 0.65V$		400	600	μA
Shutdown Current		$V_{EN} = 0V$, $V_{IN} = 6V$		0.01	1	μA
IN Under Voltage Lockout Threshold		Rising Edge	2.10	2.27	2.45	V
IN Under Voltage Lockout Hysteresis				55		mV
Regulated FB Voltage		$T_A = +25^\circ C$, MP2104DJ	0.588	0.600	0.612	V
		$-40^\circ C \leq T_A \leq +85^\circ C$	0.582	0.600	0.618	
FB Input Bias Current		$V_{FB} = 0.65V$, MP2104DJ	-50	0.5	+50	nA

ELECTRICAL CHARACTERISTICS *(continued)* ⁽⁵⁾
 $V_{IN} = V_{EN} = 3.6V$, $T_A = +25^{\circ}C$, unless otherwise noted.

Parameter	Symbol	Condition	Min	Typ	Max	Units
Regulated Output Voltage		MP2104DJ-1.5 $I_{OUT} = 50mA$ $-40^{\circ}C \leq T_A \leq +85^{\circ}C$	1.455	1.500	1.545	V
		MP2104DJ-1.8 $I_{OUT} = 50mA$ $-40^{\circ}C \leq T_A \leq +85^{\circ}C$	1.746	1.800	1.854	
PFET On Resistance		$I_{SW} = 100mA$		0.44		Ω
NFET On Resistance		$I_{SW} = -100mA$		0.29		Ω
SW Leakage Current		$V_{EN} = 0V$, $V_{IN} = 6V$ $V_{SW} = 0V$ or $6V$	-1		+1	μA
PFET Current Limit		Duty Cycle = 100%, Current Pulse Width < 1ms	0.7	1.0	1.35	A
Oscillator Frequency			1.26	1.70	2.08	MHz
Thermal Shutdown Trip Threshold				145		$^{\circ}C$
EN Trip Threshold		$-40^{\circ}C \leq T_A \leq +85^{\circ}C$	0.3	0.96	1.5	V
EN Input Current		$V_{EN} = 0V$ to $6V$	-1		+1	μA

Notes:

 5) 100% production test at $+25^{\circ}C$. Typical and temperature specifications are guaranteed by design and characterization.

TYPICAL PERFORMANCE CHARACTERISTICS

$V_{IN} = 3.3V$, $V_{OUT} = 1.8V$, $L1 = 10\mu H$, $C1 = 4.7\mu F$, $C3 = 10\mu F$, $T_A = +25^\circ C$, unless otherwise noted.

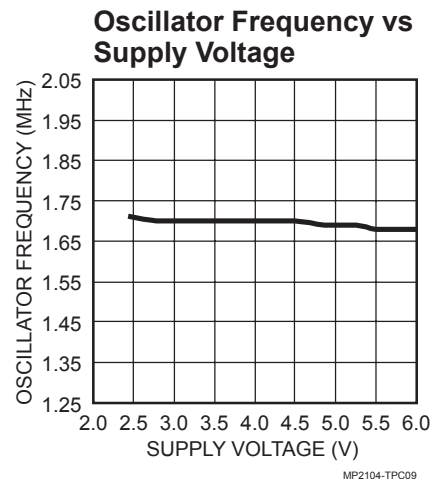
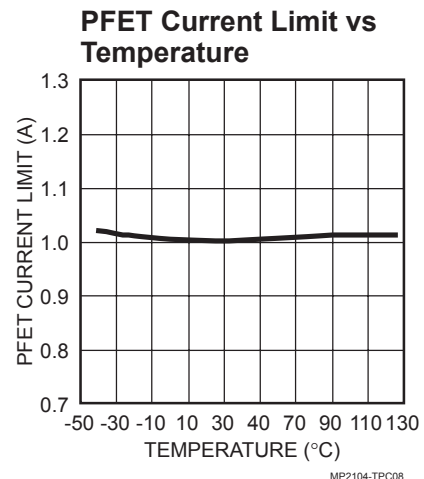
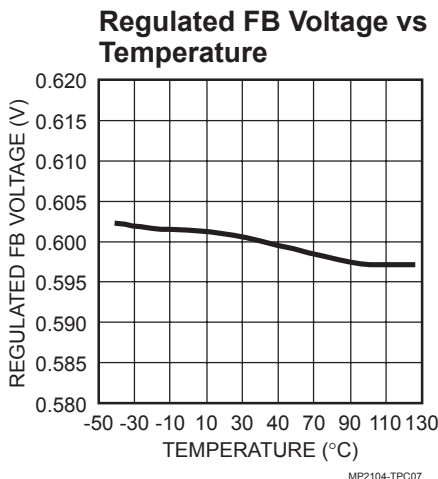
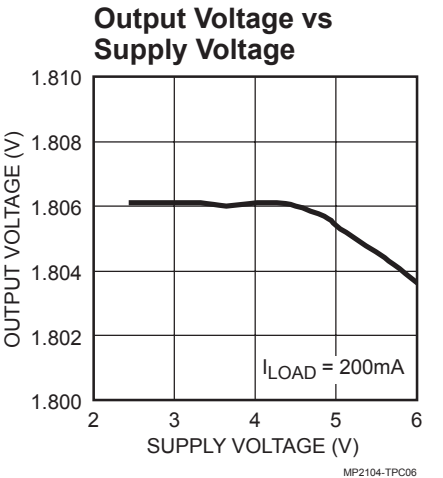
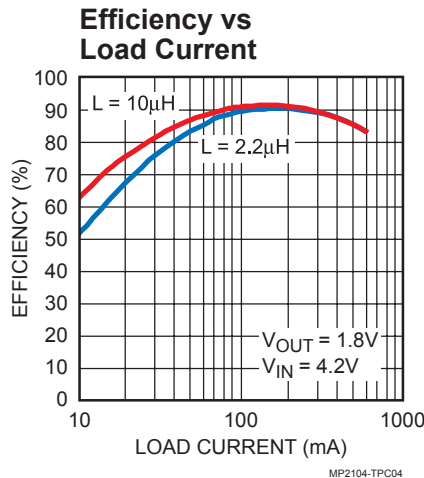
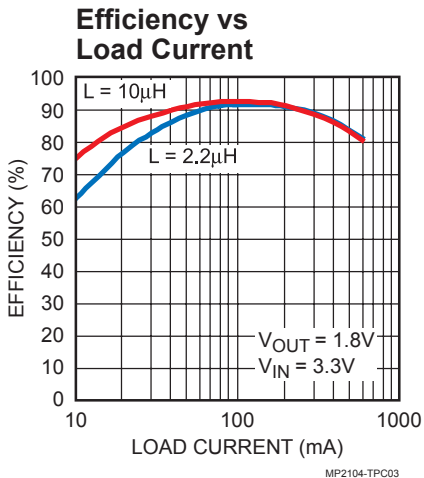
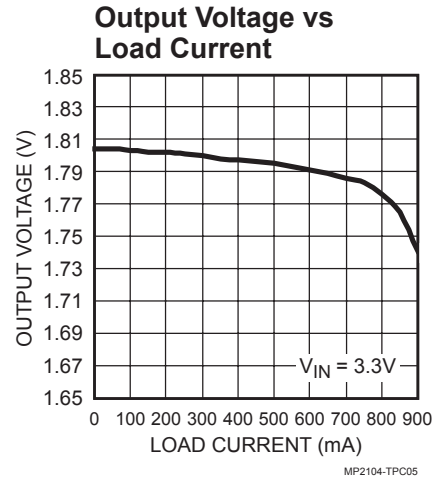
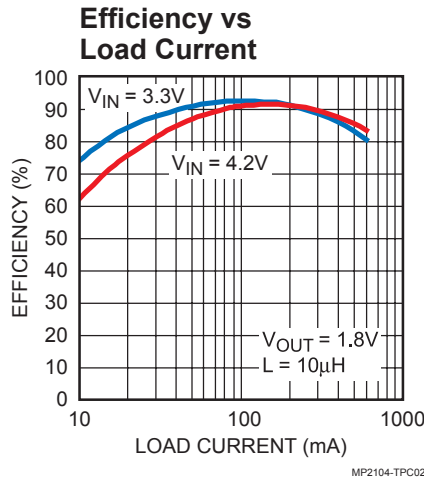
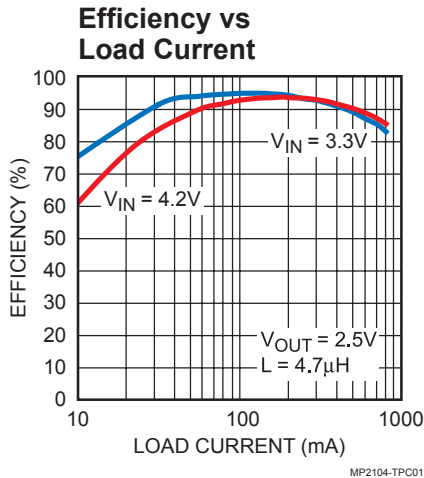

TYPICAL PERFORMANCE CHARACTERISTICS *(continued)*
 $V_{IN} = 3.3V$, $V_{OUT} = 1.8V$, $L1 = 10\mu H$, $C1 = 4.7\mu F$, $C3 = 10\mu F$, $T_A = +25^\circ C$, unless otherwise noted.

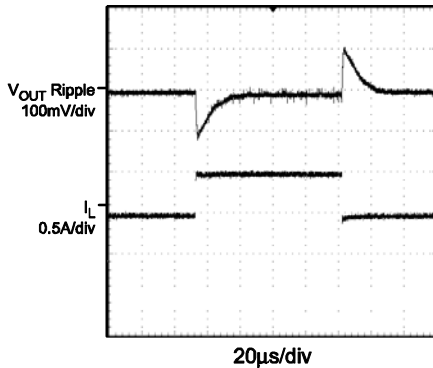
Load Transient
 $V_{IN} = 3.3V$, $V_{OUT} = 1.8V$,
 $I_{LOAD} = 0 - 500mA$ Step

MP2104-WF01

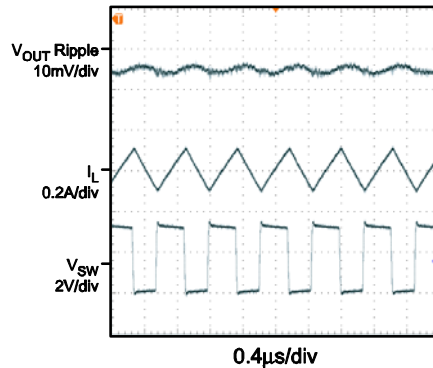
Light Load Operation
 $V_{IN} = 3.3V$, $V_{OUT} = 1.8V$,
 $I_{LOAD} = 0A$

MP2104-WF02

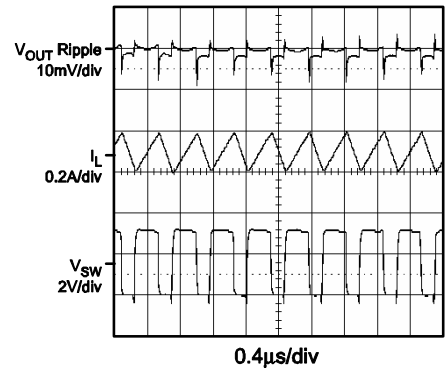
Heavy Load Operation
 $V_{IN} = 3.3V$, $V_{OUT} = 1.8V$,
 $I_{LOAD} = 600mA$

MP2104-WF03

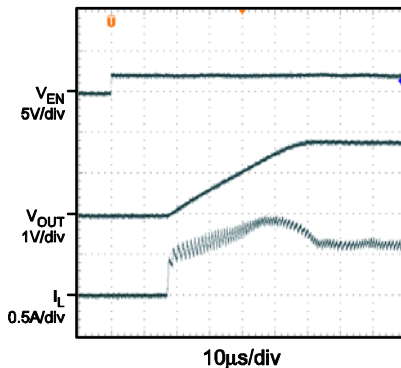
Startup from Shutdown
 $V_{IN} = 2.5V$, $V_{OUT} = 1.8V$,
 $I_{LOAD} = 600mA$ Resistive

MP2104-WF04

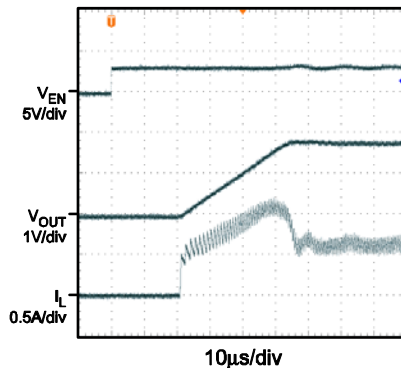
Startup from Shutdown
 $V_{IN} = 3.3V$, $V_{OUT} = 1.8V$,
 $I_{LOAD} = 600mA$ Resistive

MP2104-WF05

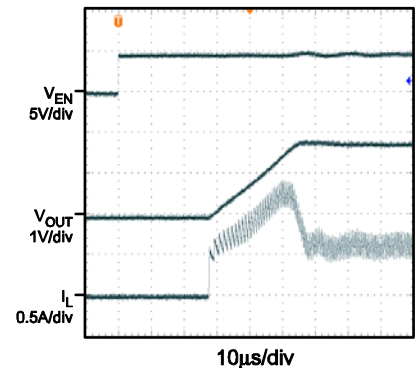
Startup from Shutdown
 $V_{IN} = 5V$, $V_{OUT} = 1.8V$,
 $I_{LOAD} = 600mA$ Resistive

MP2104-WF06

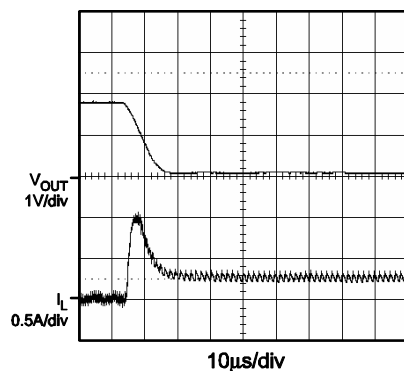
Short Circuit Protection
 $V_{IN} = 3.3V$, $V_{OUT} = 1.8V$,
 No Load

MP2104-WF07

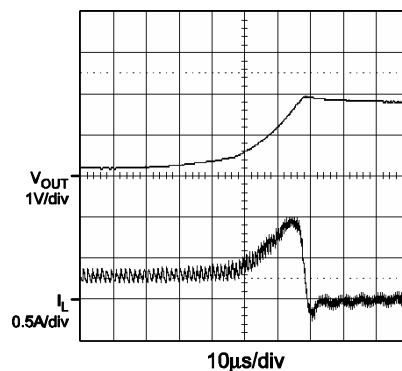
Short Circuit Recovery
 $V_{IN} = 3.3V$, $V_{OUT} = 1.8V$,
 No Load

MP2104-WF08

PIN FUNCTIONS

Pin #	Name	Description
1	EN	Regulator Enable Control Input. Drive EN above 1.5V to turn on the MP2104. Drive EN below 0.3V to turn it off (shutdown current < 0.1µA).
2	GND	Ground.
3	SW	Power Switch Output. Inductor connection to drains of the internal PFET and NFET switches.
4	IN	Supply Input. Bypass to GND with a 2.2µF or greater ceramic capacitor.
5	FB	Feedback Input (MP2104DJ). Connect FB to the center point of the external resistor divider. The feedback threshold voltage is 0.6V.
5	OUT	Output Voltage Sense Input (MP2104DJ-1.5 and MP2104DJ-1.8). An internal resistor divider is connected to this pin to set the proper output voltage.

OPERATION

The MP2104 is a constant frequency current mode PWM step-down converter. The MP2104 is optimized for low voltage, Li-Ion battery powered applications where high efficiency and small size are critical. The MP2104 uses an external resistor divider to set the output voltage from 0.6V to 6V. The device integrates both a main switch and a synchronous rectifier, which provides high efficiency and eliminates

an external Schottky diode. The MP2104 can achieve 100% duty cycle. The duty cycle D of a step-down converter is defined as:

$$D = T_{ON} \times f_{OSC} \times 100\% \approx \frac{V_{OUT}}{V_{IN}} \times 100\%$$

Where T_{ON} is the main switch on time, f_{OSC} is the oscillator frequency (1.7MHz), V_{OUT} is the output voltage and V_{IN} is the input voltage.

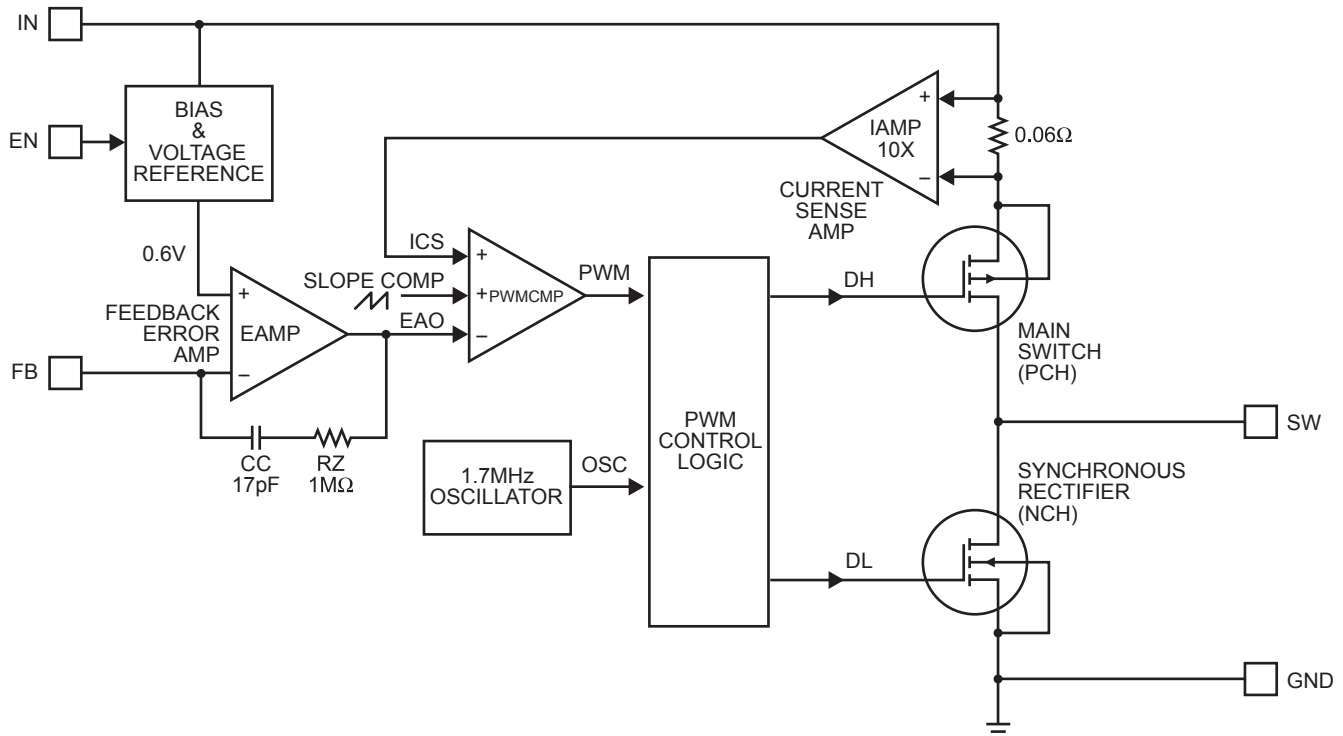

MP2104_BD01

Figure 1—Functional Block Diagram (MP2104)

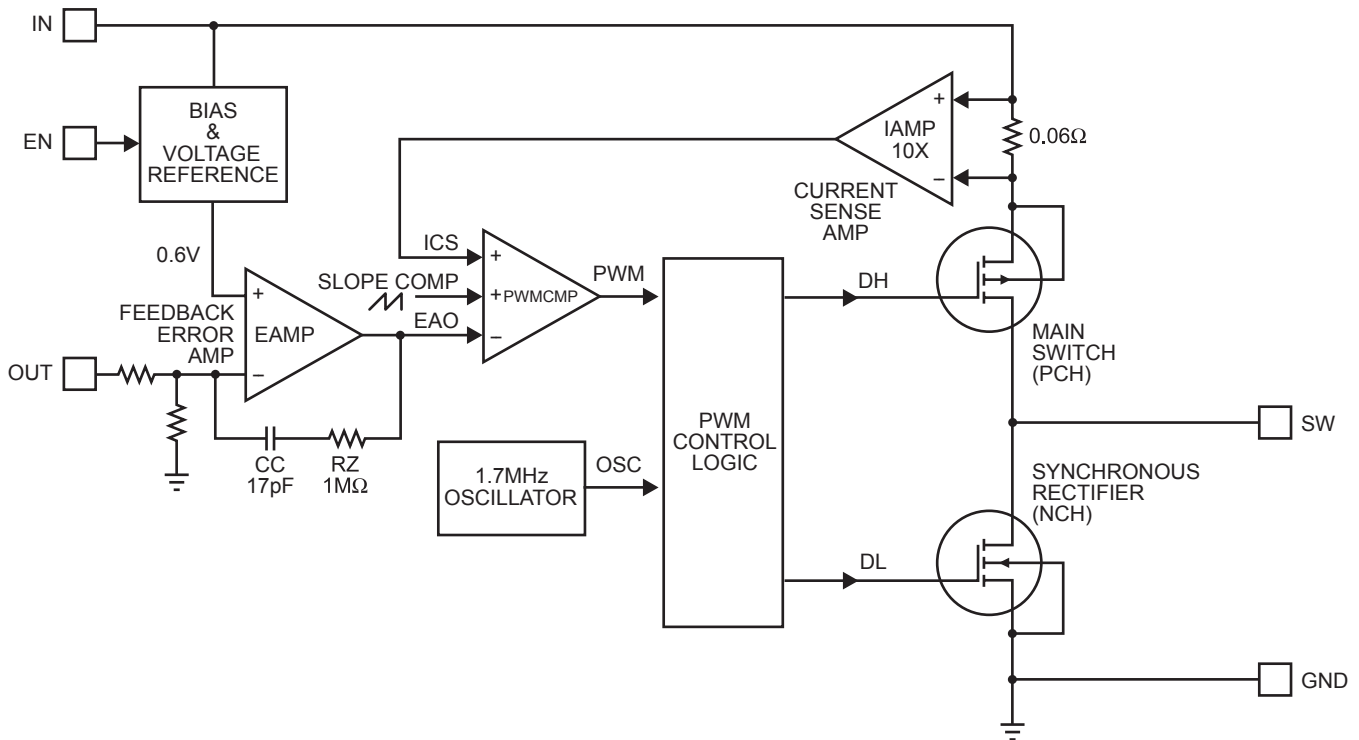

MP2104_BD01

Figure 2—Functional Block Diagram (MP2104DJ-1.5 / MP2104DJ-1.8)

Current Mode PWM Control

Slope compensated current mode PWM control provides stable switching and cycle-by-cycle current limit for superior load and line response and protection of the internal main switch and synchronous rectifier. The MP2104 switches at a constant frequency (1.7MHz) and regulates the output voltage. During each cycle the PWM comparator modulates the power transferred to the load by changing the inductor peak current based on the feedback error voltage. During normal operation, the main switch is turned on for a certain time to ramp the inductor current at each rising edge of the internal oscillator, and switched off when the peak inductor current is above the error voltage. When the main switch is off, the synchronous rectifier will be turned on immediately and stay on until either the next cycle starts.

Dropout Operation

The MP2104 allows the main switch to remain on for more than one switching cycle and increases the duty cycle while the input voltage is dropping close to the output voltage. When the duty cycle reaches 100%, the main switch is held on continuously to deliver current to the output up to

the PFET current limit. The output voltage then is the input voltage minus the voltage drop across the main switch and the inductor.

Short Circuit Protection

The MP2104 has short circuit protection. When the output is shorted to ground, the oscillator frequency is reduced to prevent the inductor current from increasing beyond the PFET current limit. The PFET current limit is also reduced to lower the short circuit current. The frequency and current limit will return to the normal values once the short circuit condition is removed and the feedback voltage reaches 0.6V.

Maximum Load current

The MP2104 can operate down to 2.5V input voltage, however the maximum load current decreases at lower input due to large IR drop on the main switch and synchronous rectifier. The slope compensation signal reduces the peak inductor current as a function of the duty cycle to prevent sub-harmonic oscillations at duty cycles greater than 50%. Conversely the current limit increases as the duty cycle decreases.



APPLICATION INFORMATION

Output Voltage Setting (MP2104DJ)

The external resistor divider sets the output voltage (see Figure 3). The feedback resistor R1 also sets the feedback loop bandwidth with the internal compensation capacitor (see Figure 1).

Choose R1 around 300kΩ for optimal transient response. R2 is then given by:

$$R2 = \frac{R1}{\frac{V_{OUT}}{0.6V} - 1}$$

Table 1—Resistor Selection vs. Output Voltage Setting

V _{OUT}	R1	R2
1.2V	300kΩ (1%)	300kΩ (1%)
1.5V	300kΩ (1%)	200kΩ (1%)
1.8V	300kΩ (1%)	150kΩ (1%)
2.5V	300kΩ (1%)	95.3kΩ (1%)

Inductor Selection

A 1μH to 10μH inductor with DC current rating at least 25% higher than the maximum load current is recommended for most applications. For best efficiency, the inductor DC resistance shall be <200mΩ. See Table 2 for recommended inductors and manufacturers. For most designs, the inductance value can be derived from the following equation:

$$L = \frac{V_{OUT} \times (V_{IN} - V_{OUT})}{V_{IN} \times \Delta I_L \times f_{OSC}}$$

Where ΔI_L is the inductor ripple current. Choose inductor ripple current approximately 30% of the maximum load current, 600mA.

The maximum inductor peak current is:

$$I_{L(MAX)} = I_{LOAD} + \frac{\Delta I_L}{2}$$

Under light load conditions below 100mA, larger inductance is recommended for improved efficiency. Table 3 lists inductors recommended for this purpose.

Table 2—Suggested Surface Mount Inductors

Manufacturer	Part Number	Inductance (μH)	Max DCR (Ω)	Saturation Current (A)	Dimensions LxWxH (mm ³)
Coilcraft	LP1704-222M	2.2	0.07	1.7	6.5x5.3x2
Toko	D312C	2.2	0.14	1.0	3.6x3.6x1
Sumida	CDRH3D16	2.2	0.072	1.2	4x4x1.8
Taiyo Yuden	LBC2518	2.2	0.13	0.6	2.5x1.8x1.8

Table 3—Inductors for Improved Efficiency at 25mA, 50mA, under 100mA Load.

Manufacturer	Part Number	Inductance (μH)	Max DCR (Ω)	Saturation Current (A)	I _{RMS} (A)
Coilcraft	DO1605T-103MX	10	0.3	1.0	0.9
Murata	LQH4C100K04	10	0.2	1.2	0.8
Sumida	CMD4D06-100	10	0.3	0.7	0.5
Sumida	CR32-100	10	0.2	1.0	0.7
Sumida	CR54-100	10	0.1	1.2	1.4

Input Capacitor Selection

The input capacitor reduces the surge current drawn from the input and switching noise from the device. The input capacitor impedance at the switching frequency shall be less than input source impedance to prevent high frequency switching current passing to the input. Ceramic capacitors with X5R or X7R dielectrics are highly recommended because of their low ESR and small temperature coefficients. For most applications, a 4.7µF capacitor is sufficient.

Output Capacitor Selection

The output capacitor keeps output voltage ripple small and ensures regulation loop stable. The output capacitor impedance shall be low at the switching frequency. Ceramic capacitors with X5R or X7R dielectrics are recommended. The output ripple ΔV_{OUT} is approximately:

$$\Delta V_{OUT} \leq \frac{V_{OUT} \times (V_{IN} - V_{OUT})}{V_{IN} \times f_{OSC} \times L} \times \left(ESR + \frac{1}{8 \times f_{OSC} \times C3} \right)$$

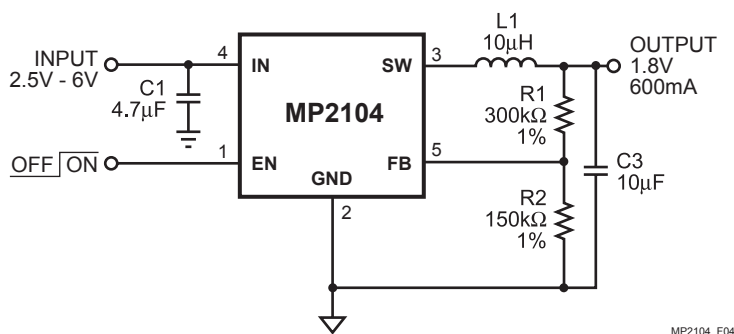

Figure 4— $V_{IN} = 2.5V$ to $6V$, $V_{OUT} = 1.8V$, $I_{LOAD} = 600mA$ Step-Down Circuit (L = 10µH for Higher Light-Load Efficiency)

PC Board Layout

The high current paths (GND, IN and SW) should be placed very close to the device with short, direct and wide traces. Input capacitor C1 needs to be as close as possible to the IN and GND pins. The external feedback resistors shall be placed next to the FB pin. Keep the switching node SW short and away from the feedback network. Figure 3 illustrates an example of PCB layout and signal routing.

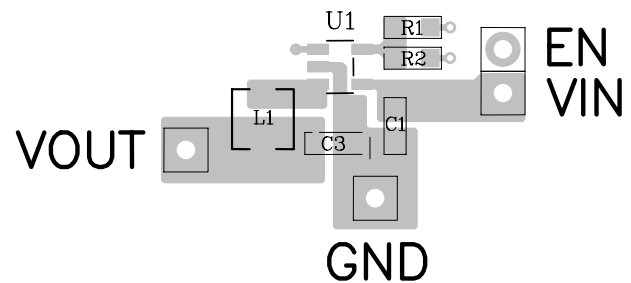
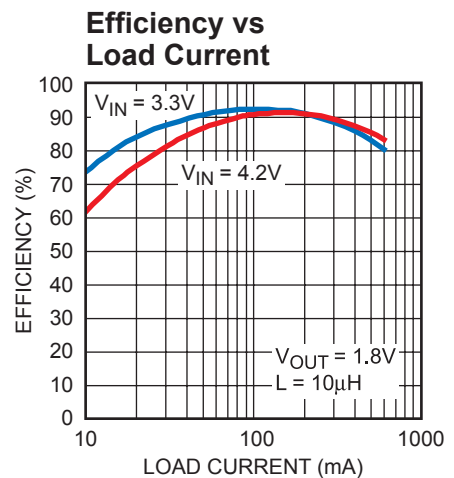

Figure 3—MP2104 Suggested Layout

For the fixed output versions (MP2104DJ-1.5 and MP2104-1.8), R1 is shorted and R2 is open.



MP2104-EC02

NOTICE: MPS believes the information in this document to be accurate and reliable. However, it is subject to change without notice. Contact MPS for current specifications. MPS encourages users of its products to ensure that third party Intellectual Property rights are not infringed upon when integrating MPS products into any application. MPS cannot assume any legal responsibility for any said applications.

PACKAGE INFORMATION

TSOT23-5

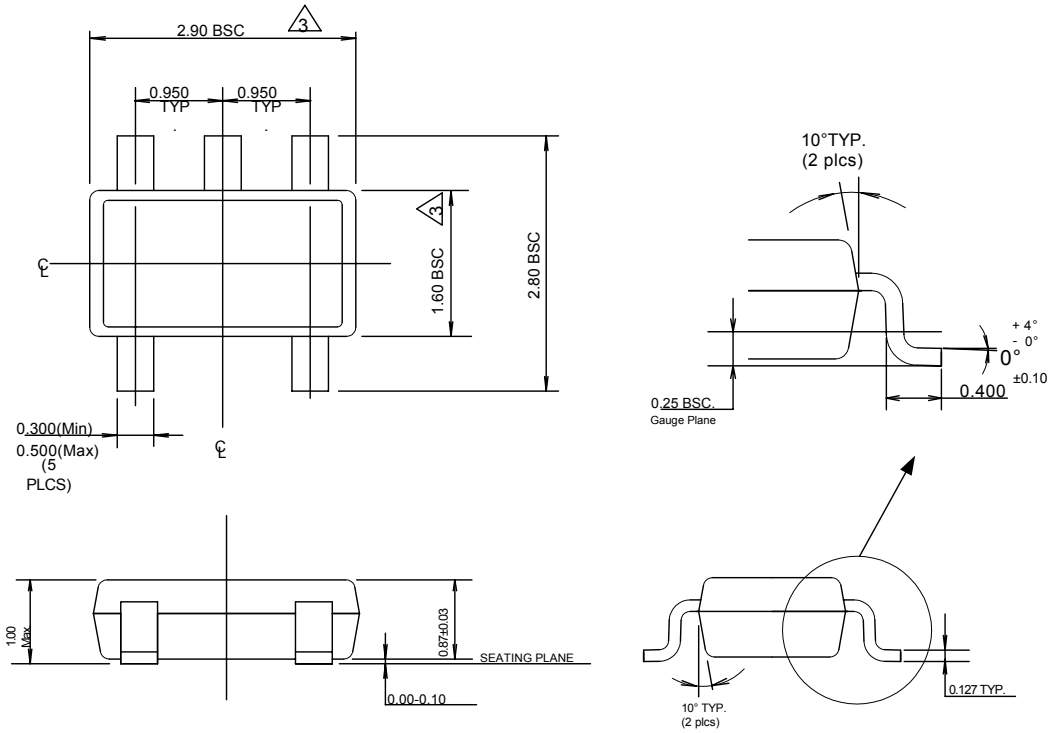

NOTICE: The information in this document is subject to change without notice. Please contact MPS for current specifications. Users should warrant and guarantee that third party Intellectual Property rights are not infringed upon when integrating MPS products into any application. MPS will not assume any legal responsibility for any said applications.