

DARK CURRENT vs. VOLTAGE

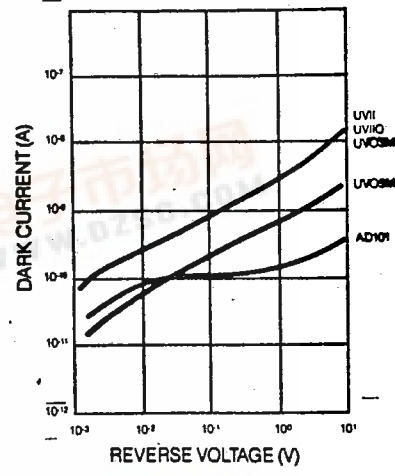

RESPONSIVITY CURVES (TYPICAL)

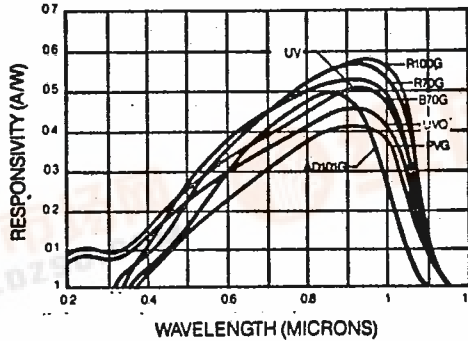

TO-Package Photodiodes

TO-Package Photodiodes

All silicon planar photosensors are available in cell form for mounting onto printed circuit boards, packages or flex circuits. Substrate contacts are suitable for solder or epoxy attach. Anode contacts can be soldered or wire-bonded depending upon metallurgy requirements. For long wavelengths (900-1100 nm), surface-mount rear-entrance cells are available for customization to each application.

TO-PACKAGED PHOTODIODES

TYPE NUMBER	PACKAGE OUTLINE	ELEMENT DIMENSION (mm)	PHOTO-SENSITIVE AREA (mm ²)	RESPONSE CURVE TYPE	PEAK RESPONSE WAVELENGTH (nm)	RESPONSIVITY ¹⁾			I _{sc} ²⁾ (mA)	
						254 nm (A/W)	550 nm (A/W)	PEAK (A/W)		
UV ENHANCED										
ADC-UVII	P11	10.0 x 10.0	100	UV	190-1100	950	.09	0.31	0.52	3.0C
ADC-UVIIQ	P11	10.0 x 10.0	100	UVQ	200-1100	950	.09	0.28	0.48	3.0C
ADC-UV03M	T03	10.0 x 10.0	100	UVQ	200-1100	950	.09	0.28	0.48	3.0C
ADC-UV05M	T05	2.14 Dia.	3.6	UVQ	200-1100	950	.09	0.28	0.48	0.11
BLUE/VISIBLE RESPONSE										
11BH18M	T018	1.02 x 1.02	1.0	B70G	320-1100	950	—	0.34	0.54	0.03
22BH18M	T018	1.52 x 1.52	2.3	B70G	320-1100	950	—	0.34	0.54	0.07
33BH05M	T05	2.29 x 2.29	5.2	B70G	320-1100	950	—	0.34	0.54	0.16
44BH05M	T05	4.17 x 4.17	17	B70G	320-1100	950	—	0.34	0.54	0.52
68BH08M	T08	8.38 x 6.45	53	B70G	320-1100	950	—	0.34	0.54	1.6C
110BH3M	T03	10.0 x 10.0	94	B70G	320-1100	950	—	0.34	0.54	2.82
NEAR IR RESPONSE, HIGH PERFORMANCE										
11PS18M	T018	1.02 x 1.02	1.0	R70G	320-1100	950	—	0.31	0.58	0.03
22PS18M	T018	1.52 x 1.52	2.3	R70G	320-1100	950	—	0.31	0.58	0.07
33PS05M	T05	2.29 x 2.29	5.2	R70G	320-1100	950	—	0.31	0.58	0.16
44PS05M	T05	4.17 x 4.17	17	R70G	320-1100	950	—	0.31	0.58	0.52
68PS08M	T08	8.38 x 6.45	53	R70G	320-1100	950	—	0.31	0.58	1.6C
110PS3M	T03	10.0 x 10.0	94	R70G	320-1100	950	—	0.31	0.58	2.82
310PS3M	T03/3	20 DIAM	317	R100G	320-1100	950	—	0.31	0.59	9.5
NEAR IR RESPONSE										
11PH18M	T018	1.02 x 1.02	1.0	R70G	320-1100	950	—	0.31	0.58	0.03
22PH18M	T018	1.52 x 1.52	2.3	R70G	320-1100	950	—	0.31	0.58	0.07
33PH05M	T05	2.29 x 2.29	5.2	R70G	320-1100	950	—	0.31	0.58	0.16
44PH05M	T05	4.17 x 4.17	17	R70G	320-1100	950	—	0.31	0.58	0.52
68PH08M	T08	8.38 x 6.45	53	R70G	320-1100	950	—	0.31	0.58	1.6C
110PH3M	T03	10.0 x 10.0	94	R70G	320-1100	950	—	0.31	0.58	2.82
AD101	T05	2.14 Dia.	3.6	AD101G	320-1060	875	—	0.27	0.50	0.11
GENERAL PURPOSE										
11PV18M	T018	1.02 x 1.02	1.0	PVG	250-1050	900	—	0.22	0.42	0.03
22PV18M	T018	1.52 x 1.52	2.3	PVG	250-1050	900	—	0.22	0.42	0.07
33PV05M	T05	2.29 x 2.29	5.2	PVG	250-1050	900	—	0.22	0.42	0.16
44PV05M	T05	4.17 x 4.17	17	PVG	250-1050	900	—	0.22	0.42	0.52
68PV08M	T08	8.38 x 6.45	53	PVG	250-1050	900	—	0.22	0.42	1.6C
110PV3M	T03	10.0 x 10.0	94	PVG	250-1050	900	—	0.22	0.42	2.82

1) MINIMUM RESPONSIVITY IS 90% OF TYPICAL RESPONSIVITY. 2) SHORT CIRCUIT CURRENT (I_{sc}) IS MEASURED WITH 10 mW/cm² OF OPTICAL P



DARK CURRENT vs. VOLTAGE

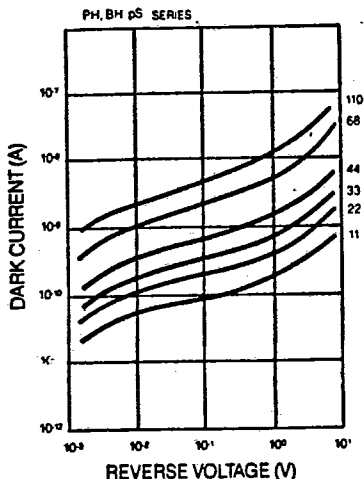

CAPACITANCE vs. VOLTAGE

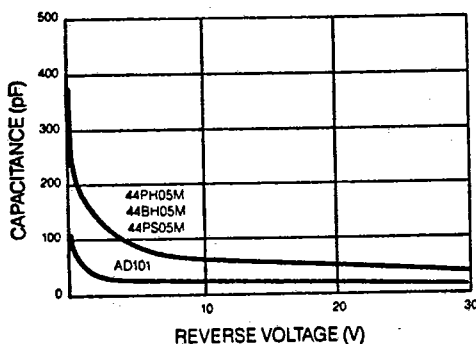

DARK CURRENT vs. TEMPERATURE

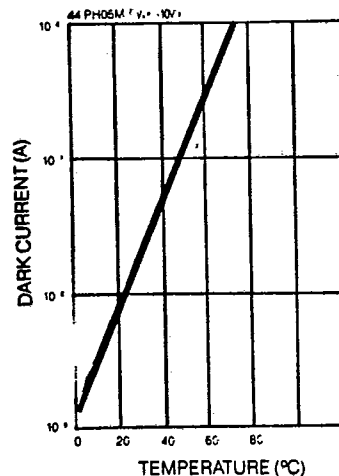

DARK CURRENT			BREAKDOWN VOLT.	SHUNT RESISTANCE	TYPICAL CAPACITANCE			RISE TIME ³⁾		NEP	D*
$V_R = -0.01V$	$V_R = -1.0V$	$V_R = -10V^{(4)}$	$I_{DR} = 10\mu A$	TYP.	$V_R = 0V$	$V_R = -1V$	$V_R = -10V$	$V_R = 0$	$V_R = -10V$	TYP.	TYP.
MAX. (nA)	MAX. (nA)	MAX. (nA)	MIN. (V)	(Mohm)	(pF)	(pF)	(pF)	(ns)	(ns)	($W\sqrt{Hz}$)	($cm\sqrt{Hz/W}$)

0.20	2.00	6.32	7	57	2191	1052	374	500	40	1.68E-14	6.0E+13
0.20	2.00	6.32	7	57	2191	1052	374	500	40	1.68E-14	6.0E+13
0.20	2.00	6.32	7	57	2191	1052	374	500	40	1.68E-14	6.0E+13
0.04	0.40	1.26	20	275	79	38	13	450	3	7.63E-15	2.5E+13

0.15	20	40	70	200	23	11	4	450	2	8.94E-15	1.1E+13
0.30	40	80	70	100	51	24	9	450	2	1.28E-14	1.2E+13
0.50	86	170	30	60	114	55	20	450	3	1.63E-14	1.4E+13
1.20	280	552	12	30	380	183	65	450	9	2.31E-14	1.8E+13
2.20	550	1100	6	10	1171	562	200	460	25	4.00E-14	1.8E+13
4.40	1100	2200	3	5	2060	989	352	500	40	5.66E-14	1.7E+13

0.10	1.0	2.0	125	200	23	11	4	450	2	8.94E-15	1.1E+13
0.20	1.8	5.0	80	100	51	24	9	450	2	1.26E-14	1.2E+13
0.33	6.0	14.0	50	60	110	55	20	450	3	1.63E-14	1.4E+13
0.67	16.0	36.0	20	30	380	180	65	450	9	2.31E-14	1.8E+13
2.50	70.0	140.0	10	10	1200	560	200	460	25	4.00E-14	1.8E+13
5.00	150.0	220.0	5	5	2060	990	350	500	40	5.66E-14	1.7E+13
10.00	20.0	100.0	25	5	1950	820	280	500	35	5.66E-14	3.1E+13

0.10	3	15	100	200	23	11	4	450	2	8.94E-15	1.1E+13
0.20	5	25	70	100	51	24	9	450	2	1.26E-14	1.2E+13
0.33	6	30	40	60	110	55	20	450	3	1.63E-14	1.4E+13
0.67	20	60*	25	30	380	180	65	450	9	2.31E-14	1.8E+13
2.50	140	400*	7	10	1200	560	200	460	25	4.00E-14	1.8E+13
5.00	300	500*	4	5	2050	990	350	500	40	5.66E-14	1.7E+13
0.10	3.0	30 ($V_R = -50$)	100	200	100	53	19	400	$V_R = -50V$	8.94E-15	2.1E+13

15	2000	4000	7	20	130	67	24	600	500	2.83E-14	3.6E+12
30	4000	8000	7	10	300	150	55	600	500	4.00E-14	3.8E+12
50	8600	17200	3	6	670	340	120	610	500	5.16E-14	4.4E+12
120	27600	55200	1	3	2200	1100	410	640	500	7.30E-14	5.7E+12
22*	55000	110000	1	1	6900	3490	1260	950	550	1.26E-13	5.8E+12
44			1	1	12000	6100	2200	1400	600	1.79E-13	5.4E+12

Custom Spectral Response

Advanced Detector Corporation offers devices with optimized spectral response in the UV, blue, or red spectral regions.

Custom spectral response is achieved using glass or interference filters which provide the optics engineer with control of device responsivity characteristics.

Military/Aerospace Products

Advanced Detector Corporation has provided high reliability products to the military and aerospace industry for decades. Our quality assurance program has been developed to meet the requirements of Mil-Q-9858A. ADC's quality assurance program, described in document ADC 91-6064, outlines the quality assurance policies implemented on all products and is available upon request.

In addition to our standard quality program, additional Mil-spec tests include reverse or forward bias, burn-in, gross and fine leak tests, acceleration, vibration, shock, humidity, thermal cycle and thermal shock.

Like all other ADC products, custom capability is readily available including application and design assistance.

Calibration Services

Advanced Detector Corporation offers calibration services for ADC and other photodiodes, sunsensors and solar cells in the near-ultraviolet, visible and near-infrared wavelength regions. A general description of the different calibration services is listed below.

Absolute Responsivity

Absolute responsivity is defined as the short-circuit current for a given light input power at a specific wavelength.

This parameter is often a critical specification for a photodiodes in electro-optic systems, but standards are not readily available. For this reason ADC offers an NBS-traceable calibration service for photodiodes.

This service consists of measuring the absolute response of photodiodes using a 23-wavelength filter wheel with a mercury-xenon light source covering a wavelength range of 200 nm to 1100 nm. T

ducibility of responsivity measurement typically $\pm 0.1\%$. The absolute responsivity accuracy is limited by the absolute accuracy of the NBS responsivity transfer standards, typically \pm maximum error. Data curves and a tabular presentation of the results are provided, along with a summary of standard performance parameters including capacitance, dark current, shunt resistance, and breakdown voltage.

A second method, which is based on NBS-traceable electrical substitution radiometry, is also available at discrete wavelengths. This calibration can have an absolute accuracy within $\pm 0.2\%$ maximum error depending on the test wavelength. Limited wavelengths are

CUSTOM SPECTRAL RESPONSE

TYPE NUMBER	PACKAGE OUTLINE	ELEMENT DIMENSIONS (mm ²)	PHOTO-SENSITIVE AREA (mm)	RESPONSE CURVE TYPE	RESPONSE RANGE (nm)	PEAK WAVE-LENGTH (nm)	RESPONSIVITY ¹⁾ PEAK (A/W)
33PSF105M	C16	2.3 x 2.3	5.2	F1	380-480	440	0.13
33PSF205M	C16	2.3 x 2.3	5.2	F2	690-1050	730	0.55
33PSF305M	C16	2.3 x 2.3	5.2	F3	810-1060	970	0.52
33PSF405M	C16	2.3 x 2.3	5.2	"CIE"	480-660	540	0.23
100QE	C4	6.3 DIAM	31	100QE	190-1100	975	0.74

1) MINIMUM RESPONSIVITY IS 90% OF TYPICAL RESPONSIVITY.

available since this calibration technique requires the stable, collimated light source typical of HeNe lasers.

100% Quantum Efficiency Device

A unique photodiode assembly designed by ADC offers 100% external (+0%, -2%) quantum efficiency from 550nm to 950 nm. The fact that it is 100% efficient in converting optical power to electrical current makes its calibration independent of any other standards. The responsivity (R) is simply:

$$R = L/1.24$$

where R is measured in amperes per watt and the wavelength L is between 0.550 and 0.950 microns. For more information, refer to the section on custom spectral response photodiodes.

MILITARY/AEROSPACE (MIL-STD.)

TYPE NUMBER	PACKAGE OUTLINE	ELEMENT DIMENSIONS (mm ²)	PHOTO-SENSITIVE AREA (mm)	RESPONSE CURVE TYPE	RESPONSE RANGE (nm)	PEAK WAVE-LENGTH (nm)	RESPONSIVITY ¹⁾ 550 nm (A/W)	PEAK (A/W)	I _{sc} ²⁾ (mA)
33PH05MIL	T05	2.3 X 2.3	5.2	R70G	320-1100	9500	0.31	0.57	160
25PDU05MIL	T05/3	2.3 x 1.3	3.2	R70G	320-1100	950	0.31	0.57	96
11PS18MIL	T018/3	1.0 x 1.0	1.0	R70G	320-1100	950	0.31	0.57	30

1) MINIMUM RESPONSIVITY IS 90% OF TYPICAL RESPONSIVITY. 2) SHORT CIRCUIT CURRENT (I_{sc}) IS MEASURED WITH 10 mW/cm² OF OPTICAL POW

DARK CURRENT vs. VOLTAGE

CAPACITANCE vs. VOLTAGE

RESPONSIVITY CURVES (TYPICAL)

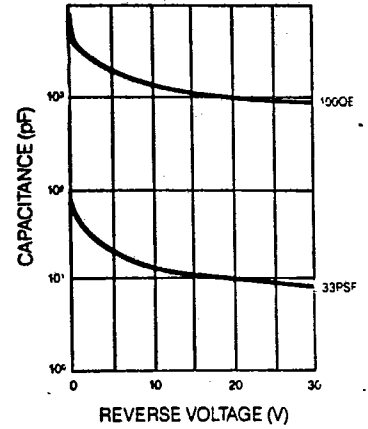
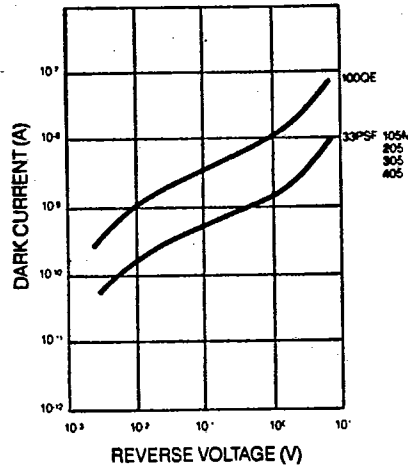
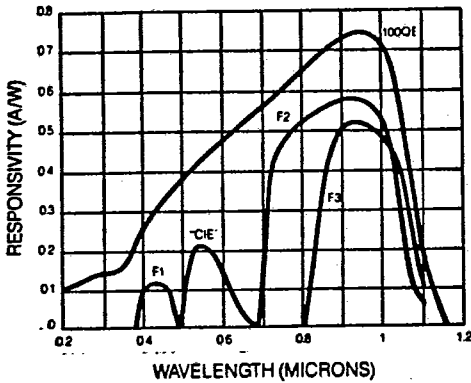

$V_R = -0.01V$ MAX. (nA)	DARK CURRENT			BREAKDOWN VOLT. $I_{DR} = 10\mu A$ MIN. (V)	SHUNT RESISTANCE TYP. (Mohm)	TYPICAL CAPACITANCE			RISETIME ²⁾		NEP TYP. ($W\sqrt{Hz}$)	D^* TYP. ($cm\sqrt{Hz}/W$)
	$V_R = -1.0V$ MAX. (nA)	$V_R = -10V$ MAX. (nA)	MIN.			$V_R = 0V$	$V_R = -1V$	$V_R = -10V$	$V_R = 0, V_R = -10V$ (ns)	$V_R = -10V$ (ns)		
0.33	6.0	14	50	60	114	55	19	450	3	1.6E-14	1.4E+13	
0.33	6.0	14	50	60	114	55	19	450	3	1.6E-14	1.4E+13	
0.33	6.0	14	50	60	114	55	19	450	3	1.6E-14	1.4E+13	
0.33	6.0	14	50	60	114	55	19	450	3	1.6E-14	1.4E+13	
20	100	5000	15	10	8800	4200	1500	2000	200	4.0E-14	1.4E+13	

2) 50 OHM LOAD $\lambda = 800\text{ nm}$

DARK CURRENT vs. VOLTAGE

CAPACITANCE vs. VOLTAGE

RESPONSIVITY CURVES (TYPICAL)

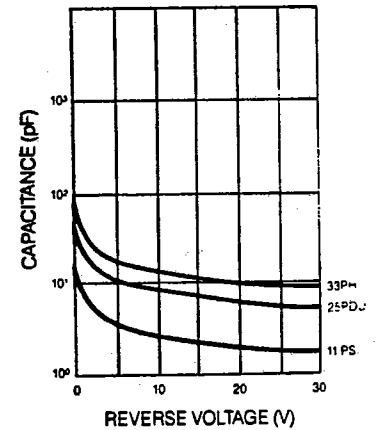
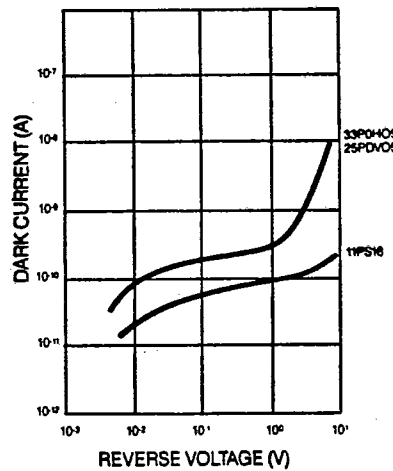
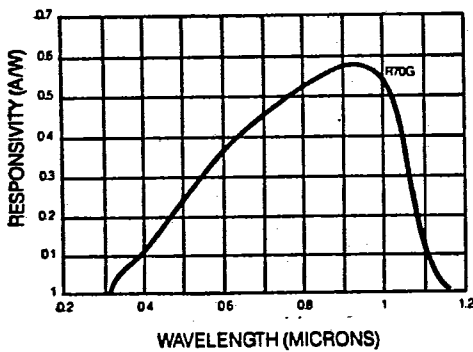

$V_R = -0.01V$ MAX. (nA)	DARK CURRENT			BREAKDOWN VOLT. $I_{DR} = 10\mu A$ MIN. (V)	SHUNT RESISTANCE TYP. (Mohm)	TYPICAL CAPACITANCE			RISETIME ³⁾		NEP TYP. ($W\sqrt{Hz}$)	D^* TYP. ($cm\sqrt{Hz}/W$)
	$V_R = -1.0V$ MAX. (nA)	$V_R = -10V$ MAX. (nA)	MIN.			$V_R = 0V$	$V_R = -1V$	$V_R = -10V$	$V_R = 0, V_R = -10V$ (ns)	$V_R = -10V$ (ns)		
0.20	0.50	25 ($V_R = -5V$)	50	100	125	56	19	450	3	1.3E-14	1.8E+13	
0.21			50	100	77	34	12	450	3	1.3E-14	1.4E+13	
0.2			100	400	24	11	4	450	2	6.3E-15	1.6E+13	

Calibration

Sunsensor and solar cell performance are critically dependent on short-circuit current values when illuminated by direct sunlight. For this reason, ADC offers a service for Air Mass Zero (AMO) calibration of detectors or solar cells.

Two services are offered: A calibration based on an actual balloon flight to a height of at least 115,000 feet to minimize atmospheric effects, or a high altitude mountain calibration with an atmospheric effect correction to AMO. Obviously, the balloon flight technique offers the highest accuracy ($\pm 2\%$ maximum error), but the balloon flight is only available annually. The terrestrial calibration is available with three-month delivery, weather permitting.

It is highly recommended that the calibration be performed using a detector which has an absolute spectral response which is typical of the devices which will make use of the calibration. Either an ADC detector or a customer detector can be used.

The calibrated detector is provided with a custom-designed housing, which protects the device when not in use and provides water connections for temperature control and a standard J-type thermocouple for temperature monitoring of the detector. Figure 2 is a photograph of a 2 cm x 4 cm calibrated detector mounted in our custom housing.

Opto-Hybrids

ADC produces opto-hybrids in single, dual, quadrant, and octal-element configurations. The standard configuration for the single, dual, and quadrant element opto-hybrids contains the detector and operational amplifier in a single housing with terminals available to connect the feedback resistor(s) as required. If desired, the resistors and capacitors can be placed internally to customer specifications. The standard configuration for the ADC octal configuration provides the resistive/capacitive network internally. As always, ADC will accommodate your design criteria.

RESPONSIVITY vs. FREQUENCY (TYPICAL) For Single, Dual and Quadrant Opto-Hybrids

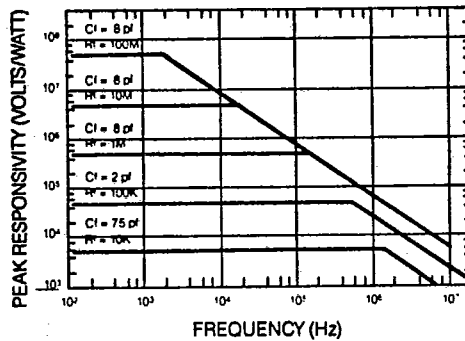

RESPONSIVITY vs. FREQUENCY (TYPICAL)

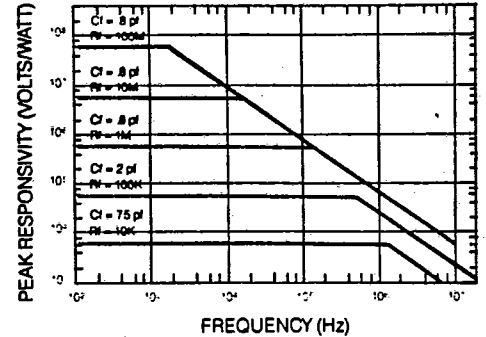

NEP vs. FREQUENCY (TYPICAL)

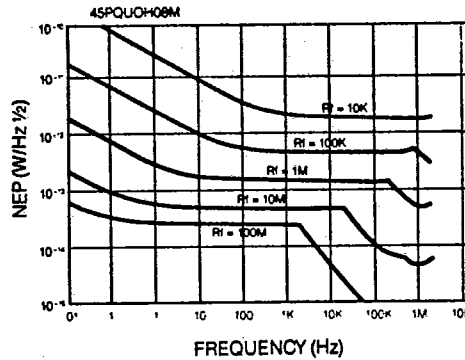

NEP vs. FREQUENCY (TYPICAL)

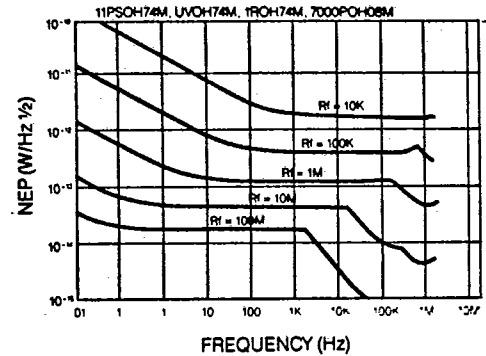

NEP vs. FREQUENCY (TYPICAL)

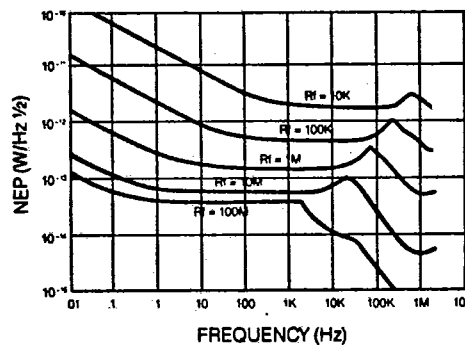

NEP vs. FREQUENCY (TYPICAL)

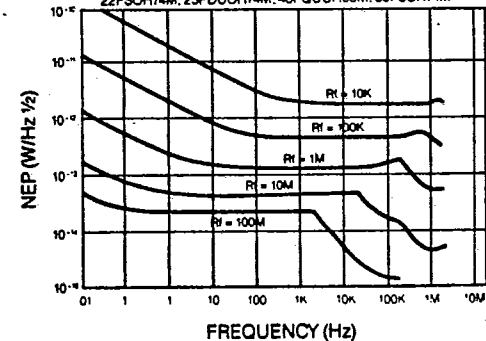

HYBRIDS

TYPE NUMBER	PACKAGE OUTLINE	No. OF ELEMENTS	ELEMENT DIMENSIONS (mm)	PITCH (mm)	PHOTO-SENSITIVE AREA (mm ²)	RESPONSE CURVE TYPE	RANGE (nm)	PEAK WAVE-LENGTH (nm)	RESPONSIVITY ¹⁾		
									254 nm (V/W)	550 nm (V/W)	PEAK (V/W)
11PSOH74M	T074	1	1.02 x 1.02	—	1.0	R70G	320-1100	950	—	3.1E+075.8E+07	—
22PSOH74M	T074	1	1.52 x 1.52	—	2.3	R70G	320-1100	950	—	3.1E+075.8E+07	—
33PSOH74M	T074	1	2.29 x 2.29	—	5.2	R70G	320-1100	950	—	3.1E+075.8E+07	—
44PSOH74M	T074	1	4.17 x 4.17	—	17	R70G	320-1100	950	—	3.1E+075.8E+07	—
AD1010H74M	T074	1	2.14 DIAM.	—	3.6	AD101G	320-1060	875	—	2.7E+075.0E+07	—
UVOH74M1R	T074	1	2.14 Dia.	—	3.6	UVQ	320-1100	950	> 9E	062.8E+074.8E+07	—
25PDUOH74M	T074	2	2.5 x 1.3	1.43	3.2	R70G	320-1100	950	—	3.1E+075.8E+07	—
45PQUOH08	T08/12	2x2	1.3 x 1.3	1.43	1.7	R70G	320-1100	950	—	3.1E+075.8E+07	—
7000POH08M	T08/16	2x4	2.3 x 1.3	2.8 x 1.6	2.9	R100G	320-1100	950	—	3.1E+075.9E+07	—

¹⁾ MINIMUM RESPONSIVITY IS 90% OF TYPICAL RESPONSIVITY.

RESPONSIVITY CURVES (TYPICAL)

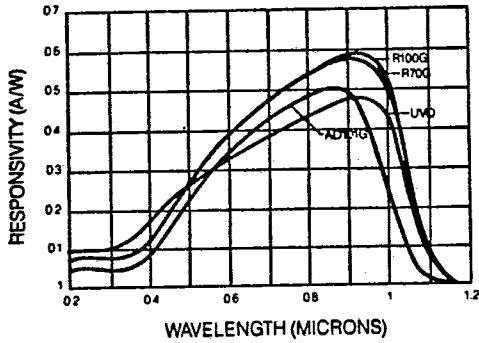

CONNECTION DIAGRAM FOR 7000POH08M

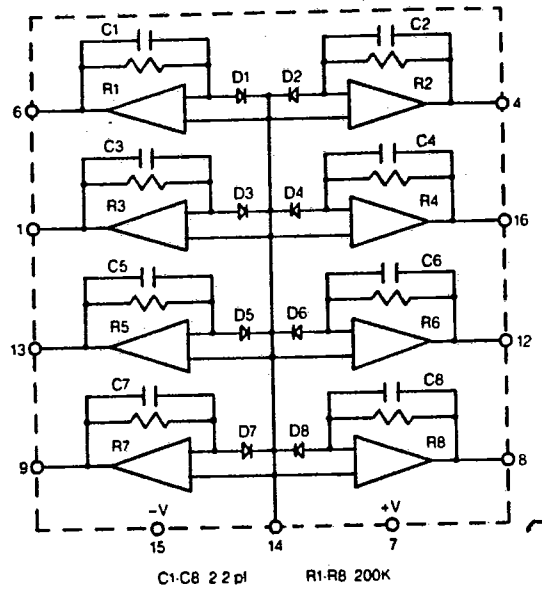

CONNECTION DIAGRAM FOR 25PDU0H74M

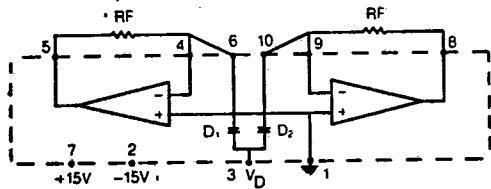

CONNECTION DIAGRAM FOR SINGLE ELEMENT OPTO-HYBRIDS

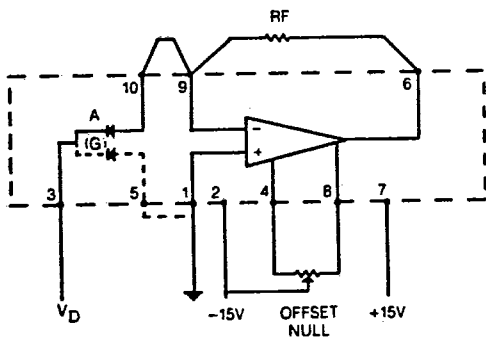

CONNECTION DIAGRAM FOR 45QUH08M

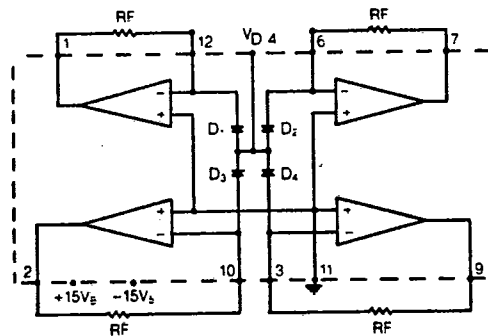

DARK CURRENT		BREAKDOWN VOLT.	SHUNT RESISTANCE	TYPICAL CAPACITANCE		RISE TIME ²⁾	NEP ³⁾	D*	VOLTAGE		CURRENT
$V_A = -0.01V$	$V_A = -10V^3$	$I_{br} = 10\mu A$	TYP.	$V_R = 0V$	$V_R = -10V$	$V_R = -10V$	TYP.	TYP.	MIN.	MAX.	(mA)
MAX. (nA)	MAX. (nA)	MIN. (V)	(Mohm)	(pF)	(pF)	(ns)	($W\sqrt{Hz}$)	($cm\sqrt{Hz/W}$)	(+/-)	(+/-)	
0.10	2	75	200	22	4	300	$1.8E-14$	$5E+12$	5	18	4.5
0.20	5	70	100	50	.9	310	$2.2E-14$	$6E+12$	5	18	4.5
0.33	14	50	100	110	19	410	$5.1E-14$	$4E+12$	5	18	4.5
0.67	36	20	50	370	64	630	$3.5E-14$	$1E+12$	5	18	4.5
0.10	30	100	200	75	13	300	$2.4E-14$	$8E+12$	5	18	4.5
0.04	1	20	300	79	13	300	$1.5E-14$	$1E+12$	5	18	4.5
0.23	1	10	50	70	12	310	$2.7E-14$	$6E+12$	5	18	9
0.24	1	10	100	37	6	310	$2.2E-14$	$6E+12$	5	18	18
0			200	17	3	900 ($V_R = 0V$)	$1.8E-14$	$9E+12$	12	22	15

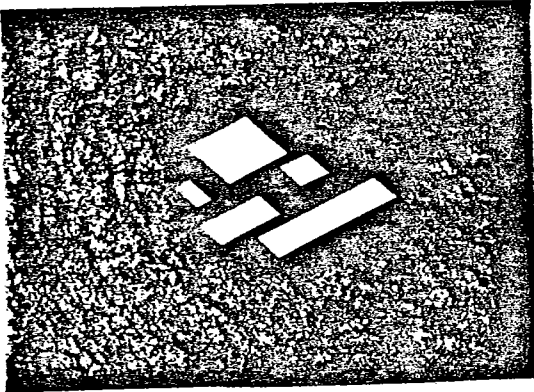

STANDARD PLANAR & SOLDERABLE CHIPS

TYPE NUMBER	CHIP DIMENSIONS (mm)	PHOTO-SENSITIVE AREA (mm ²)	RESPONSE CURVE TYPE	RESPONSE RANGE (nm)	PEAK WAVE-LENGTH (nm)	RESPONSIVITY ¹⁾		PEAK (A/W)	Isc ²⁾ (mA)
						254 nm (A/W)	550 nm (A/W)		
BLUE AND VISIBLE RESPONSE									
58PBH	5.0 x 2.2	9	B70	200-1100	950	> .06	0.37	0.59	0.3
58PBHL	5.0 x 2.2	9	B70	200-1100	950	> .06	0.37	0.59	0.3
55PBH	5.0 x 4.8	21	B70	200-1100	950	> .06	0.37	0.59	0.7
55PBHL	5.0 x 4.8	21	B70	200-1100	950	> .06	0.37	0.59	0.7
51PBH	5.0 x 9.9	43	B70	200-1100	950	> .06	0.37	0.59	1.4
51PBHL	5.0 x 9.9	43	B70	200-1100	950	> .06	0.37	0.59	1.4
52PBH	5.0 x 2.0	87	B70	200-1100	950	> .06	0.37	0.59	2.8
52PBHL	5.0 x 2.0	87	B70	200-1100	950	> .06	0.37	0.59	2.8
110PBH	1.0 x 1.0	93	B70	200-1100	950	> .06	0.37	0.59	3.0
110PBHL	10.0 x 10.0	93	B70	200-1100	950	> .06	0.37	0.59	3.0
NEAR IR RESPONSE									
58PH	5.0 x 2.2	9	R70	200-1100	950	> .05	0.34	0.63	0.3
58PHL	5.0 x 2.2	9	R70	200-1100	950	> .05	0.34	0.63	0.3
55PH	5.0 x 4.8	21	R70	200-1100	950	> .05	0.34	0.63	0.7
55PHL	5.0 x 4.8	21	R70	200-1100	950	> .05	0.34	0.63	0.7
51PH	5.0 x 9.9	43	R70	200-1100	950	> .05	0.34	0.63	1.4
51PHL	5.0 x 9.9	43	R70	200-1100	950	> .05	0.34	0.63	1.4
52PH	5.0 x 2.0	87	R70	200-1100	950	> .05	0.34	0.63	2.9
52PHL	5.0 x 2.0	87	R70	200-1100	950	> .05	0.34	0.63	2.9
110PH	1.0 x 1.0	93	R70	200-1100	950	> .05	0.34	0.63	3.1
110PHL	10.0 x 10.0	93	R70	200-1100	950	> .05	0.34	0.63	3.1

¹⁾ MINIMUM RESPONSIVITY IS 90% OF TYPICAL RESPONSIVITY. ²⁾ SHORT CIRCUIT CURRENT (Isc) IS MEASURED WITH 10 mW/cm² OF OPTICAL PO

RESPONSIVITY CURVES (TYPICAL)

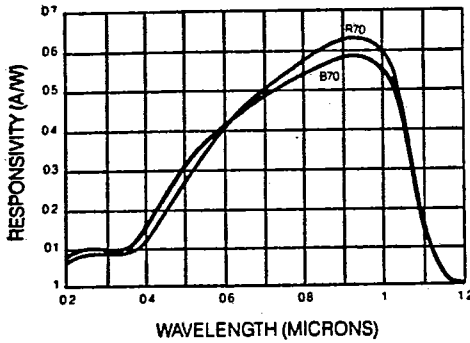

DARK CURRENT vs. VOLTAGE

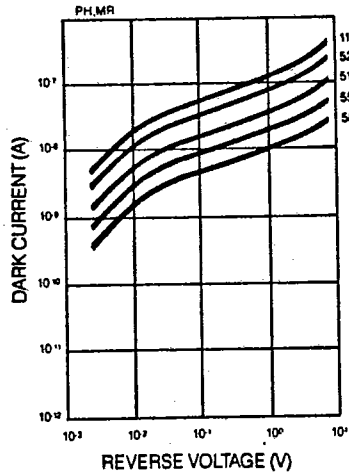

CAPACITANCE vs. VOLTAGE

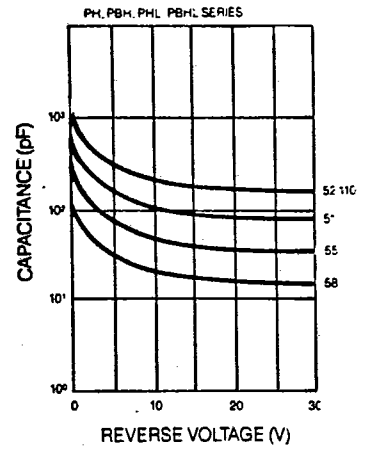

ELECTRICAL PARAMETERS **PHYSICAL PERFORMANCE**

Part No.	DARK CURRENT			BREAKDOWN VOLT. $I_{DR} = 10 \mu A$ MIN. (V)	SHUNT RESISTANCE TYP. (Mohm)	TYPICAL CAPACITANCE			RISETIME ³⁾		NEP TYP. ($W \sqrt{Hz}$)	D* TYP. ($cm \sqrt{Hz/W}$)
	$V_R = -0.01V$ MAX. (nA)	$V_R = -1.0V$ MAX. (nA)	$V_R = -10V^{(4)}$ MAX. (nA)			$V_R = 0V$ (pF)	$V_R = -1V$ (pF)	$V_R = -10V$ (pF)	$V_R = 0$ (ns)	$V_R = -10V$ (ns)		
1	10	20	15	10	200	95	34	450	5	4.0E-14	7.5E+12	
6	60	120	10	5	200	95	34	450	5	5.7E-14	5.3E+12	
3	25	50	10	3	460	221	79	450	10	7.3E-14	6.3E+12	
12	120	250	6	2	460	220	79	450	10	8.9E-14	5.1E+12	
5	50	100	8	2	940	450	161	500	20	8.9E-14	7.3E+12	
30	300	600	5	1	940	450	161	500	20	1.3E-13	5.2E+12	
9	90	200	6	1	1900	916	325	525	40	1.3E-13	7.4E+12	
50	500	1000	3	0.5	1900	916	325	525	40	1.8E-13	5.2E+12	
10	100	200	5	1	2040	979	348	500	45	1.3E-13	7.6E+12	
60	600	1200	2	0.5	2040	979	348	500	45	1.8E-13	5.4E+12	

2	15	30	12	5	197	95	34	450	5	5.7E-14	5.3E+12
6	60	120	12	2	197	95	34	450	5	8.9E-14	3.4E+12
3	30	60	8	3	460	221	79	450	10	7.3E-14	6.3E+12
12	120	250	8	1	460	221	79	450	10	1.3E-13	3.6E+12
7	75	150	6	0.2	942	453	161	500	20	2.8E-13	2.3E+12
30	300	600	6	0.3	942	453	161	500	20	2.3E-13	2.8E+12
12	125	250	4	1	1906	916	325	525	40	1.3E-13	7.4E+12
50	500	1000	4	7.2	1906	916	325	525	40	4.7E-14	2.0E+13
20			3	0.5	2038	979	348	500	45	1.8E-13	5.4E+12
			3	0.5	2038	979	348	500	45	2.8E-13	3.4E+12

STANDARD SOLDERABLE CHIPS

TYPE NUMBER	CHIP DIMENSIONS (mm)	PHOTO-SENSITIVE AREA (mm ²)	RESPONSE CURVE TYPE	RESPONSE RANGE (nm)	PEAK WAVELENGTH (nm)	RESPONSIVITY ¹⁾			Isc ²⁾ (mA)
						254 nm (A/W)	550 nm (A/W)	PEAK (A/W)	
BLUE AND VISIBLE RESPONSE (MESA)									
58MB	5.0 x 2.2	9	MB	250-1060	900	> .04	0.38	0.58	0.3
58MBL	5.0 x 2.2	9	MB	250-1060	900	> .04	0.38	0.58	0.3
55MB	5.0 x 4.8	21	MB	250-1060	900	> .04	0.38	0.58	0.7
55MBL	5.0 x 4.8	21	MB	250-1060	900	> .04	0.38	0.58	0.7
51MB	5.0 x 9.9	43	MB	250-1060	900	> .04	0.38	0.58	1.4
51MBL	5.0 x 9.9	43	MB	250-1060	900	> .04	0.38	0.58	1.4
52MB	5.0 x 2.0	87	MB	250-1060	900	> .04	0.38	0.58	2.9
52MBL	5.0 x 2.0	87	MB	250-1060	900	> .04	0.38	0.58	2.9
110MB	10.0 x 10.0	93	MB	250-1060	900	> .04	0.38	0.58	3.1
110MBL	10.0 x 10.0	93	MB	250-1060	900	> .04	0.38	0.58	3.1
HIGH SHORT CIRCUIT CURRENT (MESA)									
58MR	5.0 x 2.2	9	MR	250-1060	900	> .04	0.33	0.65	3.2
58MRL	5.0 x 2.2	9	MR	250-1060	900	> .04	0.33	0.65	3.2
55MR	5.0 x 4.8	21	MR	250-1060	900	> .04	0.33	0.65	7.4
55MRL	5.0 x 4.8	21	MR	250-1060	900	> .04	0.33	0.65	7.4
51MR	5.0 x 9.9	43	MR	250-1060	900	> .04	0.33	0.65	15.0
51MRL	5.0 x 9.9	43	MR	250-1060	900	> .04	0.33	0.65	15.0
52MR	5.0 x 2.0	87	MR	250-1060	900	> .04	0.33	0.65	30.5
52MRL	5.0 x 2.0	87	MR	250-1060	900	> .04	0.33	0.65	30.5
110MR	10.0 x 10.0	93	MR	250-1060	900	> .04	0.33	0.65	32.6
110MRL	10.0 x 10.0	93	MR	250-1060	900	> .04	0.33	0.65	32.6
LOW COST GENERAL PURPOSE									
58PV	5.0 x 2.2	9	PV	250-1050	900	> .03	0.24	0.46	0.2
58PVL	5.0 x 2.2	9	PV	250-1050	900	> .03	0.24	0.46	0.2
55PV	5.0 x 4.8	21	PV	250-1050	900	> .03	0.24	0.46	0.5
55PVL	5.0 x 4.8	21	PV	250-1050	900	> .03	0.24	0.46	0.5
51PV	5.0 x 9.9	43	PV	250-1050	900	> .03	0.24	0.46	1.1
51PVL	5.0 x 9.9	43	PV	250-1050	900	> .03	0.24	0.46	1.1
52PV	5.0 x 2.0	87	PV	250-1050	900	> .03	0.24	0.46	2.2
52PVL	5.0 x 2.0	87	PV	250-1050	900	> .03	0.24	0.46	2.2
110PV	10.0 x 10.0	93	PV	250-1050	900	> .03	0.24	0.46	2.3
110PVL	10.0 x 10.0	93	PV	250-1050	900	> .03	0.24	0.46	2.3



¹⁾ SHORT CIRCUIT CURRENT (I_{sc}) IS MEASURED WITH 10 mW/cm² OF OPTICAL POWER

DARK CURRENT vs. VOLTAGE

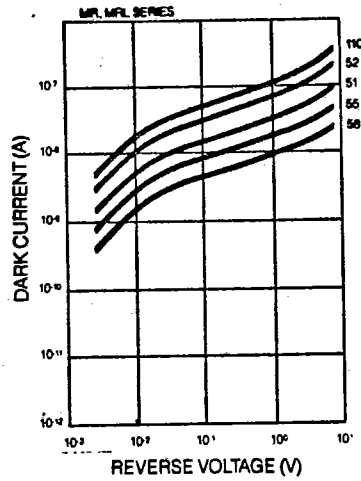

CAPACITANCE vs. VOLTAGE

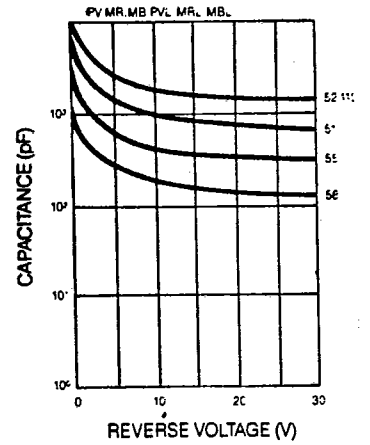

RESPONSIVITY CURVES (TYPICAL)

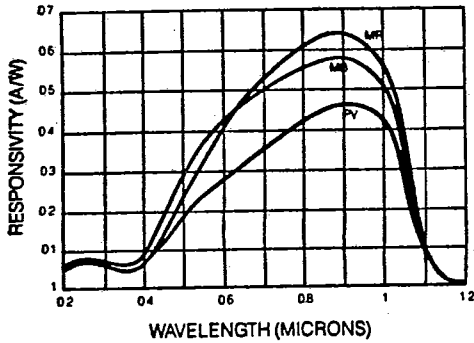

Part No.	DARK CURRENT			BREAKDOWN VOLT. I _{DR} = 10 μA MIN. (V)	SHUNT RESISTANCE TYP. (Mohm)	TYPICAL CAPACITANCE			RISETIME ³⁾		NEP TYP. (W√Hz)	D* TYP. (cm√Hz/W)
	V _R = -0.01V MAX. (nA)	V _R = -1.0V MAX. (nA)	V _R = -10V ⁴⁾ MAX. (nA)			V _R = 0V (pF)	V _R = -1V (pF)	V _R = -10V (pF)	V _R = 0, (ns)	V _R = -10 V (ns)		
1	10	20	15	10	1150	600	210	650	500	4.0E-14	7.5E+12	
6	60	120	10	5	1150	600	210	650	500	5.7E-14	5.3E+12	
3	25	50	10	3	2700	1370	500	750	500	7.3E-14	6.3E+12	
12	120	250	6	2	2700	1370	500	750	500	8.9E-14	5.1E+12	
5	50	100	8	2	5500	2800	1000	900	500	8.9E-14	7.3E+12	
30	300	600	5	1	5500	2800	1000	900	500	1.3E-13	5.2E+12	
9	90	200	6	1	11000	5700	2050	1500	600	1.3E-13	7.4E+12	
50	500	1000	3	0.5	11000	5700	2050	1500	600	1.8E-13	5.2E+12	
10	100	200	5	1	12000	6100	2200	1500	600	1.3E-13	7.6E+12	
60	600	1200	2	0.5	12000	6100	2200	1500	600	1.8E-13	5.4E+12	
2	15	30	14	5	1150	600	210	650	500	5.7E-14	5.3E+12	
6	60	120	12	2	1150	600	210	650	500	8.9E-14	3.4E+12	
3	30	60	10	3	2700	1400	500	750	500	7.3E-14	6.3E+12	
12	120	250	8	1	2700	1400	500	750	500	1.3E-13	3.6E+12	
7	75	150	8	0.3	5500	2800	1000	900	500	2.8E-13	2.3E+12	
30	300	600	7	0.2	5500	2800	1000	900	500	2.3E-13	2.8E+12	
12	125	250	6	1	11000	5700	2050	1500	600	1.3E-13	7.4E+12	
50	500	1000	5	0.5	11000	5700	2050	1500	600	4.7E-14	2.0E+12	
20	200	400	5	0.5	12000	6100	2200	1500	600	1.8E-13	5.4E+12	
60	400	1200	4	0.2	12000	6100	2200	1500	600	2.8E-13	3.4E+12	
6	60	120	12	2	1150	600	210	650	500	8.9E-14	3.4E+12	
10	80	120	10	1	1150	600	210	650	500	1.3E-13	2.4E+12	
12	120	250	8	1	2700	1400	500	750	500	1.3E-13	3.6E+12	
15	150	250	7	1	2700	1400	500	750	500	1.3E-13	3.6E+12	
30	300	600	7	0.3	5500	2800	1000	900	500	2.3E-13	2.8E+12	
40	400	600	6	0.2	5500	2800	1000	900	500	2.8E-13	2.3E+12	
50	500	1000	5	7.2	11000	5700	2050	1500	600	4.7E-14	2.0E+12	
60	600	1000	4	0.2	11000	5700	2050	1500	600	2.8E-13	3.3E+12	
60	600	1200	4	0.2	12000	6100	2200	1500	600	2.8E-13	3.4E+12	
70	500	1200	3	0.2	12000	6100	2200	1500	600	2.8E-13	3.4E+12	

Detector Arrays and Long-Line Strip Detectors

ADC offers silicon multi-element linear and matrix arrays with excellent blue response and element matching. Our custom manufacturing capabilities allow us to provide photodiode arrays with the element shape, uniformity, crosstalk, and inter-element spacing optimized for the application.

Long-line incorporate state-of-the-art linearity, uniformity, and stability performance. Typical packaging consists of five to twenty one-inch photodiodes mounted in series with a typical inter-element gap of 0.002 inch on a common PCB substrate. The subassembly is then mounted on a customer-specified metal housing to facilitate installation into the main frame. The length and cell count can, of course, be customized beyond our current production devices, typically for use in facsimile applications.

RESPONSIVITY CURVES (TYPICAL)

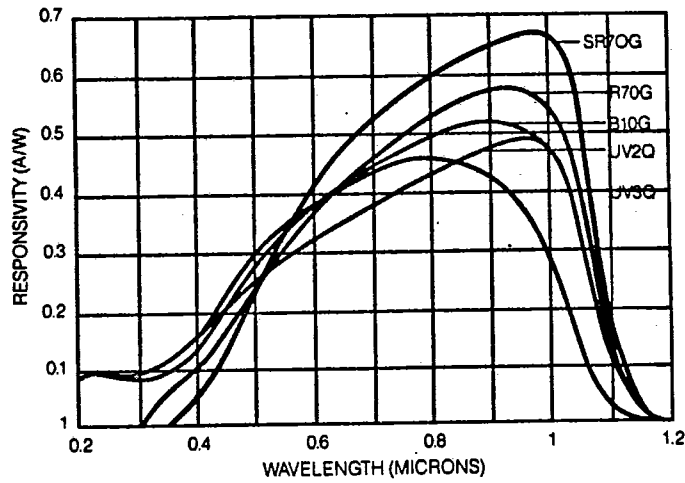

ARRAYS

TYPE NUMBER	PHYSICAL PARAMETERS					OPTICAL PARAMETERS					
	PACKAGE OUTLINE	No. OF ELEMENTS	ELEMENT DIMENSIONS (mm)	PITCH (mm)	PHOTO-SENSITIVE AREA (mm ²)	RESPONSE CURVE TYPE	RESPONSE RANGE (nm)	PEAK WAVELENGTH (nm)	RESPONSIVITY ¹⁾ 254 nm (A/W)	550 nm (A/W)	PEAK (A/W)
ADC8019	C5	72	.28 x 6.35	0.31	1.8	B10G	320-1060	900	—	0.34	0.52
ADC8020	C7	14	.56 x .51	0.86	0.29	B10G	320-1060	900	—	0.34	0.52
ADC1000	C9	8	1.3 x 1.6	1.59	21	B10G	320-1060	900	—	0.34	0.52
ADC2000	C10	16	1.2 x 2	1.58	2.4	B10G	320-1060	900	—	0.34	0.52
ADC3000	C11	16	2.0 x 4.5	2.54	5.2	B10G	320-1060	900	—	0.34	0.52
ADC4000	C6	32	.51 x 5.9	0.63	3.0	B10G	320-1060	900	—	0.34	0.52
ADC4050	C12	3 x 5	2.0 x 1.0	2.41	2.1	B10G	320-1060	900	—	0.34	0.57
ADC5000	C8	10†	25.4 x 9.9	25.6	2340	SR70G	370-1100	950	—	0.34†	0.57
ADC6000	C8	10†	25 x 2.8	25.4	654	SR70G	370-1100	950	—	0.34†	0.57
ADC7000	C8	10†	23 x 4.7	25.4	1110	SR70G	370-1100	950	—	0.34†	0.57
45PQU05M	T05/5	2 x 2	1.3 x 1.3	1.43	1.7	R70G	320-1100	950	—	0.31	0.57
25PDU05M	T05/3	2	1.3 x 2.5	1.43	3.2	R70G	320-1100	950	—	0.31	0.57
ADC8001	C13	35	.9 x 4.4	1	3.96	UVQ	200-1100	900	0.09	0.30	0.47
ADC8002	C13	35	.9 x 4.4	1	3.96	UVQ	200-1000	750	0.09	0.36	0.47
ADC8003	C13	35	.9 x 4.4	1	3.96	UVQ	200-1100	900	0.09	0.27	0.51
ADC8004	C13	35	.9 x 4.4	1	3.96	UVQ	200-1000	750	0.09	0.36	0.47
ADC8005	C6	35	.9 x 4.5	0.99	4.05	UVQ	200-1100	900	0.09	0.28	0.52
ADC8006	C6	35	.9 x 4.5	0.99	4.05	UVQ	200-1100	900	0.09	0.28	0.52
ADC8007	C6	35	.9 x 4.5	0.99	4.05	UVQ	200-1100	900	0.09	0.28	0.52
ADC8008	C6	35	.9 x 4.5	0.99	4.05	UVQ	200-1100	900	0.09	0.28	0.52
ADC8009	C6	35	.9 x 4.5	0.99	4.05	UVQ	200-1100	900	0.09	0.28	0.52
ADC8010	C6	35	.9 x 4.5	0.99	4.05	UVQ	200-1100	900	0.09	0.28	0.52
ADC8011	C13	38	.9 x 4.4	1	3.96	UVQ	200-1100	900	0.09	0.28	0.52
ADC8012	C13	38	.9 x 4.4	1	3.96	UVQ	200-1000	750	0.09	0.36	0.47
ADC8013	C13	38	.9 x 4.4	1	3.96	UVQ	200-1100	900	0.09	0.28	0.52
ADC8014	C13	38	.9 x 4.4	1	3.96	UVQ	200-1000	750	0.09	0.36	0.47
ADC8015	C5	38	.9 x 4.4	1	3.96	UVQ	200-1100	900	0.09	0.28	0.52
ADC8016	C5	46	.9 x 4.4	1	3.96	UVQ	200-1000	750	0.09	0.36	0.47
ADC8017	C5	46	.9 x 4.4	1	3.96	UVQ	200-1100	900	0.09	0.28	0.52
ADC8018	C5	46	.9 x 4.4	1	3.96	UVQ	200-1000	750	0.09	0.36	0.47

†CONNECTED IN PARALLEL

¹⁾ MINIMUM RESPONSIVITY IS 90% OF TYPICAL RESPONSIVITY.



DARK CURRENT vs. VOLTAGE

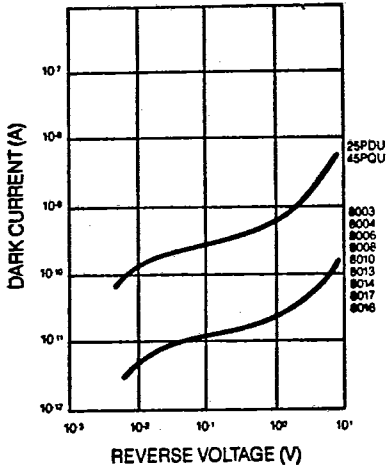

DARK CURRENT vs. VOLTAGE

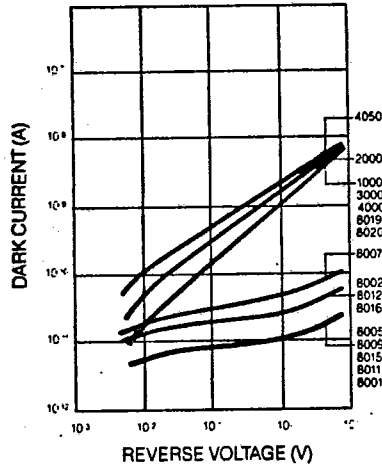

CAPACITANCE vs. VOLTAGE

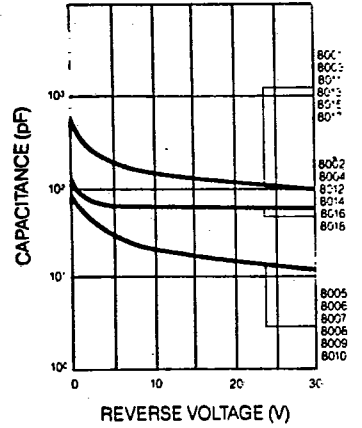

DARK CURRENTS				BREAKDOWN VOLT.	SHUNT RESISTANCE	TYPICAL CAPACITANCE			ADDITIONAL PERFORMANCE					
$V_R = -0.01V$	$V_R = -1.0V$	$V_R = -10V^3$		$I_{DR} = 10\mu A$	TYP.	$V_R = 0V$	$V_R = -1V$	$V_R = -10V$	RISETIME ²⁾	NEP	D*			
MAX.	MAX.	MAX.		MIN.	(Mohm)	(pF)	(pF)	(pF)	$V_R = 0,$	$V_R = -10V$	TYP.	TYP.		
(nA)	(nA)	(nA)		(V)					(ns)	(ns)	($W\sqrt{Hz}$)	($cm\sqrt{Hz^{-1}}$)		
0.05	6	40		5	400	190	180	130	500	5	6.3E-15	2.1E+13		
0.10	6	40		20	200	31	29	22	450	5	8.9E-15	6.0E+12		
0.10	6	40		40	200	220	210	160	500	5	8.9E-15	1.6E+13		
0.20	6	40		40	100	250	240	180	550	8	1.3E-14	1.2E+13		
0.05	6	40		40	400	550	520	390	600	10	6.3E-15	3.6E+13		
0.10	6	40		10	200	320	300	220	550	8	8.9E-15	1.9E+13		
0.38	6	40		40	53	220	210	100	500	5	1.7E-14	8.4E+12		
-	-	9,500 $V_R = -2.5V$		40	> 1	-	-	22,000 $V_R = -2.5V$	-	25,000 $V_R = -2.5V$	8.9E-14	5.4E+13		
-	-	20,000		40	> 1	-	-	4,000	-	5000	8.9E-14	2.9E+13		
-	-	20,000		40	> 1	-	-	4,000	-	5000	8.9E-14	3.7E+13		
0.23	1.0	10		50	90	1	1	1	450	5	1.4E-14	9.6E+12		
0.34	1.0	10		100	60	1	1	1	450	5	1.6E-14	1.1E+13		
0.01	.02	.05		40	2000	550	400	140	500	5	2.8E-15	7.0E+13		
0.01	0.02	0.05		40	2000	550	400	140	450	3	2.8E-15	7.0E+13		
0.01	0.2	.5		25	2000	550	400	140	500	5	2.8E-15	7.0E+13		
0.01	0.2	0.5		25	2000	550	400	140	450	3	2.8E-15	7.0E+13		
0.01	.02	.06		40	2000	550	400	140	450	5	2.8E-15	7.1E+13		
0.01	.05	.5		25	2000	550	400	140	450	5	2.8E-15	7.1E+13		
0.03	.10	.3		25	670	600	450	160	450	5	4.9E-15	4.1E+13		
0.03	0.3	.6		12	670	600	450	160	450	5	4.9E-15	4.1E+13		
0.01	.02	.06		40	2000	550	450	160	450	5	2.8E-15	7.1E+13		
0.01	.02	.5		12	2000	550	400	140	450	5	2.8E-15	7.1E+13		
0.01	.02	.05		40	2000	550	400	140	500	5	2.8E-15	7.0E+13		
0.01	0.02	0.05		40	2000	550	400	140	450	3	2.8E-15	7.0E+13		
0.01	0.2	.5		25	2000	550	400	140	500	5	2.8E-15	7.0E+13		
0.01	0.2	0.5		25	2000	550	400	140	450	3	2.8E-15	7.0E+13		
0.01	0.02	.05		40	2000	550	400	140	500	5	2.8E-15	7.0E+13		
0.01	0.2	.5		25	2000	550	400	140	450	3	2.8E-15	7.0E+13		
0.01	0.02	.05		40	2000	550	400	140	500	5	2.8E-15	7.0E+13		
0.0				25	2000	550	400	140	500	5	2.8E-15	7.0E+13		
0.0				25	2000	550	400	140	450	3	2.8E-15	7.0E+13		

Position Sensors

ADC has both lateral effect cells and segmented detectors. These devices are used to measure angle and displacement, optical alignment, and laser positioning.

Lateral effect cells are offered in single-axis and dual-axis configurations providing extremely accurate position measurement over a large area with a wide dynamic range. Accuracy and responsivity are not affected by the size, shape, or position of the light as long as the image remains in the active area of the detector.

Segmented detectors include both dual and quad-element photodiodes. These devices are designed for laser positioning and other null applications which require detection of the relative position of a light spot.

Both position sensor types offer a high degree of position sensitivity and accuracy over a wide incident power range. There are two standard configurations, but, as with all ADC products, custom device design and fabrication is available.

Applications

- Construction Laser Instrumentation
- Process Control Instrumentation
- Machine Tool Alignment
- Laser Positioning Sensing
- Computer Peripherals
- Photocopiers
- Mask Aligners
- Optical Sound-Track Systems
- Vibration Analysis
- Robotic Eyes

Ultra-Low Capacitance Photodiodes

When extremely low light levels are measured by photodiodes, the capacitance of the detector often deteriorates the system's signal-to-noise ratio because of its influence on the frequency response of the first stage of amplification. The standard approaches of using higher resistivity, reverse biasing or smaller detectors is not acceptable in many applications which demand a large-area detector.

To meet this new demand, ADC has developed and patented a unique photodiode structure which offers much improved shunt resistance and lower capacitance over conventional approaches. This product line has exceptionally large detectivity (D.), and

most expensive standard photodiodes at a fraction of the cost. Capacitances as low as 8 pf, combined with shunt resistances of over 1,000 megohms, can be specified for a 0.2 cm² device. The data table describes two standard devices. Custom geometries and packages are readily available.

Low Cost (Plastic) Packages

The 1RPE, 11BHPE, and 22PHPE planar silicon photodiodes are available in a clear plastic package. This low-cost, high-performance approach allows arrays up to six elements long in a 16-pin, dual-in-line configuration. These packages can be easily soldered to printed circuit boards or socketed.

RESPONSIVITY CURVES (TYPICAL)

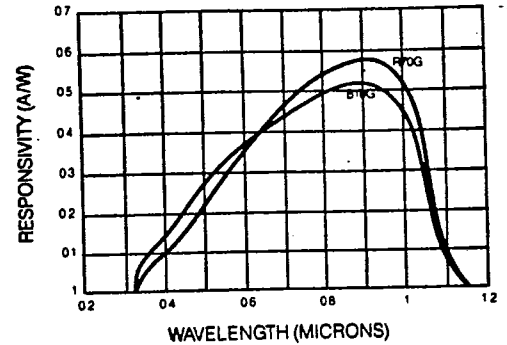

POSITION SENSORS

TYPE NUMBER	PACKAGE OUTLINE	NO. OF ELEMENTS	ELEMENT DIMENSIONS (mm)	PHOTO-SENSITIVE AREA (mm ²)	RESPONSE CURVE TYPE	PEAK WAVE-LENGTH (nm)	RESPONSIVITY ¹⁾			Isc (mA)	
							254 nm (A/W)	550 nm (A/W)	PEAK (A/W)		
110PS1D	C14	1	13 x 13	169	B10G	320-1060	900	—	0.34	0.52	—
110PS2D	C15	1	13 x 13	169	B10G	320-1060	900	—	0.34	0.52	—
45PQU05M	T05/5	2 x 2	1.3 x 1.3	1.7	R70G	320-1100	950	—	0.31	0.57	—
25PDU05M	T05/3	2	2.5 x 1.3	3.3	R70G	320-1100	950	—	0.31	0.57	—

¹⁾ MINIMUM RESPONSIVITY IS 90% OF TYPICAL RESPONSIVITY.

ULTRA LOW CAPACITANCE

TYPE NUMBER	PACKAGE OUTLINE	ELEMENT DIMENSION (mm)	PHOTO-SENSITIVE AREA (mm ²)	RESPONSE CURVE TYPE	RESPONSE RANGE (nm)	PEAK WAVE-LENGTH (nm)	RESPONSIVITY ¹⁾			Isc ²⁾ (mA)
							254 nm (A/W)	550 nm (A/W)	PEAK (A/W)	
ULC240	C1	80	80	ULC	200-1100	>950	.06	0.35	0.57	2.4
ULC230	C2	61	61	ULC	200-1100	>950	.06	0.35	0.57	1.83

¹⁾ MINIMUM RESPONSIVITY IS 90% OF TYPICAL RESPONSIVITY. ²⁾ SHORT CIRCUIT CURRENT (Isc) IS MEASURED WITH 10 mW/cm² OF OPTICAL POW FROM A TUNGSTEN LIGHT SOURCE OPERATED AT 2800 degK TEMPERATURE.

LOW COST

TYPE NUMBER	PACKAGE OUTLINE	ELEMENT DIMENSION (mm)	PHOTO-SENSITIVE AREA (mm ²)	RESPONSE CURVE TYPE	RESPONSE RANGE (nm)	PEAK WAVE-LENGTH (nm)	RESPONSIVITY ¹⁾			Isc ²⁾ (mA)
							254 nm (A/W)	550 nm (A/W)	PEAK (A/W)	
1RPE	PDIP1	1.0 Diam.	0.79	AD101P	350-1060	875	—	0.27	0.40	24
1RPE6	PDIP2	1.0 Diam.	0.79	AD101P	350-1060	875	—	0.27	0.40	24
118HPE	PDIP1	1.0 x 1.0	1.03	B70P	350-1100	950	—	0.34	0.54	31
118HPE6	PDIP2	1.0 x 1.0	1.03	B70P	350-1100	950	—	0.34	0.54	31
22BHPE	PDIP1	1.5 x 1.5	2.3	B70P	350-1100	950	—	0.34	0.54	69
22BHPE6	PDIP2	1.5 x 1.5	2.3	B70P	350-1100	950	—	0.34	0.54	69

¹⁾ MINIMUM RESPONSIVITY IS 90% OF TYPICAL RESPONSIVITY. ²⁾ SHORT CIRCUIT CURRENT (Isc) IS MEASURED WITH 10 mW/cm² OF OPTICAL POW

DARK CURRENT vs. VOLTAGE

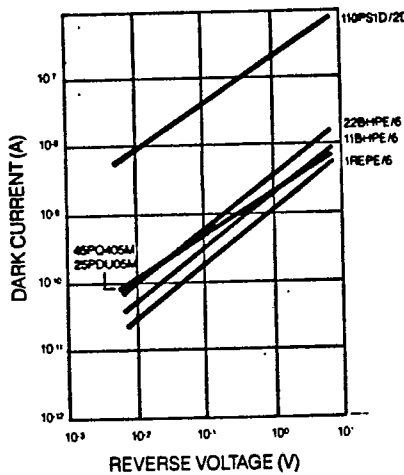

CAPACITANCE vs. VOLTAGE

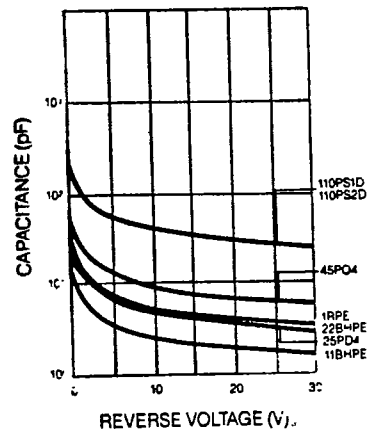

RESPONSIVITY CURVES (TYPICAL)

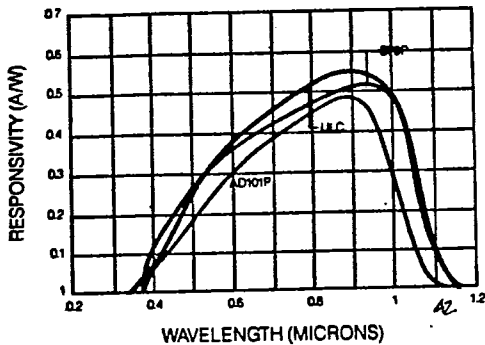

$V_R = -0.01V$ MAX. (nA)	DARK CURRENT		BREAKDOWN VOLT. $I_{DR} = 10\mu A$ MIN. (V)	SHUNT RESISTANCE TYP. (Mohm)	TYPICAL CAPACITANCE			RISETIME ³⁾		NEP TYP. ($W\sqrt{Hz}$)	D* TYP. ($cm\sqrt{Hz}/W$)
	$V_R = -1.0V$ MAX. (nA)	$V_R = -10V$ MAX. (nA)			$V_R = 0V$ (pF)	$V_R = -1V$ (pF)	$V_R = -10V$ (pF)	$V_R = 0, V_R = -10V$ (ns)	$V_R = -10V$ (ns)		
10	500	1000	12	1	2799	1345	478	20000,	10000	1.3E-13	1.0E+13
.10	500	1000	12	1	2799	1345	478	20000,	10000	1.3E-13	1.0E+13
0.23	5	10	50	100	37	18	6	450,	5	1.3E-14	1.0E+13
0.34	5	10	100	100	72	35	12	450,	5	1.3E-14	1.4E+13

2) 50 OHM LOAD $\lambda = 800$ nm

$V_R = -0.01V$ MAX. (nA)	DARK CURRENT		BREAKDOWN VOLT. $I_{DR} = 10\mu A$ MIN. (V)	SHUNT RESISTANCE TYP. (Mohm)	TYPICAL CAPACITANCE			RISETIME ³⁾		NEP TYP. ($W\sqrt{Hz}$)	D* TYP. ($cm\sqrt{Hz}/W$)
	$V_R = -1.0V$ MAX. (nA)	$V_R = -10V$ MAX. (nA)			$V_R = 0V$ (pF)	$V_R = -1V$ (pF)	$V_R = -10V$ (pF)	$V_R = 0, V_R = -10V$ (ns)	$V_R = -10V$ (ns)		
100	—	—	10	200	290	—	—	—	—	8.9E-15	1.0E+14
350	—	—	10	50	220	—	—	—	—	1.8E-14	4.4E+14

3) 50 OHM LOAD $\lambda = 800$ nm

$V_R = -0.01V$ MAX. (nA)	DARK CURRENT		BREAKDOWN VOLT. $I_{DR} = 10\mu A$ MIN. (V)	SHUNT RESISTANCE TYP. (Mohm)	TYPICAL CAPACITANCE			RISETIME ³⁾		NEP TYP. ($W\sqrt{Hz}$)	D* TYP. ($cm\sqrt{Hz}/W$)
	$V_R = -1.0V$ MAX. (nA)	$V_R = -10V$ MAX. (nA)			$V_R = 0V$ (pF)	$V_R = -1V$ (pF)	$V_R = -10V$ (pF)	$V_R = 0, V_R = -10V$ (ns)	$V_R = -10V$ (ns)		
0.1	10	20.0	70	335	35	17	6	450	2	6.91E-15	1.3E+13
0.1	10	20.0	70	335	35	17	6	450	2	1.51E-14	1.2E+14
0.15	20	40	70	200	25	11	4	450	2	1.51E-14	9.4E+13
0.15	20	40	70	200	25	11	4	450	2	1.51E-14	9.4E+13
0	—	—	70	100	55	25	9	450	2	1.51E-14	6.6E+13
0	—	—	70	100	55	25	9	450	2	1.51E-14	6.6E+13

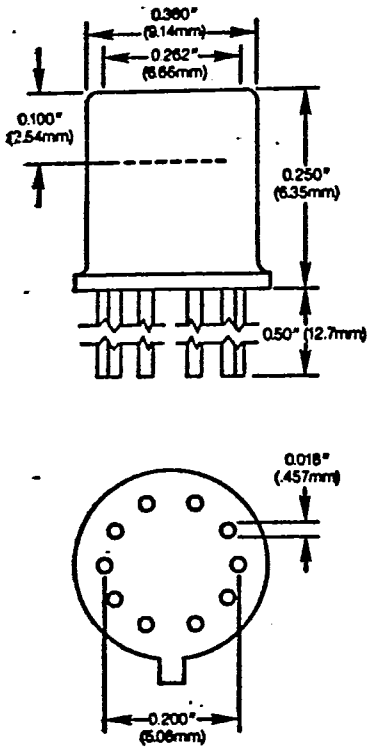

TO-74

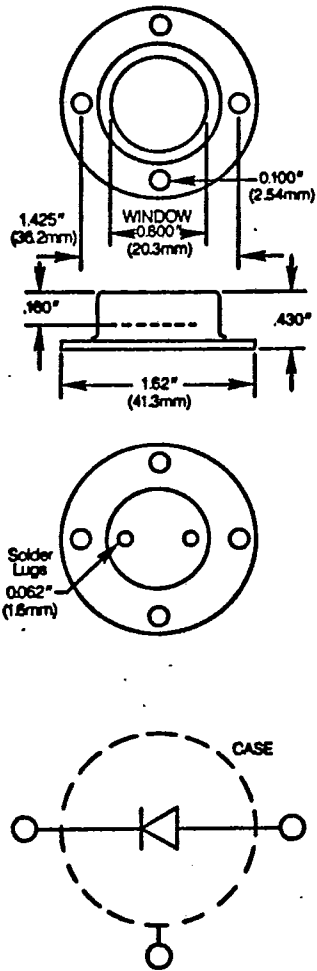

TO-3/3

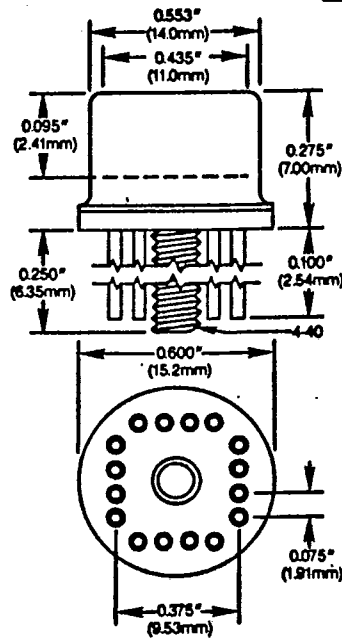

TO-8/16

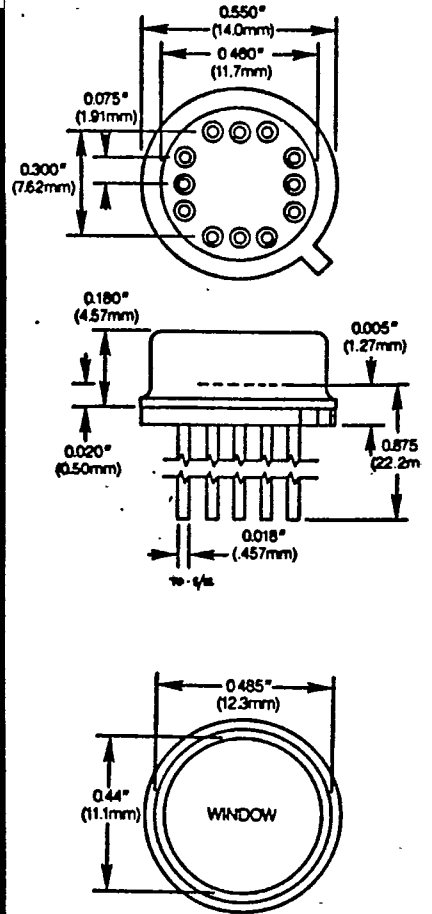

TO-8/12

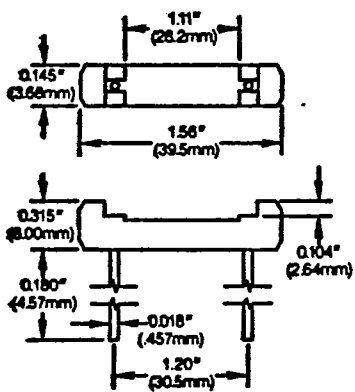

C1

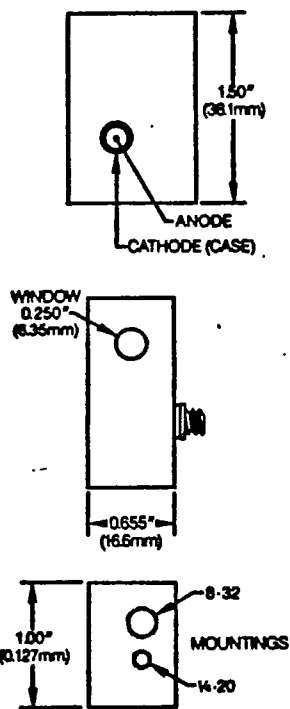

C5

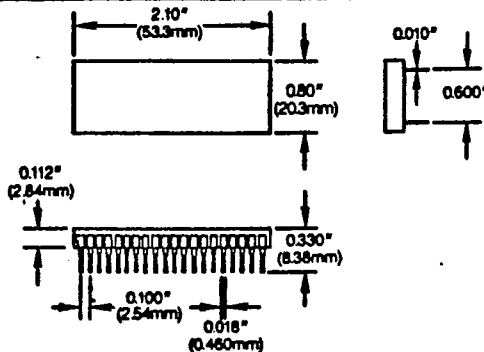
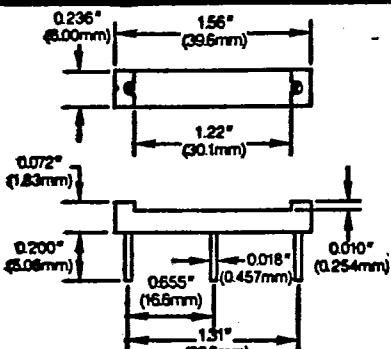
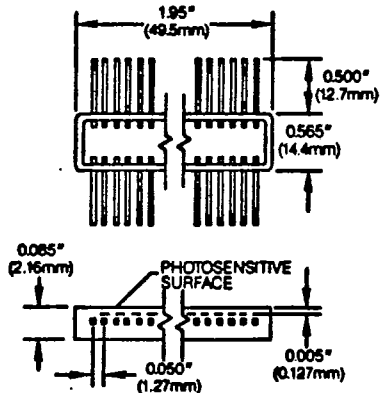

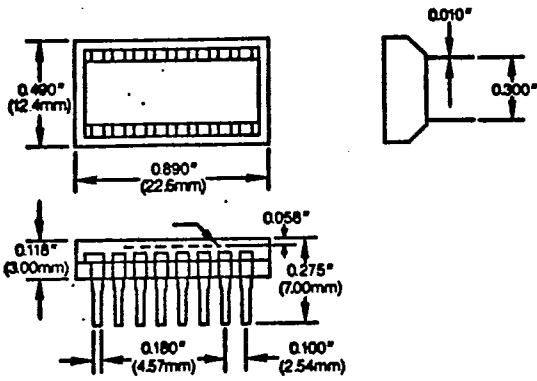

C7

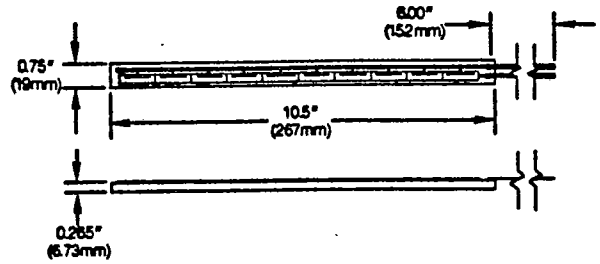

C8

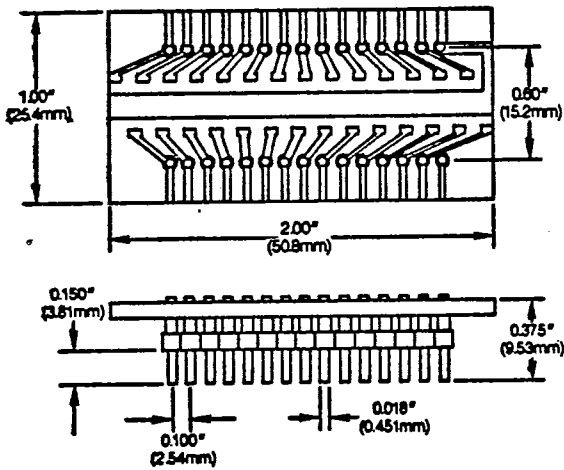

C9

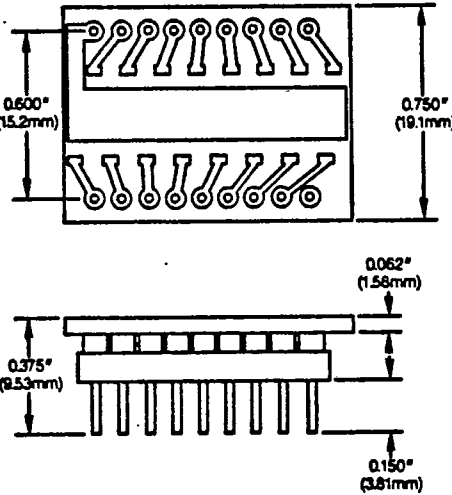

C10

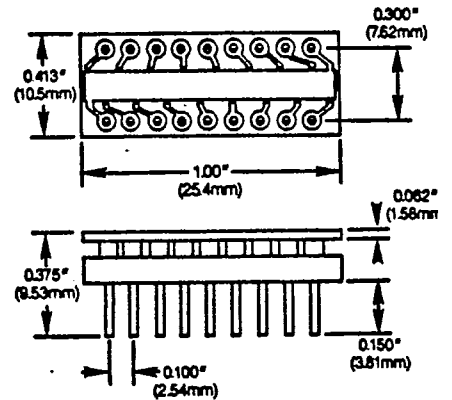

C11

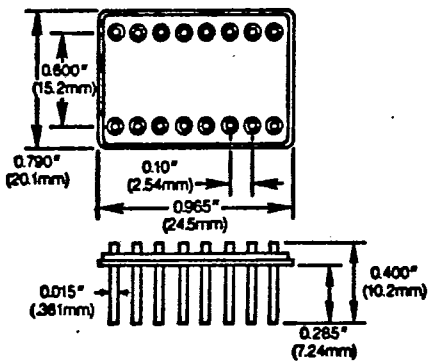

C12

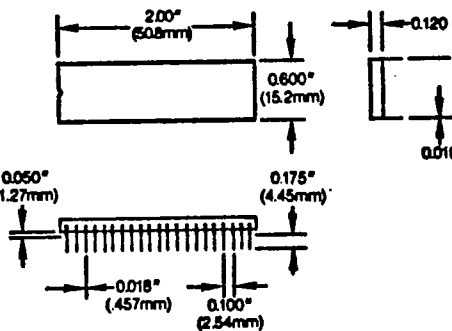

C13

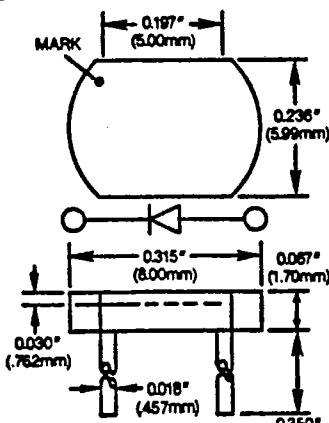
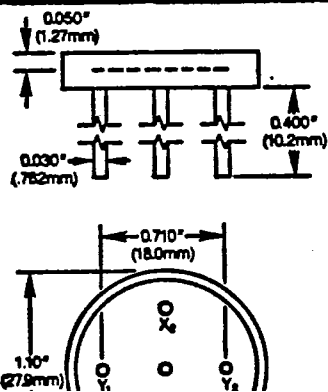
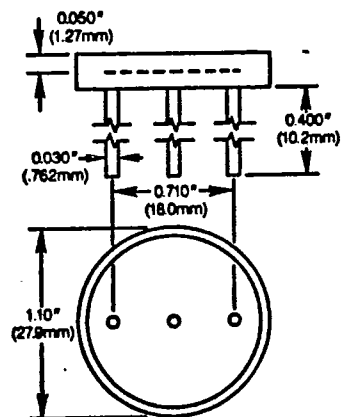

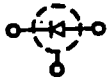
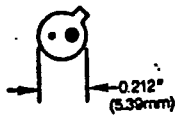
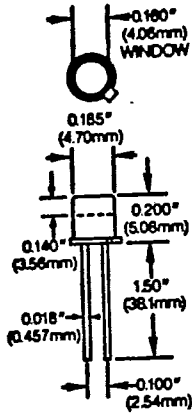

TO-18

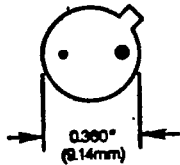
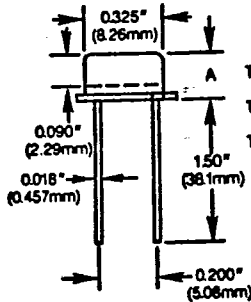
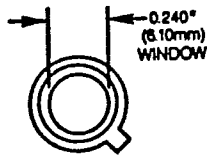

TO-5

- TO5 A = 0.170" (4.32mm)
- TO5M A = 0.780" (19.8mm)
- TO5C A = 0.425" (10.8mm)

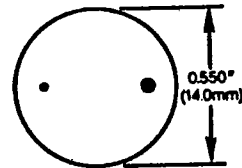
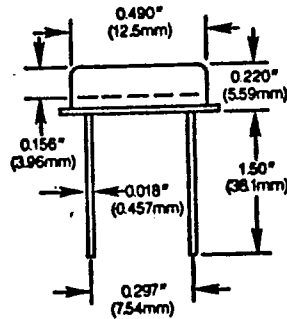
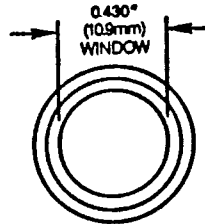

TO-8

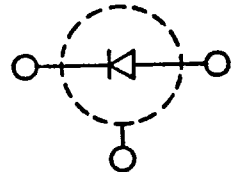
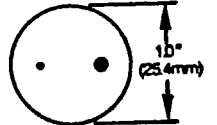
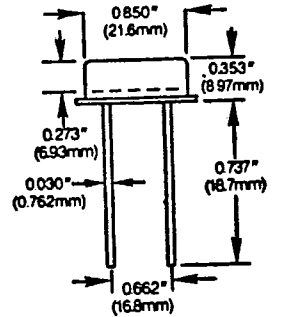
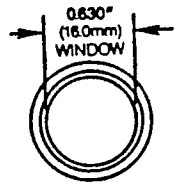

TO-3

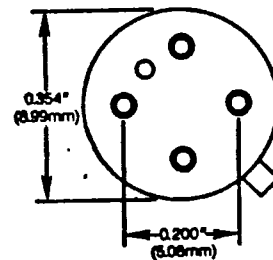
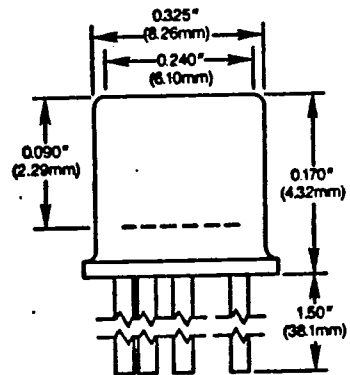
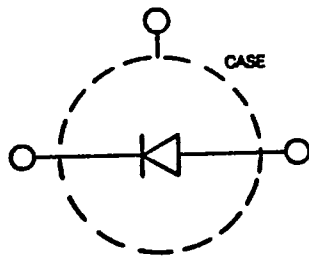
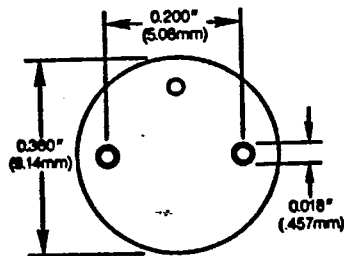
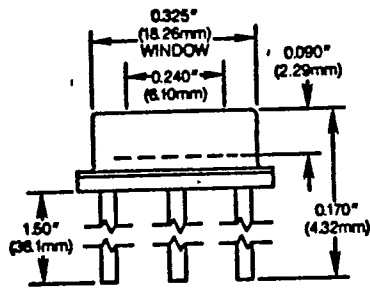
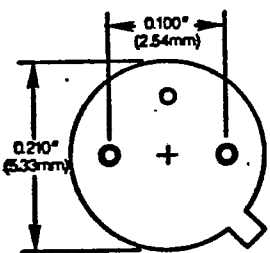
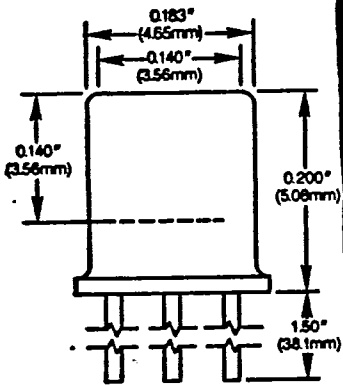

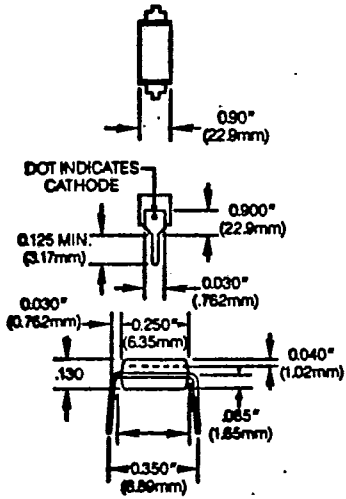

PDIP1

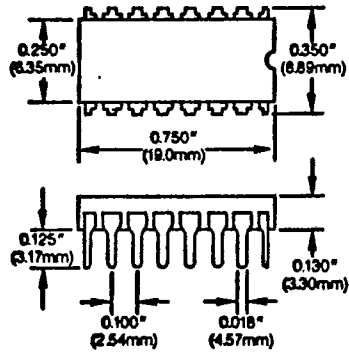

PDIP2

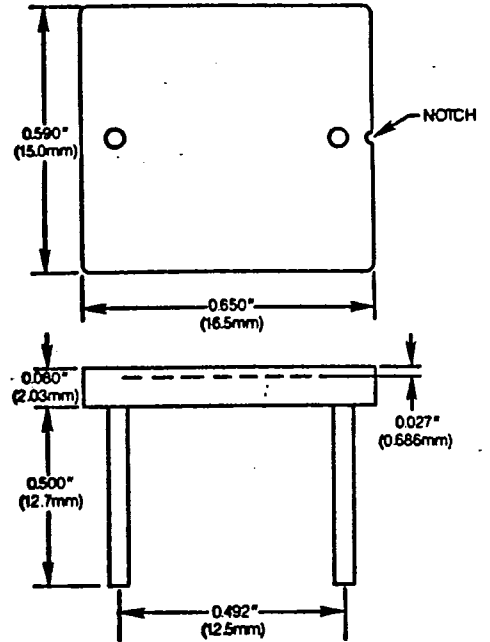

PII