

www.DataSheet4U.com

## Advanced Power MOSFET

## SSF8N90A

### FEATURES

- Avalanche Rugged Technology
- Rugged Gate Oxide Technology
- Lower Input Capacitance
- Improved Gate Charge
- Extended Safe Operating Area
- Lower Leakage Current : 25  $\mu$ A (Max.) @  $V_{DS} = 900V$
- Low  $R_{DS(ON)}$  : 1.247  $\Omega$  (Typ.)

$$BV_{DSS} = 900 V$$

$$R_{DS(on)} = 1.6 \Omega$$

$$I_D = 5.5 A$$

TO-3PF

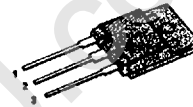

1.Gate 2. Drain 3. Source

### Absolute Maximum Ratings

Symbol	Characteristic	Value	Units
$V_{DSS}$	Drain-to-Source Voltage	900	V
$I_D$	Continuous Drain Current ( $T_c=25^\circ C$ )	5.5	A
	Continuous Drain Current ( $T_c=100^\circ C$ )	3.5	
$I_{DM}$	Drain Current-Pulsed ①	32	A
$V_{GS}$	Gate-to-Source Voltage	$\pm 30$	V
$E_{AS}$	Single Pulsed Avalanche Energy ②	801	mJ
$I_{AR}$	Avalanche Current ①	5.5	A
$E_{AR}$	Repetitive Avalanche Energy ①	9.5	mJ
dv/dt	Peak Diode Recovery dv/dt ③	1.5	V/ns
$P_D$	Total Power Dissipation ( $T_c=25^\circ C$ )	95	W
	Linear Derating Factor	0.76	
$T_J, T_{STG}$	Operating Junction and Storage Temperature Range	-55 to +150	$^\circ C$
$T_L$	Maximum Lead Temp. for Soldering Purposes, 1/8 " from case for 5-seconds	300	

### Thermal Resistance

Symbol	Characteristic	Typ.	Max.	Units
$R_{\theta JC}$	Junction-to-Case	--	1.32	$^\circ C/W$
$R_{\theta JA}$	Junction-to-Ambient	--	40	



www.DataSheet4U.com

### Electrical Characteristics ( $T_C=25^\circ\text{C}$ unless otherwise specified)

Symbol	Characteristic	Min.	Typ.	Max.	Units	Test Condition
$BV_{DSS}$	Drain-Source Breakdown Voltage	900	--	--	V	$V_{GS}=0V, I_D=250\mu A$
$\Delta BV/\Delta T_J$	Breakdown Voltage Temp. Coeff.	--	1.06	--	V/ $^\circ\text{C}$	$I_D=250\mu A$ See Fig 7
$V_{GS(th)}$	Gate Threshold Voltage	2.0	--	3.5	V	$V_{DS}=5V, I_D=250\mu A$
$I_{GSS}$	Gate-Source Leakage, Forward	--	--	100	nA	$V_{GS}=30V$
	Gate-Source Leakage, Reverse	--	--	-100	nA	$V_{GS}=-30V$
$I_{DSS}$	Drain-to-Source Leakage Current	--	--	25	$\mu A$	$V_{DS}=900V$
		--	--	250		$V_{DS}=720V, T_C=125^\circ\text{C}$
$R_{DS(on)}$	Static Drain-Source On-State Resistance	--	--	1.6	$\Omega$	$V_{GS}=10V, I_D=2.75A$ ④*
$g_{fs}$	Forward Transconductance	--	5.0	--	$\text{S}$	$V_{DS}=50V, I_D=2.75A$ ④
$C_{iss}$	Input Capacitance	--	2070	2690	pF	$V_{GS}=0V, V_{DS}=25V, f=1\text{MHz}$ See Fig 5
$C_{oss}$	Output Capacitance	--	185	215		
$C_{rss}$	Reverse Transfer Capacitance	--	78	90		
$t_{d(on)}$	Turn-On Delay Time	--	25	60	ns	$V_{DD}=450V, I_D=8A,$ $R_G=10\Omega$ See Fig 13 ④ ⑤
$t_r$	Rise Time	--	38	85		
$t_{d(off)}$	Turn-Off Delay Time	--	122	255		
$t_f$	Fall Time	--	41	90		
$Q_g$	Total Gate Charge	--	94	123	nC	$V_{DS}=720V, V_{GS}=10V,$ $I_D=8A$ See Fig 6 & Fig 12 ④ ⑤
$Q_{gs}$	Gate-Source Charge	--	14.9	--		
$Q_{gd}$	Gate-Drain ("Miller") Charge	--	43.5	--		

### Source-Drain Diode Ratings and Characteristics

Symbol	Characteristic	Min.	Typ.	Max.	Units	Test Condition
$I_S$	Continuous Source Current	--	--	5.5	A	Integral reverse pn-diode in the MOSFET
$I_{SM}$	Pulsed-Source Current ①	--	--	32		
$V_{SD}$	Diode Forward Voltage ④	--	--	1.4	V	$T_J=25^\circ\text{C}, I_S=5.5A, V_{GS}=0V$
$t_{rr}$	Reverse Recovery Time	--	620	--	ns	$T_J=25^\circ\text{C}, I_F=8A$
$Q_{rr}$	Reverse Recovery Charge	--	9.3	--	$\mu\text{C}$	$di_F/dt=100A/\mu\text{s}$ ④

#### Notes :

- Repetitive Rating : Pulse Width Limited by Maximum Junction Temperature
- $L=50\text{mH}, I_{AS}=5.5A, V_{DD}=50V, R_G=27\Omega$ , Starting  $T_J=25^\circ\text{C}$
- $I_{SD} \leq 8A, di/dt \leq 170A/\mu\text{s}, V_{DD} \leq BV_{DSS}$ , Starting  $T_J=25^\circ\text{C}$
- Pulse Test : Pulse Width = 250  $\mu\text{s}$ , Duty Cycle  $\leq 2\%$
- Essentially Independent of Operating Temperature

Fig 1. Output Characteristics

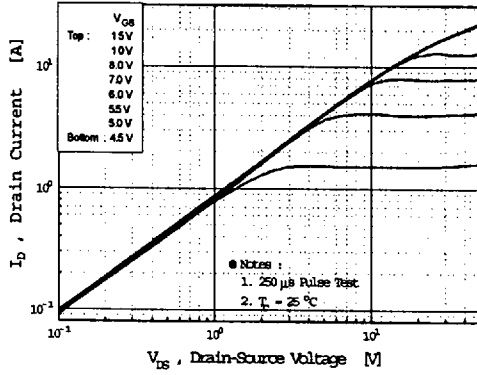

Fig 2. Transfer Characteristics

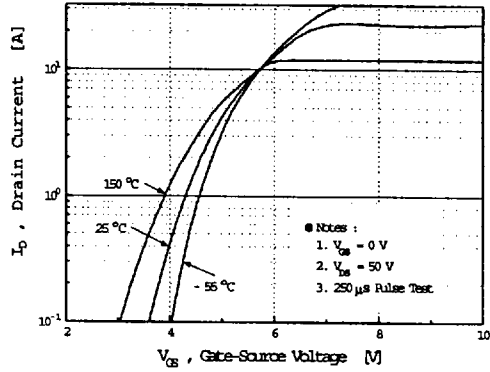

Fig 3. On-Resistance vs. Drain Current

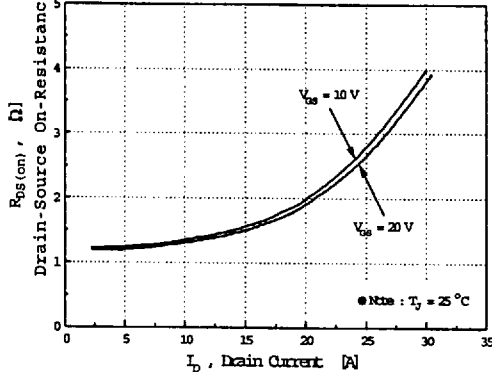

Fig 4. Source-Drain Diode Forward Voltage

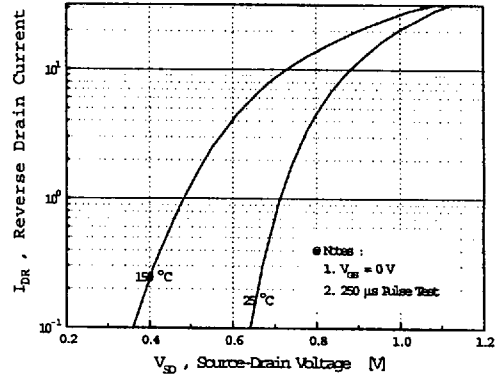

Fig 5. Capacitance vs. Drain-Source Voltage

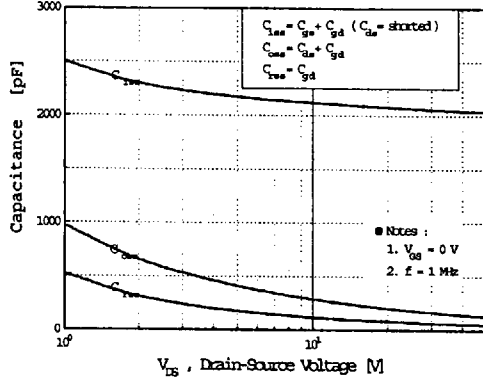
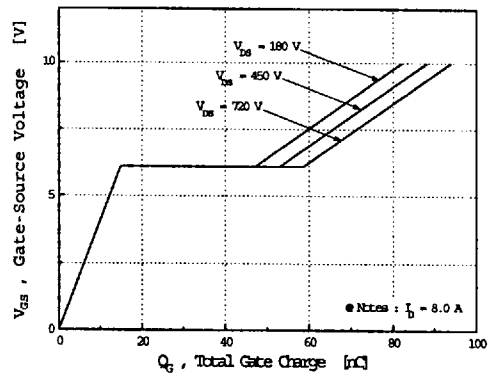
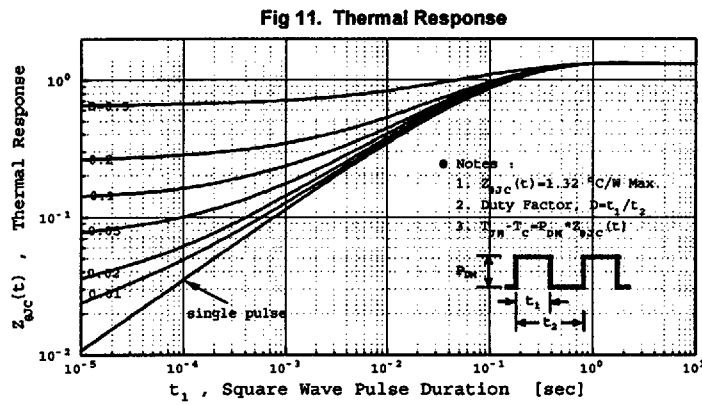
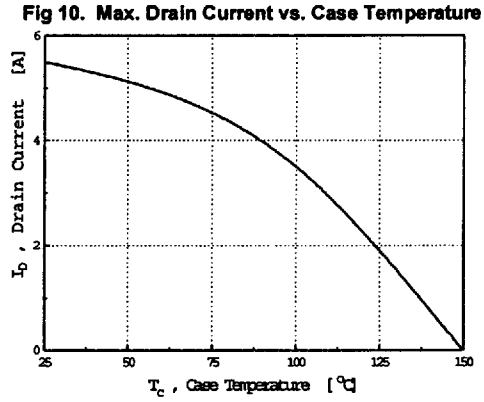
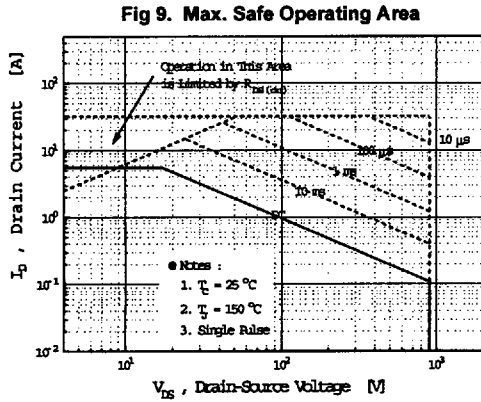
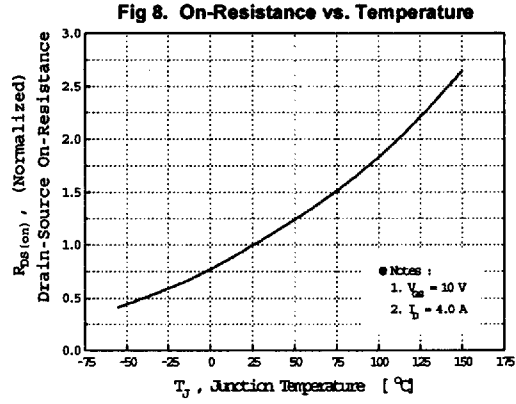
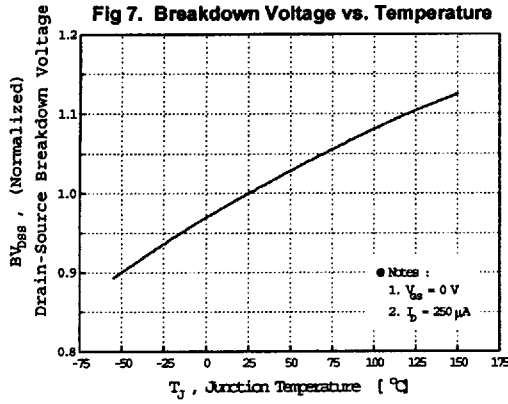

Fig 6. Gate Charge vs. Gate-Source Voltage



# SSF8N90A

## N-CHANNEL POWER MOSFET



y

Fig 12. Gate Charge Test Circuit & Waveform

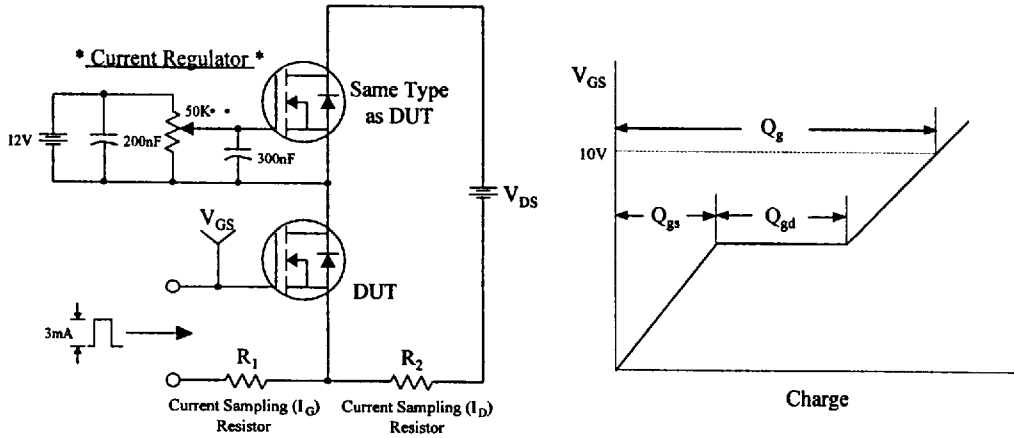

Fig 13. Resistive Switching Test Circuit & Waveforms

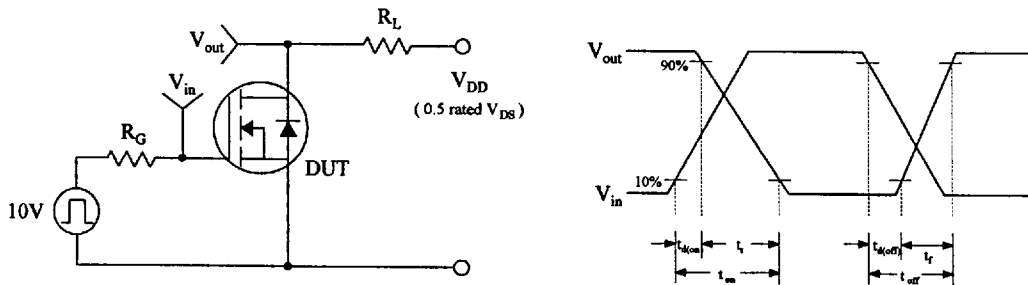

Fig 14. Unclamped Inductive Switching Test Circuit & Waveforms

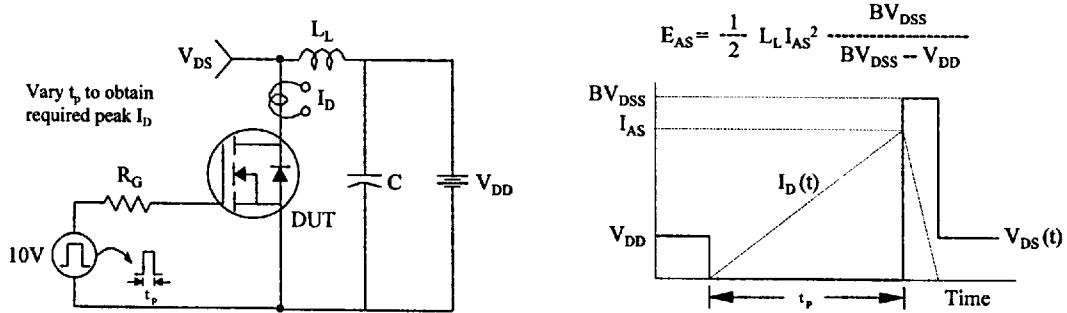
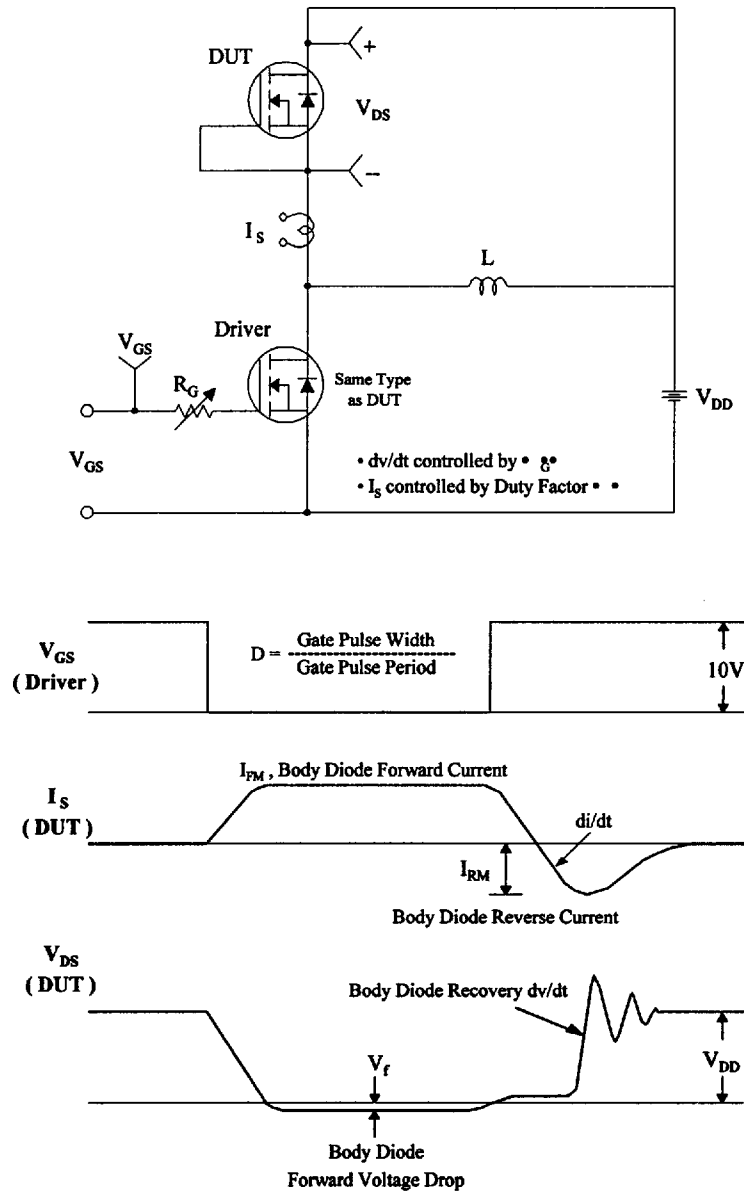
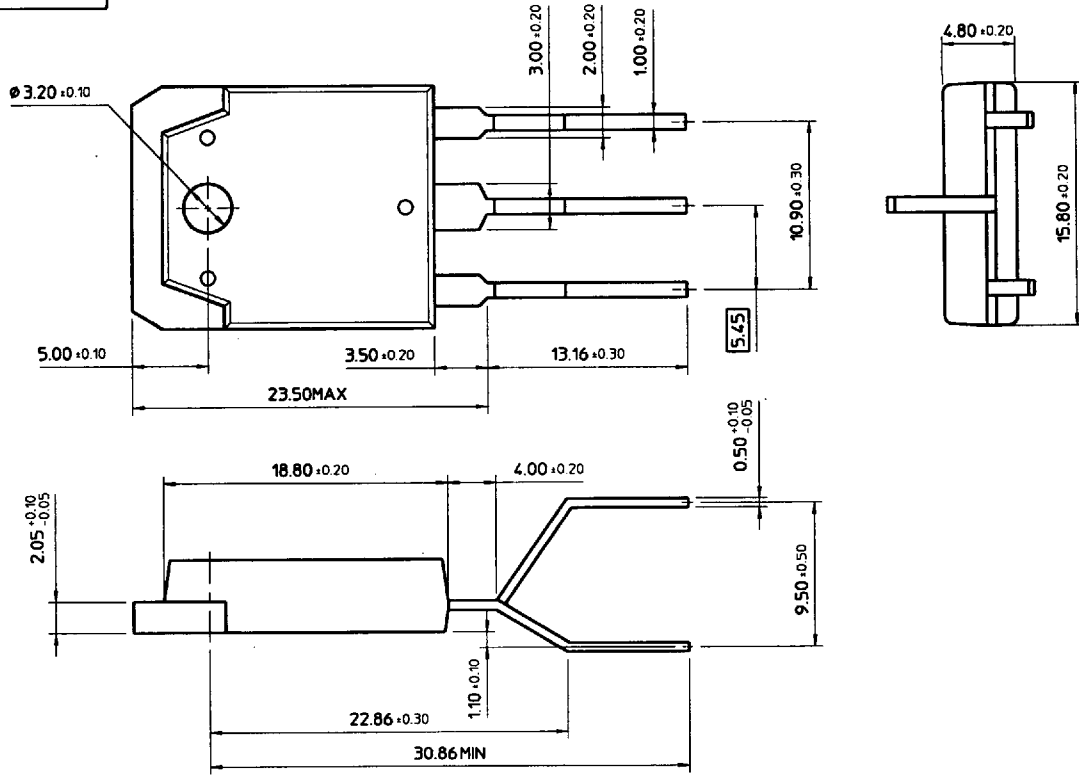

Fig 15. Peak Diode Recovery dv/dt Test Circuit & Waveforms



6

T0-3P (2)



T0-3PF (1)

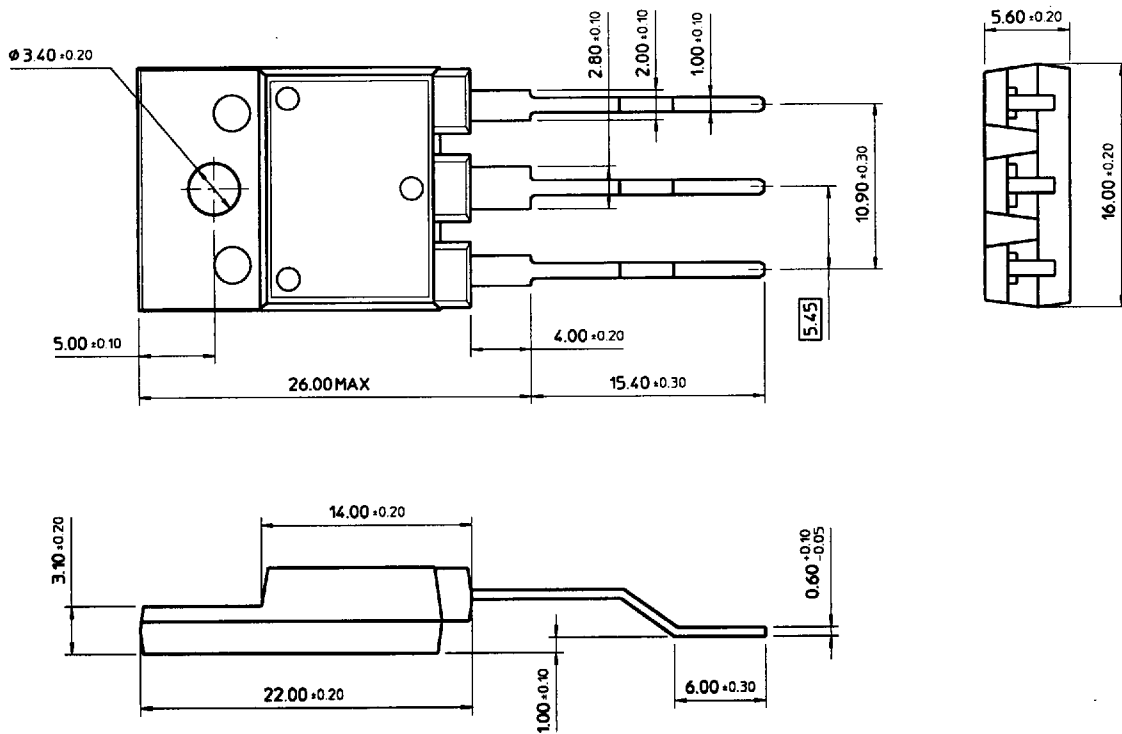

T0-3PF (2)

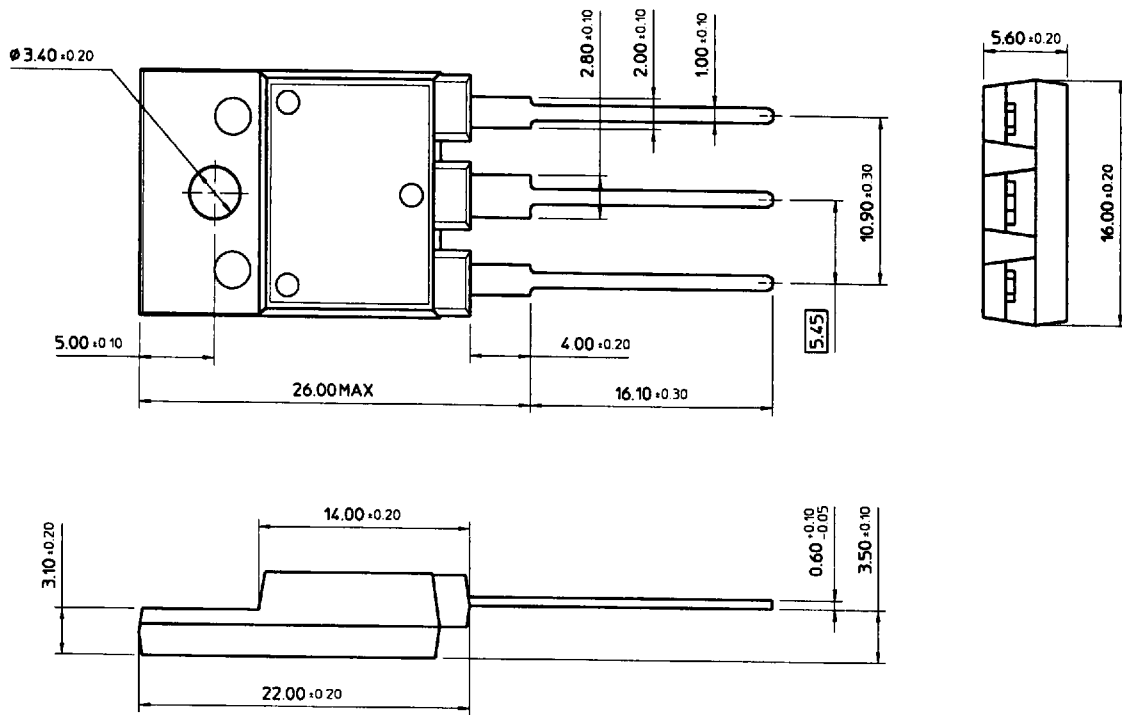

T0-3PF (3)

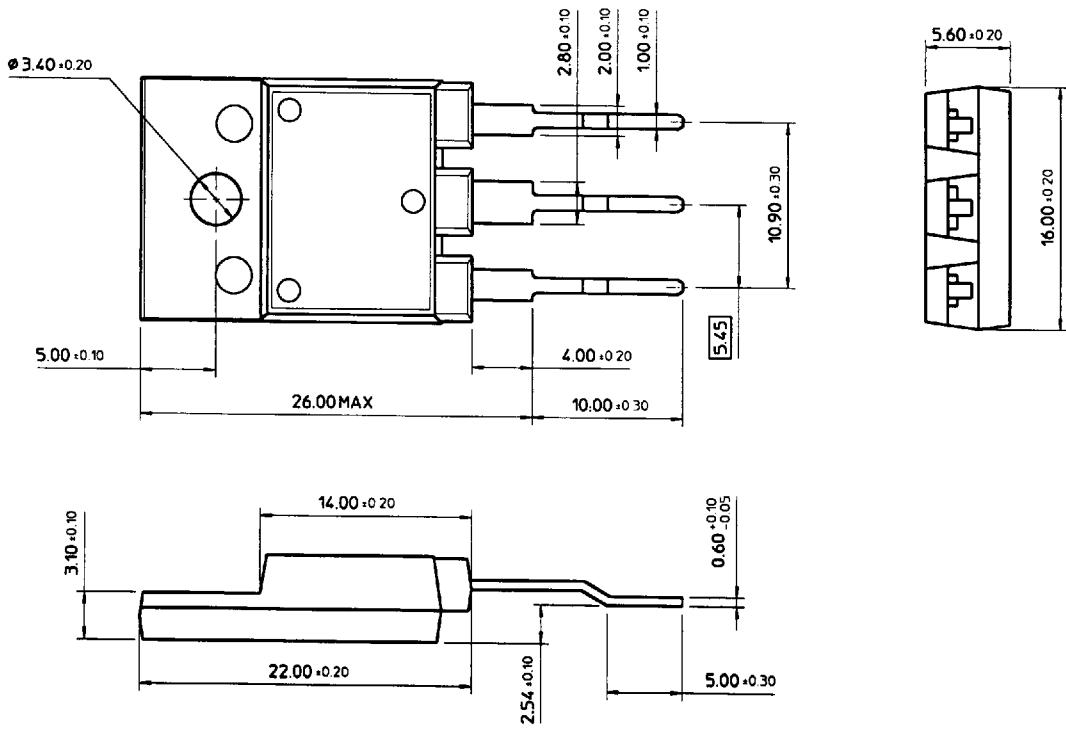



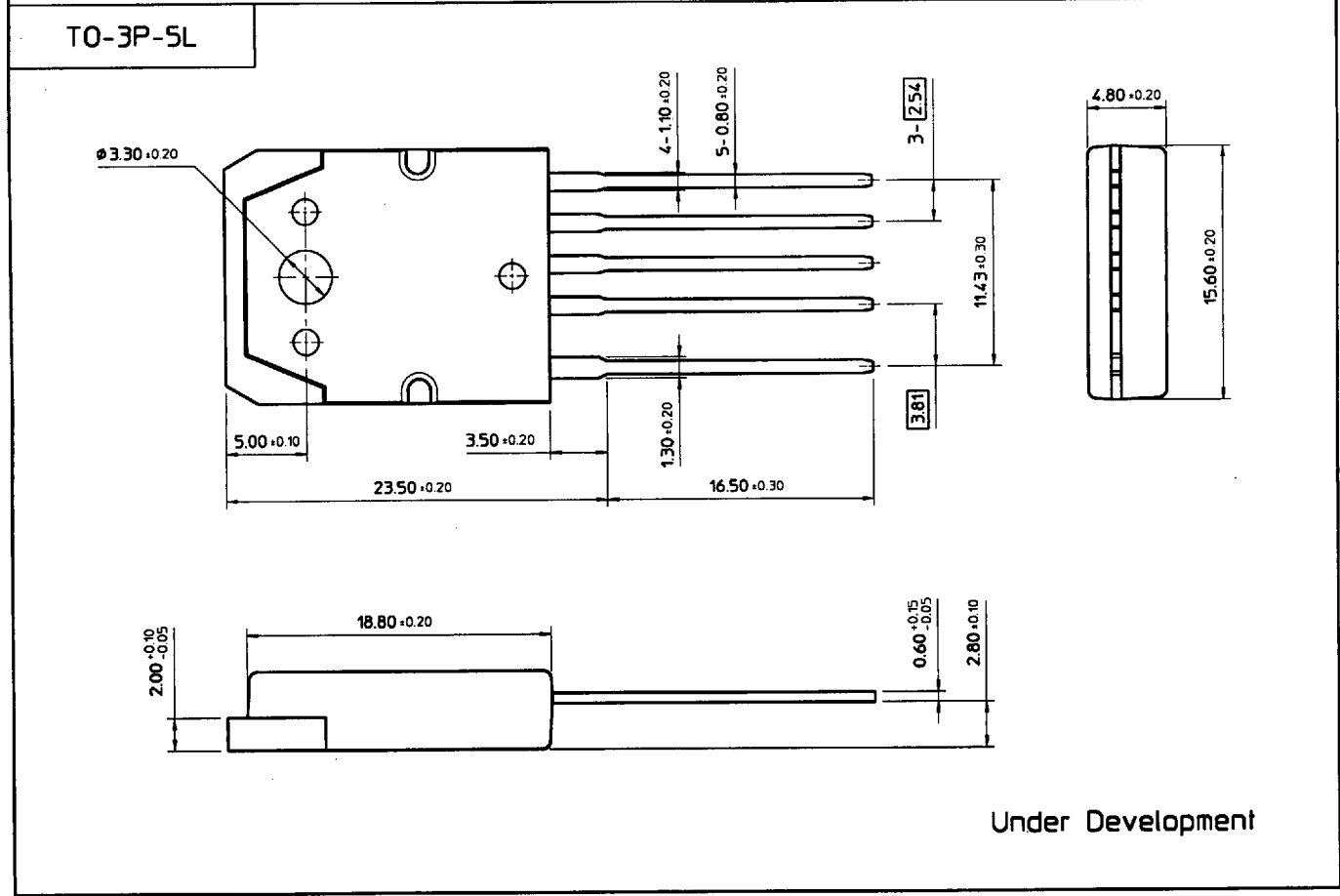
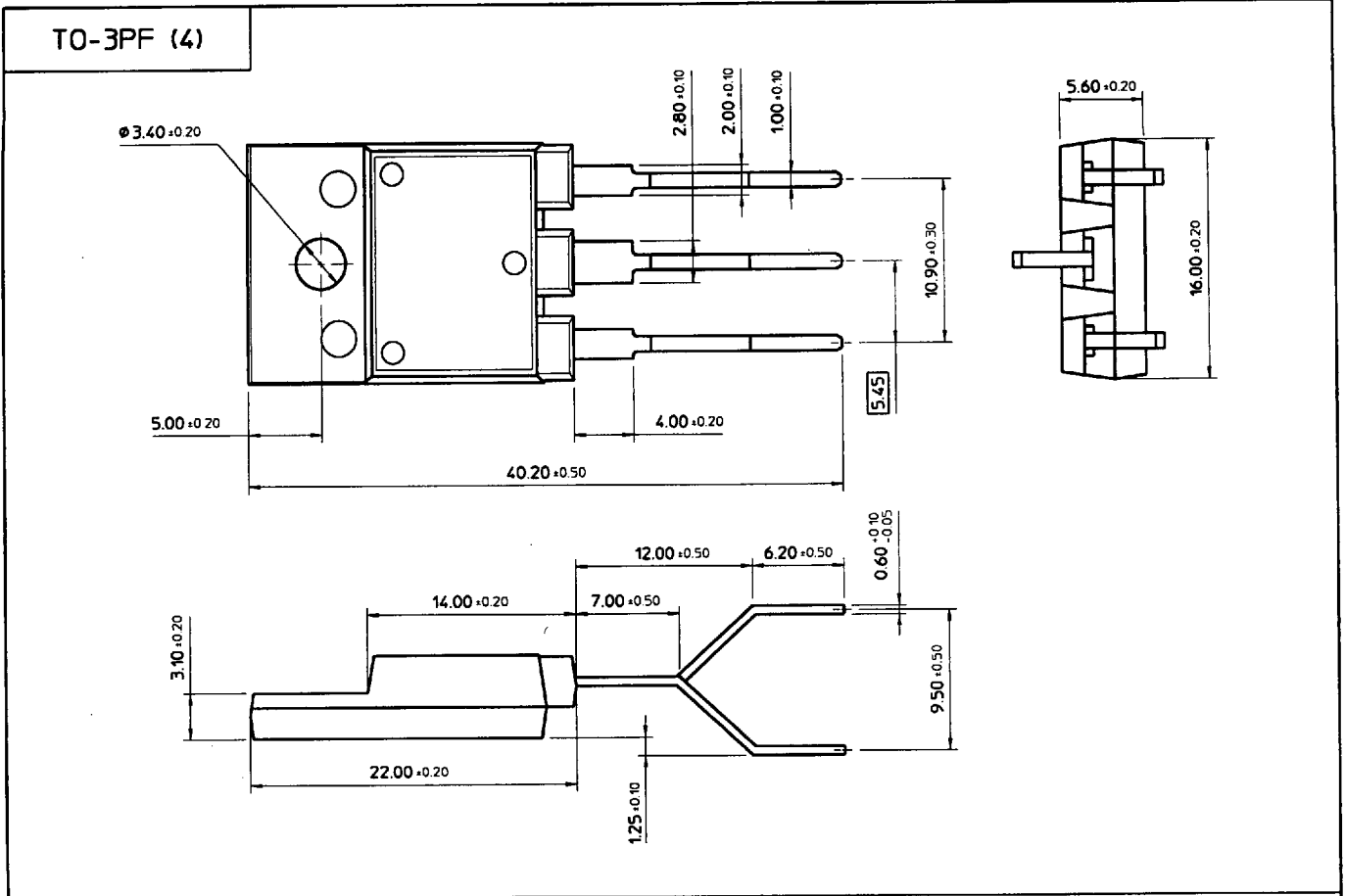

Under Development