



CEP76139/CEB76139

N-Channel Enhancement Mode Field Effect Transistor

FEATURES

- 30V, 75A, $R_{DS(ON)} = 7m\Omega$ @ $V_{GS} = 10V$.
 $R_{DS(ON)} = 10m\Omega$ @ $V_{GS} = 4.5V$.
- Super high dense cell design for extremely low $R_{DS(ON)}$.
- High power and current handing capability.
- Lead free product is acquired.
- 100% avalanche tested.
- TO-220 & TO-263 package.

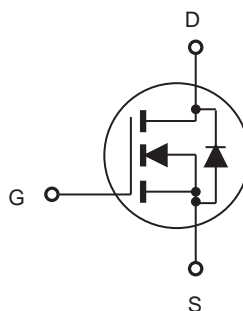
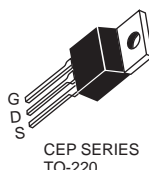
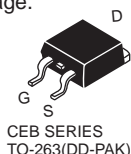

ABSOLUTE MAXIMUM RATINGS $T_C = 25^\circ C$ unless otherwise noted

Parameter	Symbol	Limit	Units
Drain-Source Voltage	V_{DS}	30	V
Gate-Source Voltage	V_{GS}	± 20	V
Drain Current-Continuous	I_D	75	A
Drain Current-Pulsed ^a	I_{DM}	225	A
Maximum Power Dissipation @ $T_C = 25^\circ C$ - Derate above $25^\circ C$	P_D	75	W
		0.5	W/ $^\circ C$
Single Pulsed Avalanche Energy ^d	E_{AS}	228	mJ
Single Pulsed Avalanche Current ^d	I_{AS}	100	A
Operating and Store Temperature Range	T_J, T_{stg}	-55 to 175	$^\circ C$

Thermal Characteristics

Parameter	Symbol	Limit	Units
Thermal Resistance, Junction-to-Case	$R_{\theta JC}$	2.0	$^\circ C/W$
Thermal Resistance, Junction-to-Ambient	$R_{\theta JA}$	62.5	$^\circ C/W$



CEP76139/CEB76139

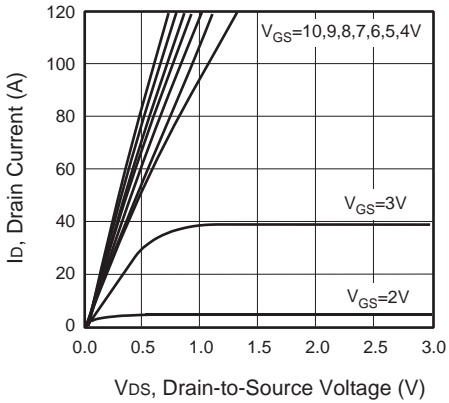

Figure 1. Output Characteristics

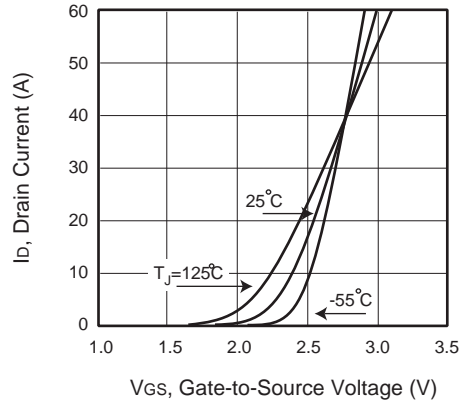

Figure 2. Transfer Characteristics

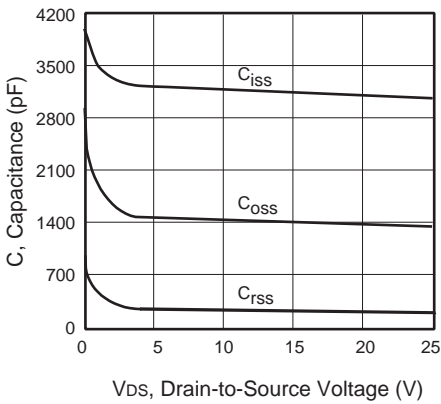

Figure 3. Capacitance

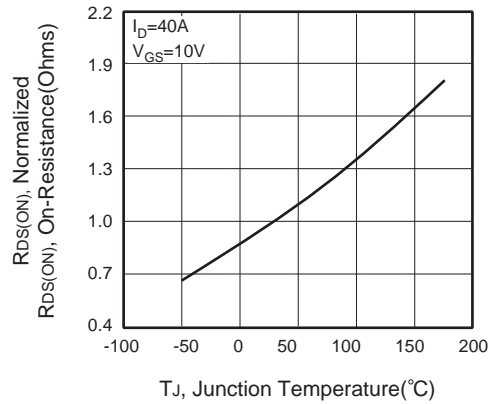

Figure 4. On-Resistance Variation with Temperature

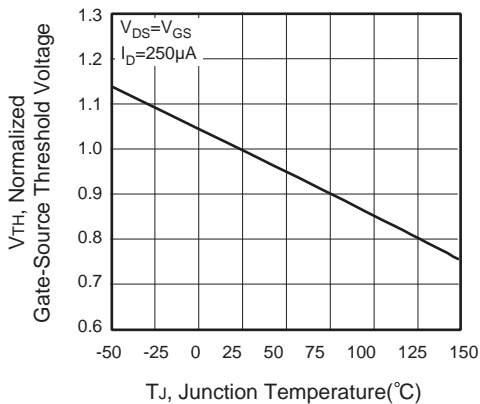

Figure 5. Gate Threshold Variation with Temperature

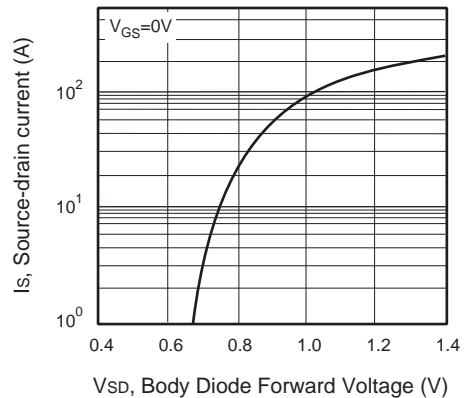

Figure 6. Body Diode Forward Voltage Variation with Source Current



CEP76139/CEB76139

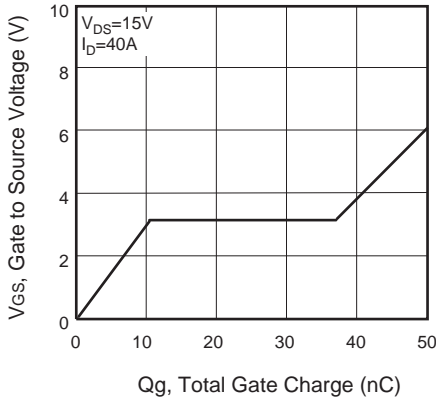

Figure 7. Gate Charge

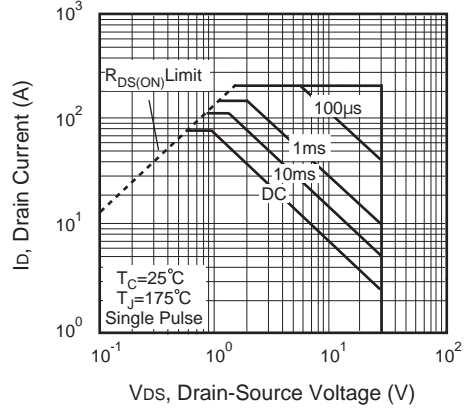

Figure 8. Maximum Safe Operating Area

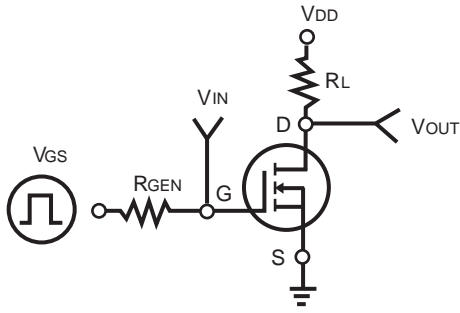

Figure 9. Switching Test Circuit

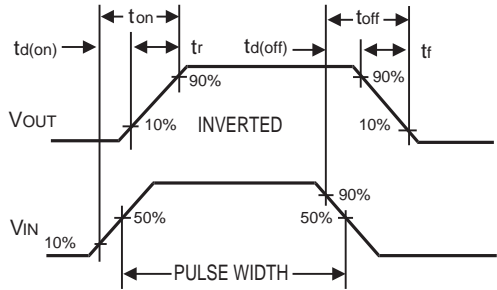

Figure 10. Switching Waveforms

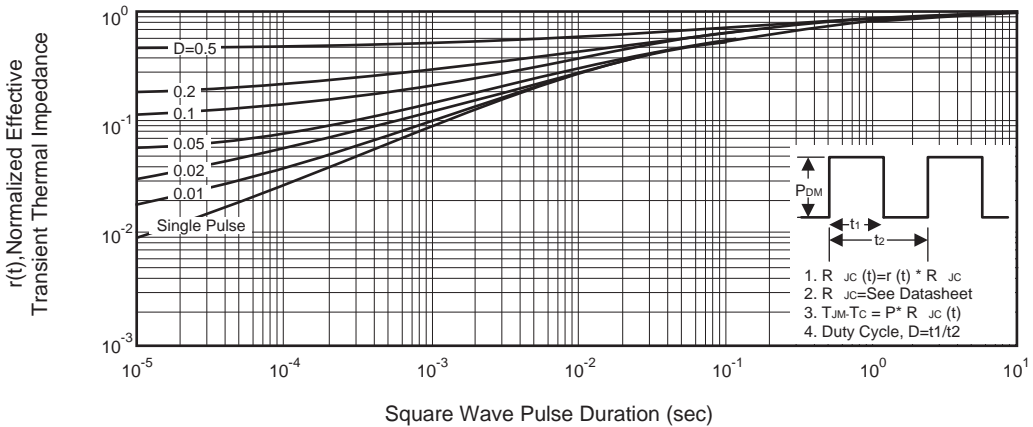

Figure 11. Normalized Thermal Transient Impedance Curve