

MOSEL-VITELIC V53C464A FAMILY
HIGH PERFORMANCE, LOW POWER
64K X 4 BIT FAST PAGE MODE
CMOS DYNAMIC RAM

HIGH PERFORMANCE V53C464A	60/60L	70/70L	80/80L	10/10L
Max. RAS Access Time, (t_{RAC})	60 ns	70 ns	80 ns	100 ns
Max. Column Address Access Time, (t_{CAA})	30 ns	35 ns	40 ns	45 ns
Min. Fast Page Mode Cycle Time, (t_{PC})	45 ns	50 ns	55 ns	65 ns
Min. Read-Write Cycle Time, (t_{RC})	115 ns	130 ns	145 ns	175 ns

LOW POWER V53C464AL	60L	70L	80L	10L
Max. CMOS Standby Current, (I_{DD6})	1.2 mA	1.2 mA	1.2 mA	1.2 mA

Features

- Low power dissipation for V53C464A-10
 - Operating Current—65 mA max.
 - TTL Standby Current—3.5 mA max.
- Low CMOS Standby Current
 - V53C464A—3 mA max.
 - V53C464AL—1.2 mA max.
- Read-Modify-Write, RAS-only Refresh, CAS-before-RAS Refresh capability
- Fast Page Mode operation for a sustained data rate greater than 21 MHz
- 256 Refresh cycles/4 ms
- Standard packages are 18 pin Plastic DIP and 18 pin PLCC

Description

The V53C464A is a high speed 65,536 x 4 bit CMOS dynamic random access memory. Fabricated with VICMOS III technology, the V53C464A offers a combination of size and features unattainable with NMOS technology: Fast Page Mode for high data bandwidth, fast usable speed, CMOS

standby current and, on request extended refresh for very low data retention power (V53C464AL).

All inputs and outputs are TTL compatible. Input and output capacitances are significantly lowered to allow increased system performance. Fast Page Mode operation allows random access of up to 256 (x4) bits within a row with cycle times as short as 45 ns. Because of static circuitry, the CAS clock is not in the critical timing path. The flow-through column address latches allow address pipelining while relaxing many critical system timing requirements for fast usable speed. These features make the V53C464A ideally suited for graphics, digital signal processing and high performance computing systems.

The V53C464AL-10 offers a maximum data retention power of 10 mW when operating in CMOS standby mode and performing RAS-only or CAS-before-RAS refresh cycles. For selected V53C464AL devices with Refresh Interval longer than 4 ms, consult the factory.

Device Usage Chart

Operating Temperature Range	Package Outline		Access Time (ns)				Power		Temperature Mark
	P	J	60	70	80	100	Low	Std.	
0°C to 70°C	•	•	•	•	•	•	•	•	Blank

MOSEL-VITELIC

V53C464A

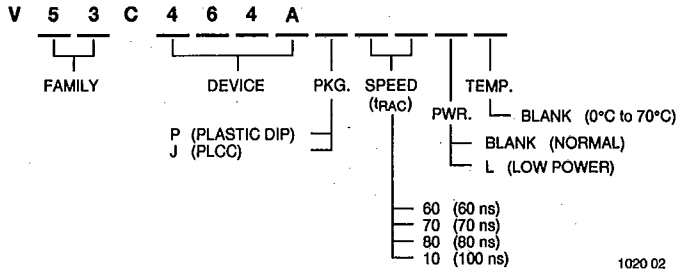

Description	Pkg.	Pin Count
Plastic DIP	P	18
PLCC	J	18

1020 02

**18 Lead Plastic DIP
PIN CONFIGURATION
Top View**

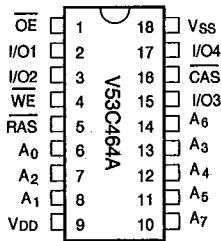

**18 Lead PLCC Package
PIN CONFIGURATION
Top View**

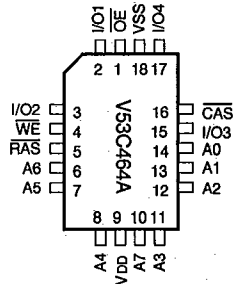

LOGIC SYMBOL

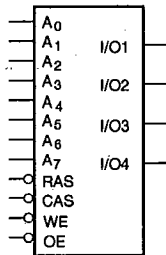

1020 03

Absolute Maximum Ratings*

- Ambient Temperature
- Under Bias-10°C to +80°C
- Storage Temperature (plastic)-55°C to +125°C
- Voltage on any Pin Except V_{DD}
- Relative to V_{SS}-1.0V to +7.0 V
- Voltage on V_{DD} relative to V_{SS}-1.0V to +7.0 V
- Data Out Current50 mA
- Power Dissipation1.0 W

*Note: Operation above Absolute Maximum Ratings can adversely affect device reliability.

Capacitance*

T_A = 25°C, V_{DD} = 5 V ±10%, V_{SS} = 0 V

Symbol	Parameter	Typ.	Max.	Unit
C _{IN1}	Address	3	4	pF
C _{IN2}	$\overline{\text{RAS}}$, $\overline{\text{CAS}}$, WE, $\overline{\text{OE}}$	4	5	pF
C _{OUT}	I/O	4	6	pF

*Note: Capacitance is sampled and not 100% tested

MOSEL-VITELIC

V53C464A

Block Diagram

64K x 4

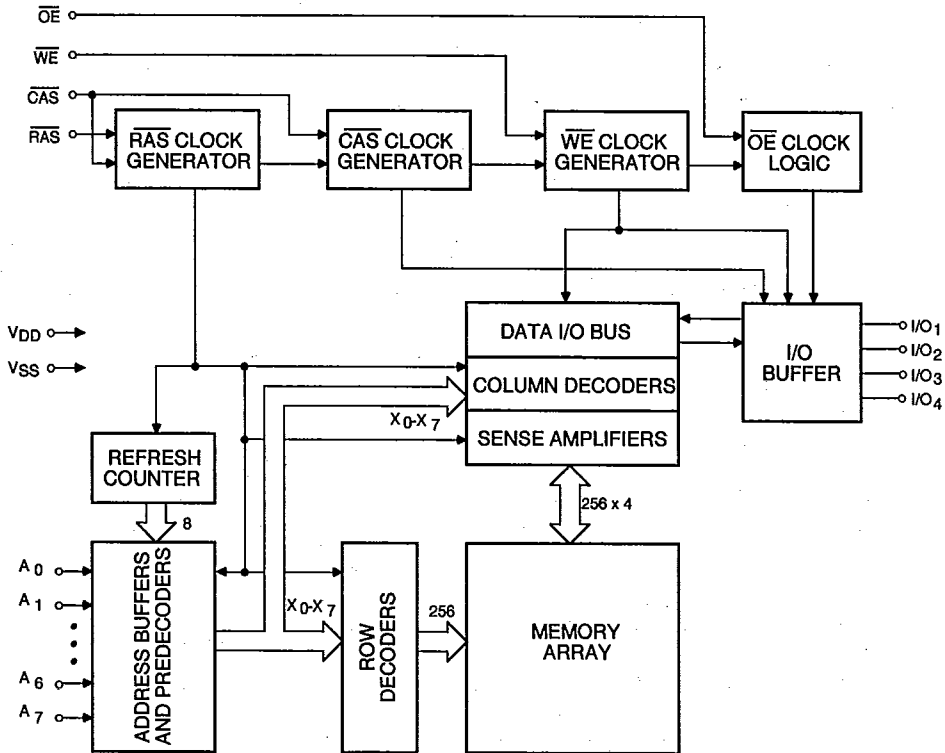

MOSEL-VITELIC

V53C464A

DC and Operating Characteristics (1-2)

$T_A = 0^\circ\text{C}$ to 70°C , $V_{DD} = 5\text{ V} \pm 10\%$, $V_{SS} = 0\text{ V}$, unless otherwise specified.

Symbol	Parameter	Access Time	V53C464A		V53C464AL		Unit	Test Conditions	Notes
			Min.	Max.	Min.	Max.			
I_{LI}	Input Leakage Current (any input pin)		-10	10	-10	10	μA	$V_{SS} \leq V_{IN} \leq V_{DD}$	
I_{LO}	Output Leakage Current (for High-Z State)		-10	10	-10	10	μA	$V_{SS} \leq V_{OUT} \leq V_{DD}$ RAS, CAS at V_{IH}	
I_{DD1}	V_{DD} Supply Current, Operating	60		80		80	mA	$t_{RC} = t_{RC}(\text{min.})$	1,2
		70		75		75			
		80		70		70			
		100		65		65			
I_{DD2}	V_{DD} Supply Current, TTL Standby			3.5		2.0	mA	$\overline{\text{RAS}}, \overline{\text{CAS}}$ at V_{IH} other inputs $\geq V_{SS}$	
I_{DD3}	V_{DD} Supply Current, $\overline{\text{RAS}}$ -Only Refresh	60		80		80	mA	$t_{RC} = t_{RC}(\text{min.})$	2
		70		75		75			
		80		65		65			
		100		55		55			
I_{DD4}	V_{DD} Supply Current, Fast Page Mode Operation	60		50		50	mA	Minimum Cycle	1,2
		70		45		45			
		80		40		40			
		100		35		35			
I_{DD5}	V_{DD} Supply Current, Standby, Output Enabled			4		2.5	mA	$\overline{\text{RAS}} = V_{IH}, \overline{\text{CAS}} = V_{IL}$ other inputs $\geq V_{SS}$	1
I_{DD6}	V_{DD} Supply Current, CMOS Standby			3		1.2	mA	$\overline{\text{RAS}} \geq V_{DD} - 0.2\text{ V}$, $\overline{\text{CAS}}$ at V_{IH} , other inputs $\geq V_{SS}$	
V_{IL}	Input Low Voltage		-1	0.8	-1	0.8	V		3
V_{IH}	Input High Voltage		2.4	$V_{DD} + 1$	2.4	$V_{DD} + 1$	V		3
V_{OL}	Output Low Voltage			0.4		0.4	V	$I_{OL} = 4.2\text{ mA}$	
V_{OH}	Output High Voltage		2.4		2.4		V	$I_{OH} = -5\text{ mA}$	

MOSEL-VITELIC

V53C464A

AC Characteristics

$T_A = 0^\circ\text{C}$ to 70°C , $V_{DD} = 5\text{ V} \pm 10\%$, $V_{SS} = 0\text{ V}$, unless otherwise noted
 AC Test conditions, input pulse levels 0 to 3 V

#	JEDEC Symbol	Symbol	Parameter	60/60L		70/70L		80/80L		10/10L		Unit	Notes
				Min.	Max.	Min.	Max.	Min.	Max.	Min.	Max.		
1	t_{RL1RH1}	t_{RAS}	\overline{RAS} Pulse Width	60	75K	70	75K	80	75K	100	75K	ns	
2	t_{RL2RL2}	t_{RC}	Read or Write Cycle Time	115		130		145		175		ns	
3	t_{RH2RL2}	t_{RP}	\overline{RAS} Precharge Time	45		50		55		65		ns	
4	t_{RL1CH1}	t_{CSH}	\overline{CAS} Hold Time	60		70		80		100		ns	
5	t_{CL1CH1}	t_{CAS}	\overline{CAS} Pulse Width	20		20		20		25		ns	
6	t_{RL1CL1}	t_{RCD}	\overline{RAS} to \overline{CAS} Delay	20	40	25	45	25	50	25	65	ns	4
7	t_{WH2CL2}	t_{RCS}	Read Command Setup Time	0		0		0		0		ns	
8	t_{AVRL2}	t_{ASR}	Row Address Setup Time	0		0		0		0		ns	
9	t_{RL1AX}	t_{RAH}	Row Address Hold Time	10		15		15		15		ns	
10	t_{AVCL2}	t_{ASC}	Column Address Setup Time	0		0		0		0		ns	
11	t_{CL1AX}	t_{CAH}	Column Address Hold Time	10		15		15		20		ns	
12	$t_{CL1RH1(R)}$	$t_{RSH(R)}$	\overline{RAS} Hold Time (Read Cycle)	20		25		30		35		ns	
13	t_{CH2RL2}	t_{CRP}	\overline{CAS} to \overline{RAS} Precharge Time	10		15		15		15		ns	
14	t_{CH2WX}	t_{RCH}	Read Command Hold Time Referenced to \overline{CAS}	5		5		5		5		ns	5
15	t_{RH2WX}	t_{RRH}	Read Command Hold Time Referenced to \overline{RAS}	5		5		5		5		ns	5
16	$t_{OEL1RH2}$	t_{ROH}	\overline{RAS} Hold Time Referenced to \overline{OE}	15		15		20		25		ns	
17	t_{GL1QV}	t_{OAC}	Access Time from \overline{OE}		15		15		20		25	ns	
18	t_{CL1QV}	t_{CAC}	Access Time from \overline{CAS}		20		20		20		25	ns	6,7
19	t_{RL1QV}	t_{RAC}	Access Time from \overline{RAS}		60		70		80		100	ns	6,8,9
20	t_{AVQV}	t_{CAA}	Access Time from Column Address		30		35		40		45	ns	6,7,10

MOSEL-VITELIC

V53C464A

AC Characteristics (Cont'd.)

#	JEDEC Symbol	Symbol	Parameter	60/60L		70/70L		80/80L		10/10L		Unit	Notes
				Min.	Max.	Min.	Max.	Min.	Max.	Min.	Max.		
21	t _{CL1QX}	t _{LZ}	\overline{OE} or \overline{CAS} to Low-Z Output	0		0		0		0		ns	17
22	t _{CH2QZ}	t _{HZ}	\overline{OE} or \overline{CAS} to High-Z Output	0	10	0	15	0	20	0	25	ns	17
23	t _{RL1AX}	t _{AR}	Column Address Hold Time from \overline{RAS}	50		55		60		70		ns	
24	t _{RL1AV}	t _{RAD}	\overline{RAS} to Column Address Delay Time	15	30	20	35	20	40	20	55	ns	11
25	t _{CL1RH1(W)}	t _{RSH(W)}	\overline{RAS} or \overline{CAS} Hold Time in Write Cycle	20		25		30		35		ns	
26	t _{WL1GH1}	t _{CWL}	Write Command to \overline{CAS} Lead Time	20		25		30		35		ns	
27	t _{WL1CL2}	t _{WCS}	Write Command Setup Time	0		0		0		0		ns	12,13
28	t _{CL1WH1}	t _{WCH}	Write Command Hold Time	10		15		15		20		ns	
29	t _{WL1WH1}	t _{WP}	Write Pulse Width	10		15		15		20		ns	
30	t _{RL1WH1}	t _{WCR}	Write Command Hold Time from \overline{RAS}	50		55		60		70		ns	
31	t _{WL1RH1}	t _{RWL}	Write Command to \overline{RAS} Lead Time	20		25		30		35		ns	
32	t _{DVWL2}	t _{DS}	Data In Setup Time	0		0		0		0		ns	14
33	t _{WL1DX}	t _{DH}	Data In Hold Time	10		15		15		20		ns	14
34	t _{WL1GL2}	t _{WOH}	Write to \overline{OE} Hold Time	10		20		20		25		ns	
35	t _{GH2DX}	t _{OED}	\overline{OE} to Data Delay Time	15		20		25		30		ns	
36	t _{RL2RL2(RMW)}	t _{RWC}	Read-Modify-Write Cycle Time	170		185		210		250		ns	
37	t _{RL1RH1(RMW)}	t _{RRW}	Read-Modify-Write Cycle \overline{RAS} Pulse Width	105		125		145		175		ns	
38	t _{CL1WL2}	t _{CWD}	\overline{CAS} to \overline{WE} Delay	40		50		60		70		ns	12

MOSEL-VITELIC**V53C464A****AC Characteristics (Cont'd.)**

#	JEDEC Symbol	Symbol	Parameter	60/60L		70/70L		80/80L		10/10L		Unit	Notes
				Min.	Max.	Min.	Max.	Min.	Max.	Min.	Max.		
39	t _{RL1WL2}	t _{RWD}	$\overline{\text{RAS}}$ to $\overline{\text{WE}}$ Delay in Read-Modify-Write Cycle	80		95		110		135		ns	12
40	t _{CL1CH1}	t _{CRW}	$\overline{\text{CAS}}$ Pulse Width (RMW)	65		80		95		110		ns	
41	t _{AVWL2}	t _{AWD}	Col. Address to $\overline{\text{WE}}$ Delay	50		60		70		80		ns	12
42	t _{CL2CL2}	t _{PC}	Fast Page Mode Read or Write Cycle Time	45		50		55		65		ns	
43	t _{CH2CL2}	t _{CP}	$\overline{\text{CAS}}$ Precharge Time	10		10		10		10		ns	
44	t _{AVRH1}	t _{CAR}	Column Address to $\overline{\text{RAS}}$ Setup Time	30		35		40		45		ns	
45	t _{CH2QV}	t _{CAP}	Access Time from Column Precharge		40		45		50		55	ns	6, 7
46	t _{RL1DX}	t _{DHR}	Data in Hold Time Referenced to $\overline{\text{RAS}}$	50		55		60		70		ns	
47	t _{CL1RL2}	t _{CSR}	$\overline{\text{CAS}}$ Setup Time $\overline{\text{CAS}}$ -before- $\overline{\text{RAS}}$ Refresh	10		10		10		10		ns	
48	t _{RH2CL2}	t _{RPC}	$\overline{\text{RAS}}$ to $\overline{\text{CAS}}$ Precharge Time	0		0		0		0		ns	
49	t _{RL1CH1}	t _{CHR}	$\overline{\text{CAS}}$ Hold Time $\overline{\text{CAS}}$ -before- $\overline{\text{RAS}}$ Refresh	15		20		25		30		ns	
50	t _{CL2CL2 (RMW)}	t _{PCM}	Fast Page Mode Read-Modify-Write Cycle Time	85		105		120		140		ns	
	t _T	t _T	Transition Time (Rise and Fall)	3	50	3	50	3	50	3	50	ns	15
		t _{RI}	Refresh Interval (256 Cycles)		4		4		4		4	ms	16

MOSEL-VITELIC**V53C464A**

Notes:

1. I_{DD} is dependent on output loading when the device output is selected. Specified I_{DD} (max.) is measured with the output open.
2. I_{DD} is dependent upon the number of address transitions. Specified I_{DD} (max.) is measured with a maximum of two transitions per address cycle in Fast Page Mode.
3. Specified V_{IL} (min.) is steady state operating. During transitions, V_{IL} (min.) may undershoot to -1.0 V for a period not to exceed 20 ns. All AC parameters are measured with V_{IL} (min.) $\geq V_{SS}$ and V_{IH} (max.) $\leq V_{DD}$.
4. t_{RCD} (max.) is specified for reference only. Operation within t_{RCD} (max.) limits insures that t_{RAC} (max.) and t_{CAA} (max.) can be met. If t_{RCD} is greater than the specified t_{RCD} (max.), the access time is controlled by t_{CAA} and t_{CAC} .
5. Either t_{RRH} or t_{RCH} must be satisfied for a Read Cycle to occur.
6. Measured with a load equivalent to two TTL inputs and 100 pF.
7. Access time is determined by the longest of t_{CAA} , t_{CAC} and t_{CAP} .
8. Assumes that $t_{RAD} \leq t_{RAD}$ (max.). If t_{RAD} is greater than t_{RAD} (max.), t_{RAC} will increase by the amount that t_{RAD} exceeds t_{RAD} (max.).
9. Assumes that $t_{RCD} \leq t_{RCD}$ (max.). If t_{RCD} is greater than t_{RCD} (max.), t_{RAC} will increase by the amount that t_{RCD} exceeds t_{RCD} (max.).
10. Assumes that $t_{RAD} \geq t_{RAD}$ (max.).
11. Operation within the t_{RAD} (max.) limit insures that t_{RAC} (max.) can be met. t_{RAD} (max.) is specified as a reference point only. If t_{RAD} is greater than the specified t_{RAD} (max.) limit, the access time is controlled by t_{CAA} and t_{CAC} .
12. t_{WCS} , t_{RWD} , t_{AWD} and t_{CWD} are not restrictive operating parameters.
13. t_{WCS} (min.) must be satisfied in an Early Write Cycle.
14. t_{DS} and t_{DH} are referenced to the latter occurrence of \overline{CAS} or \overline{WE} .
15. t_T is measured between V_{IH} (min.) and V_{IL} (max.). AC-measurements assume $t_T = 5$ ns.
16. An initial 200 μ s pause and 8 \overline{RAS} -containing cycles are required when exiting an extended period of bias without clocks. An extended period of time without clocks is defined as one that exceeds the specified Refresh Interval.
17. Assumes a three-state test load of 5 pF and a 380 Ohm Thevenin equivalent.

MOSEL-VITELIC

V53C464A

Waveforms of Read Cycle

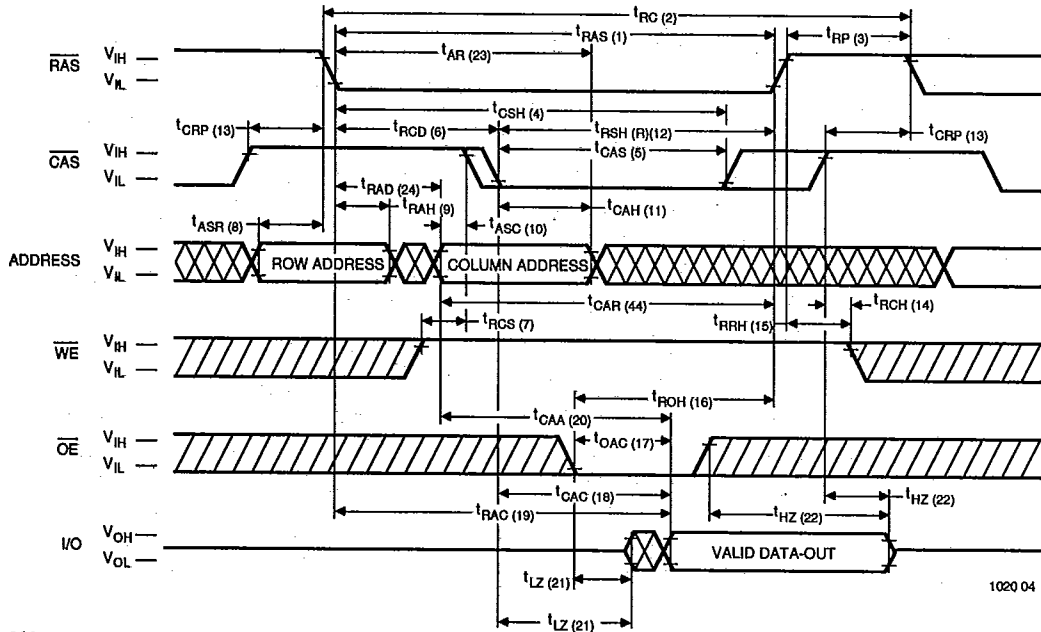

2

Waveforms of Early Write Cycle

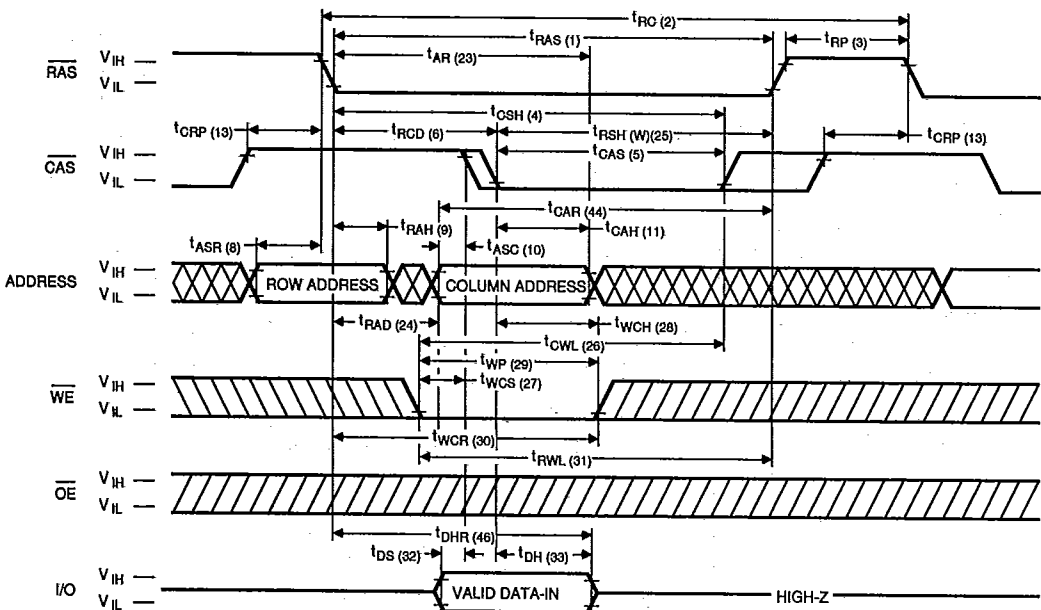

MOSEL-VITELIC

V53C464A

Waveforms of OE Controlled Write Cycle

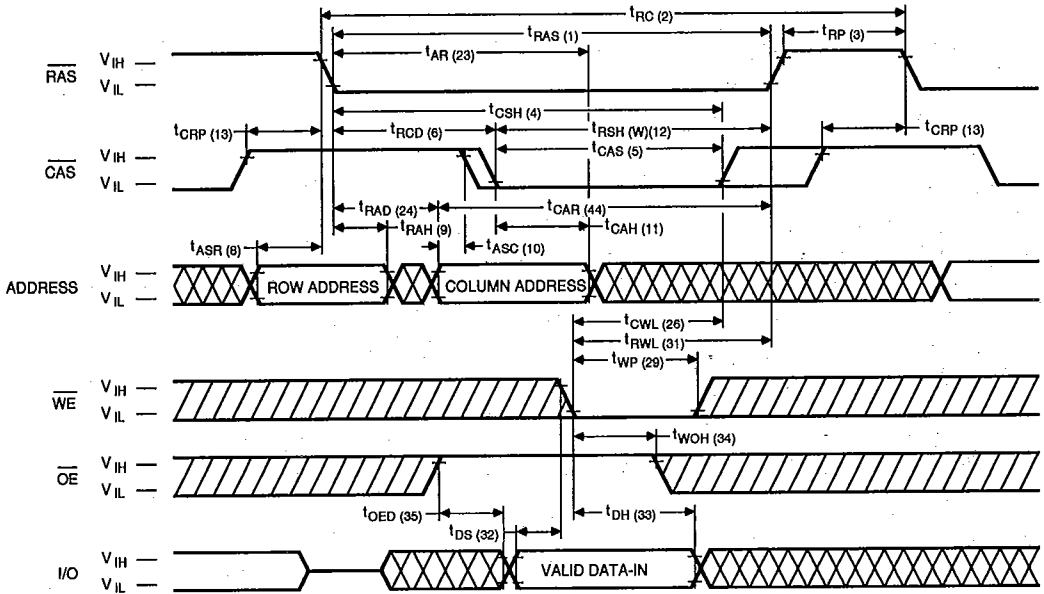

1020 06

Waveforms of Read-Modify-Write Cycle

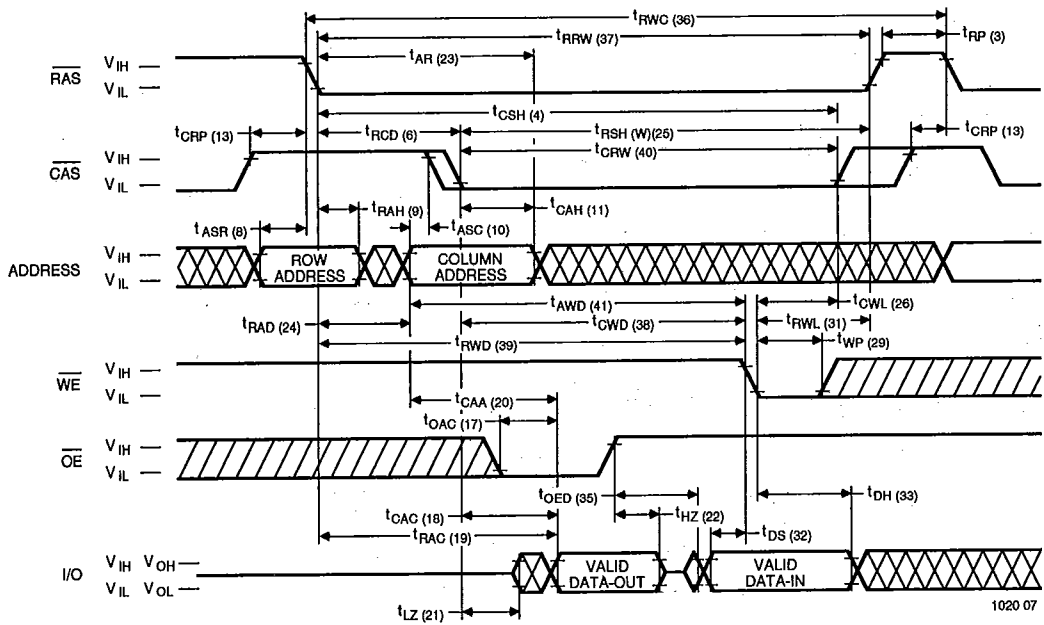

1020 07

MOSEL-VITELIC

V53C464A

Waveforms of Fast Page Mode Read Cycle

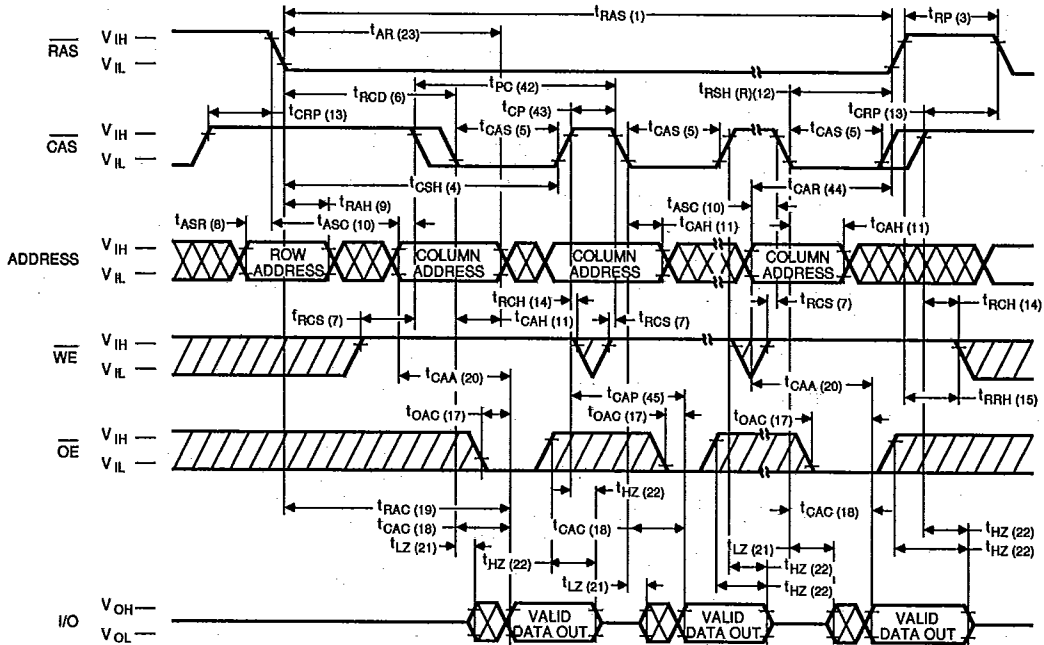

1020 08

Waveforms of Fast Page Mode Write Cycle

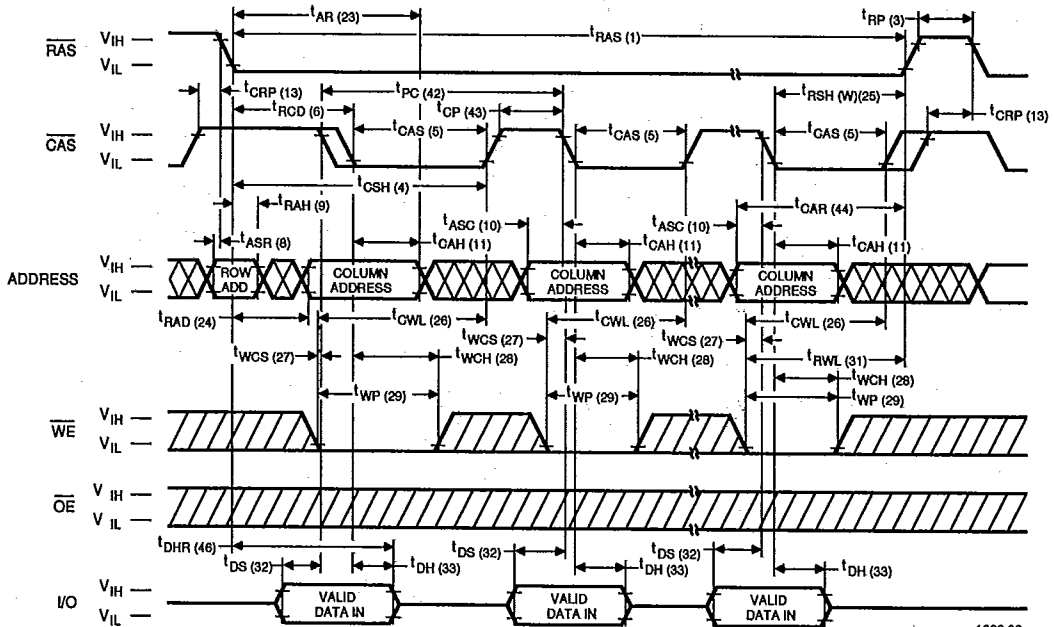

1020 08

MOSEL-VITELIC

V53C464A

Waveforms of Fast Page Mode Read-Write Cycle

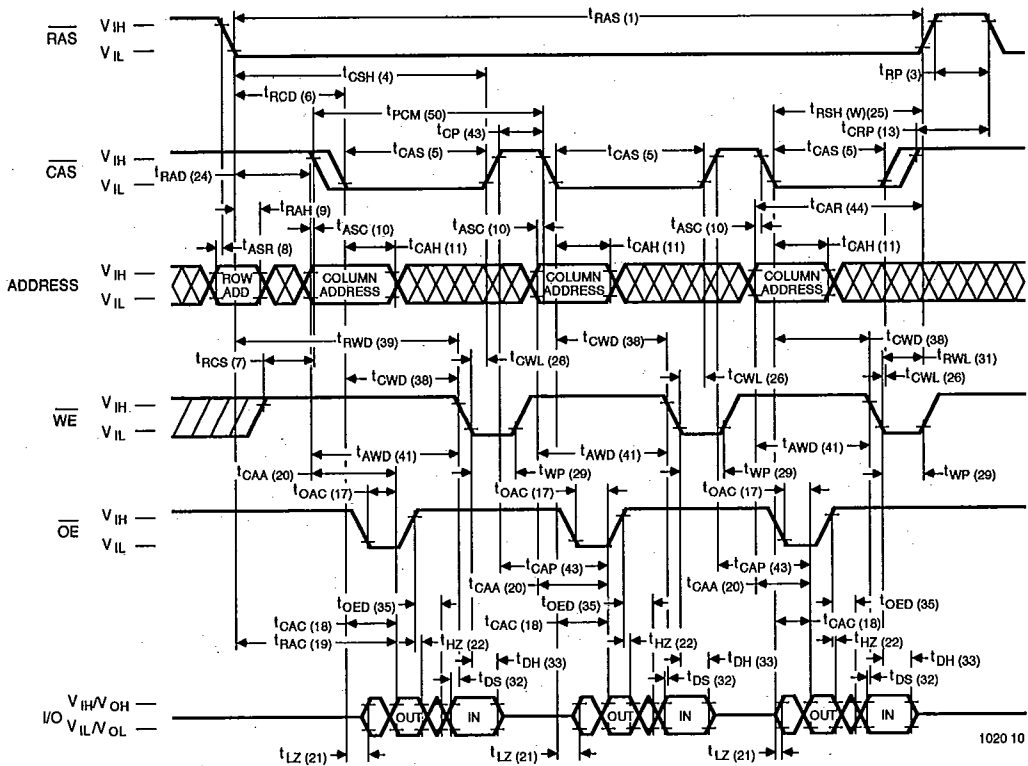

Waveforms of RAS-Only Refresh Cycle

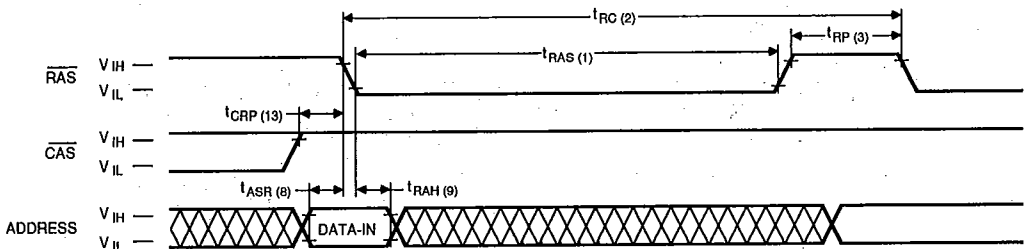

NOTE: \overline{WE} , \overline{OE} = Don't care

MOSEL-VITELIC

V53C464A

Waveforms of CAS-before-RAS Refresh Cycle

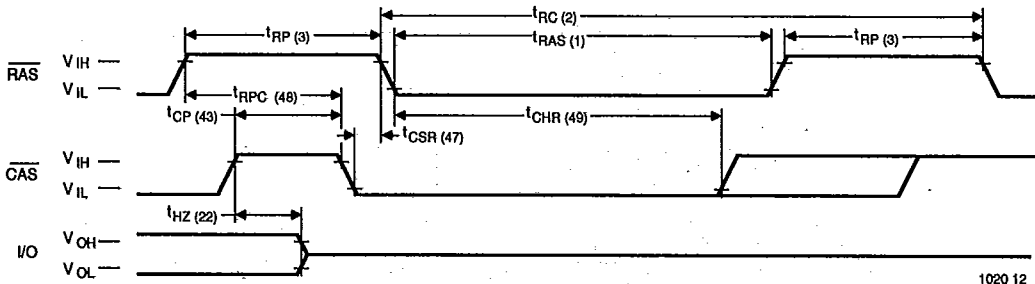

1020 12

NOTE: \overline{WE} , \overline{OE} , A_0 , A_7 = Don't care

Waveforms of Hidden Refresh Cycle (Read)

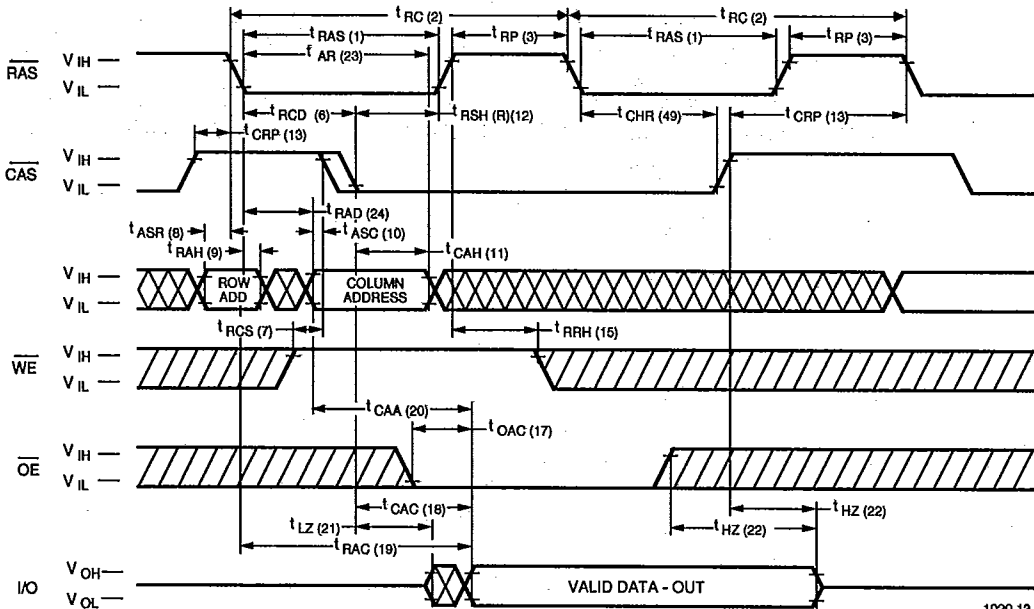

1020 13

MOSEL-VITELIC

V53C464A

Waveforms of Hidden Refresh Cycle (Write)

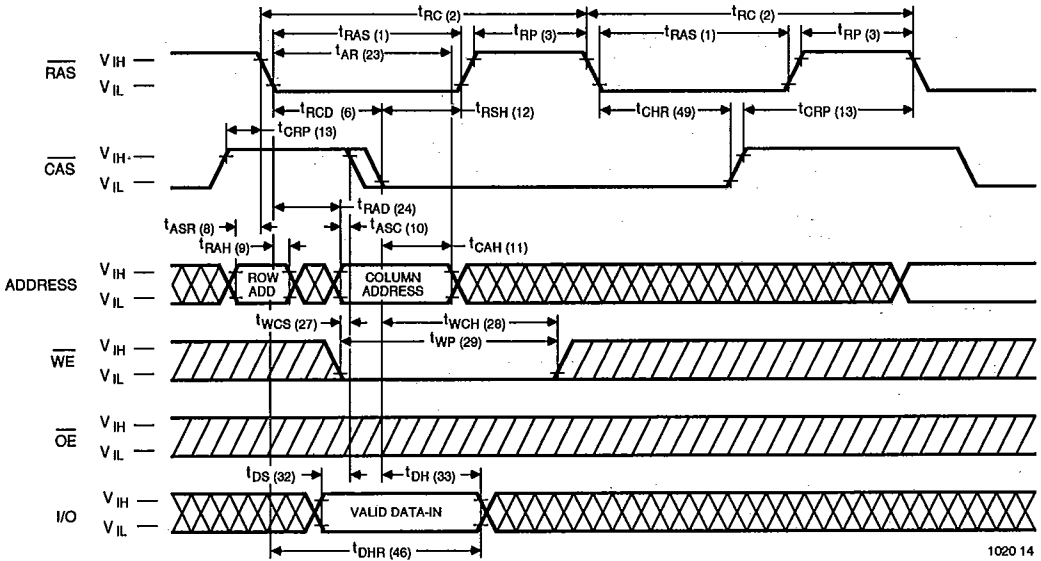

MOSEL-VITELIC

V53C464A

Waveforms of $\overline{\text{CAS}}$ -before- $\overline{\text{RAS}}$ Refresh Counter Test Cycle

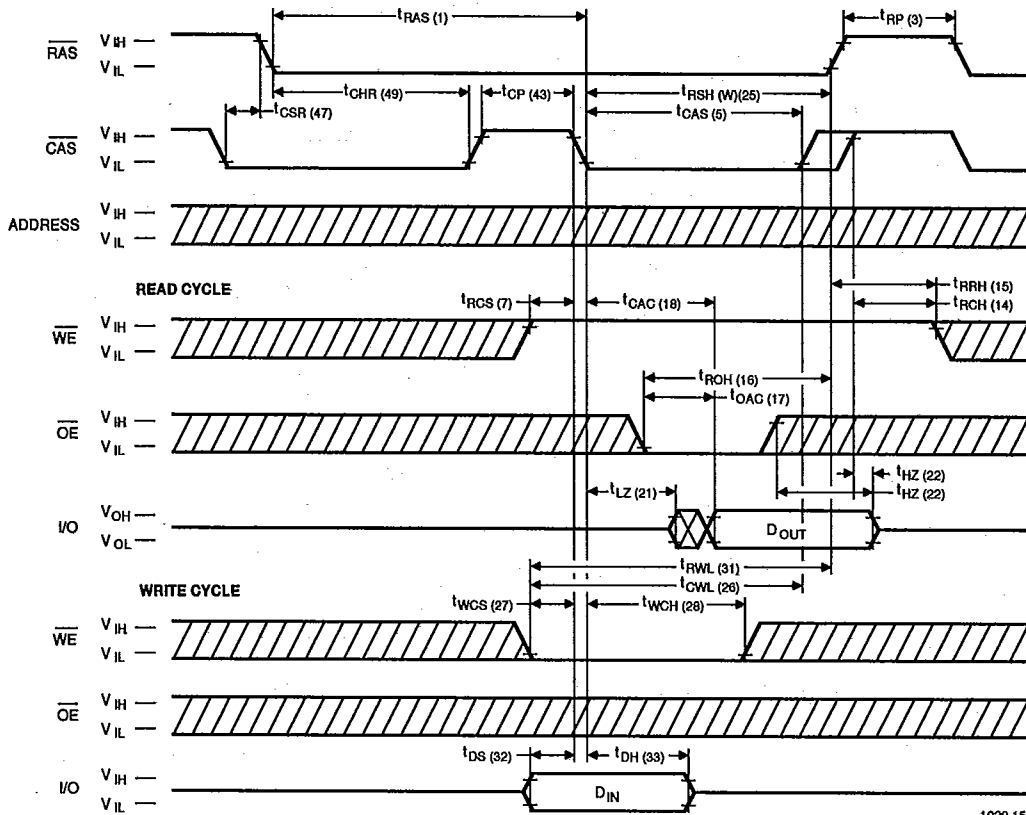

MOSEL-VITELIC**V53C464A****Functional Description**

The V53C464A is a CMOS dynamic RAM optimized for high data bandwidth, low power applications. It is functionally similar to a traditional dynamic RAM. The V53C464A reads and writes data by multiplexing a 16-bit address into an 8-bit row and an 8-bit column address. The row address is latched by the Row Address Strobe ($\overline{\text{RAS}}$). The column address "flows through" an internal address buffer and is latched by the Column Address Strobe ($\overline{\text{CAS}}$). Because access time is primarily dependent on a valid column address rather than the precise time that the $\overline{\text{CAS}}$ edge occurs, the delay time from $\overline{\text{RAS}}$ to $\overline{\text{CAS}}$ has little effect on the access time.

Memory Cycle

A memory cycle is initiated by bringing $\overline{\text{RAS}}$ low. Any memory cycle, once initiated, must not be ended or aborted before the minimum t_{RAS} time has expired. This insures proper device operation and data integrity. A new cycle must not be initiated until the minimum precharge time $t_{\text{RP}}/t_{\text{CP}}$ has elapsed.

Read Cycle

A Read cycle is performed by holding the Write Enable ($\overline{\text{WE}}$) signal high during a $\overline{\text{RAS}}/\overline{\text{CAS}}$ operation. The column address must be held for a minimum specified by t_{AR} . Data Out becomes valid only when t_{OAC} , t_{RAC} , t_{CAA} and t_{CAC} are all satisfied. As a result, the access time is dependent on the timing relationships between these parameters. For example, the access time is limited by t_{CAA} when t_{RAC} , t_{CAC} and t_{OAC} are all satisfied.

Write Cycle

A Write Cycle is performed by taking $\overline{\text{WE}}$ and $\overline{\text{CAS}}$ low during a $\overline{\text{RAS}}$ operation. The column address is latched by $\overline{\text{CAS}}$. The Write Cycle can be $\overline{\text{WE}}$ -controlled or $\overline{\text{CAS}}$ -controlled, depending on whether $\overline{\text{WE}}$ or $\overline{\text{CAS}}$ falls later. Consequently, the input data must be valid at or before the falling edge of $\overline{\text{WE}}$ or $\overline{\text{CAS}}$, whichever occurs last. In the $\overline{\text{CAS}}$ -controlled Write Cycle when the leading edge of $\overline{\text{WE}}$ occurs prior to the $\overline{\text{CAS}}$ low transition, the I/O data pins will be in the High-Z state at the beginning of the Write function. Ending the Write with $\overline{\text{RAS}}$ or $\overline{\text{CAS}}$ will maintain the output in the High-Z state.

In the $\overline{\text{WE}}$ -controlled Write Cycle, $\overline{\text{OE}}$ must be in the high state, and t_{OED} must be satisfied.

Refresh Cycle

To retain data, 256 Refresh Cycles are required in each 4 ms period. There are two ways to refresh the memory:

1. By selecting each of the 256 row addresses determined by A_0 through A_7 , at least once every 4 ms. Any Read, Write, Read-Modify-Write or $\overline{\text{RAS}}$ -only cycle refreshes the addressed row.
2. Using a $\overline{\text{CAS}}$ -before- $\overline{\text{RAS}}$ Refresh Cycle. If $\overline{\text{CAS}}$ is low during the falling edge of $\overline{\text{RAS}}$, $\overline{\text{CAS}}$ -before- $\overline{\text{RAS}}$ refresh is activated. The V53C464A will use the output of an internal 8-bit counter as the source of row addresses and ignore external address inputs.

$\overline{\text{CAS}}$ -before- $\overline{\text{RAS}}$ is a "refresh-only" mode and no data access or device selection is allowed. Thus, the output will remain in the High-Z state during the cycle. A $\overline{\text{CAS}}$ -before- $\overline{\text{RAS}}$ counter test mode is provided to ensure reliable operation of the internal refresh counter.

Data Retention Mode

The V53C464A offers a CMOS standby mode that is entered by causing the $\overline{\text{RAS}}$ clock to swing between a valid V_{IL} and an "extra high" V_{IH} within 0.2 V of V_{DD} . While the $\overline{\text{RAS}}$ clock is at the "extra high" level, the V53C464A power consumption is reduced to the low I_{DD6} level. Overall I_{DD} consumption when operating in this mode can be calculated as follows:

$$I = \frac{(t_{\text{RC}} \times I_{\text{DD1}}) + (t_{\text{RX}} - t_{\text{RC}}) \times I_{\text{DD6}}}{t_{\text{RX}}}$$

Where t_{RC} = Refresh Cycle Time
 t_{RX} = Refresh Interval / 256

MOSEL-VITELIC

V53C464A

Fast Page Mode Operation

Fast Page Mode operation permits all 256 columns within a selected row of the device to be randomly accessed at a high data rate. Maintaining $\overline{\text{RAS}}$ low while performing successive $\overline{\text{CAS}}$ cycles retains the row address internally and eliminates the need to reapply it for each cycle. The column address buffer acts as a transparent or flow-through latch while $\overline{\text{CAS}}$ is high. Thus, access begins from the occurrence of a valid column address rather than from the falling edge of $\overline{\text{CAS}}$, eliminating t_{ASC} and t_{r} from the critical timing path. $\overline{\text{CAS}}$ latches the address into the column address buffer and acts as an output enable. During Fast Page Mode operation, Read, Write, Read-Modify-Write or Read-Write-Read cycles are possible at random addresses within a row. Following the initial entry cycle into Fast Page Mode, access is t_{CAA} or t_{CAP} controlled. If the column address is valid prior to the rising edge of $\overline{\text{CAS}}$, the access time is referenced to the $\overline{\text{CAS}}$ rising edge and is specified by t_{CAP} . If the column address is valid after the rising $\overline{\text{CAS}}$ edge, access is timed from the occurrence of a valid address and is specified by t_{CAA} . In both cases, the falling edge of $\overline{\text{CAS}}$ latches the address and enables the output.

Fast Page Mode provides a sustained data rate of over 19 MHz for applications that require high data rates such as bit-mapped graphics or high-speed signal processing. The following equation can be used to calculate the maximum data rate:

$$\text{Data Rate} = \frac{256}{t_{\text{RC}} + 255 \times t_{\text{PC}}}$$

Data Output Operation

The V53C464A Input/Output is controlled by $\overline{\text{OE}}$, $\overline{\text{CAS}}$, $\overline{\text{WE}}$ and $\overline{\text{RAS}}$. A $\overline{\text{RAS}}$ low transition enables the transfer of data to and from the selected row address in the Memory Array. A $\overline{\text{RAS}}$ high transition disables data transfer and latches the output data if the output is enabled. After a memory cycle is initiated with a $\overline{\text{RAS}}$ low transition, a $\overline{\text{CAS}}$ low transition or $\overline{\text{CAS}}$ low level enables the internal I/O path. A $\overline{\text{CAS}}$ high transition or a $\overline{\text{CAS}}$ high level disables the I/O path and the output driver if it is enabled. A $\overline{\text{CAS}}$ low transition while $\overline{\text{RAS}}$ is high has no effect on the I/O data path or on the output drivers. The output drivers, when otherwise enabled, can be disabled by holding $\overline{\text{OE}}$ high. The $\overline{\text{OE}}$ signal has no

effect on any data stored in the output latches. A $\overline{\text{WE}}$ low level can also disable the output drivers when $\overline{\text{CAS}}$ is low. During a Write cycle, if $\overline{\text{WE}}$ goes low at a time in relationship to $\overline{\text{CAS}}$ that would normally cause the outputs to be active, it is necessary to use $\overline{\text{OE}}$ to disable the output drivers prior to the $\overline{\text{WE}}$ low transition to allow Data In Setup Time (t_{DS}) to be satisfied.

Power-On

After application of the V_{DD} supply, an initial pause of 200 μs is required, followed by a minimum of 8 initialization cycles (any combination of cycles containing a $\overline{\text{RAS}}$ clock). Eight initialization cycles are required after extended periods of bias without clocks (greater than the Refresh Interval).

During Power-On, the V_{DD} current requirement of the V53C464A is dependent on the input levels of $\overline{\text{RAS}}$ and $\overline{\text{CAS}}$. If $\overline{\text{RAS}}$ is low during Power-On, the device will go into an active cycle, and I_{DD} will exhibit current transients. It is recommended that $\overline{\text{RAS}}$ and $\overline{\text{CAS}}$ track with V_{DD} or be held at a valid V_{IH} during Power-On to avoid current surges.

Table 1. V53C464A Data Output Operation for Various Cycle Types

Cycle Type	I/O State
Read Cycles	Data from Addressed Memory Cell
$\overline{\text{CAS}}$ -Controlled Write Cycle (Early Write)	High-Z
$\overline{\text{WE}}$ -Controlled Write Cycle (Late Write)	$\overline{\text{OE}}$ Controlled. High $\overline{\text{OE}}$ = High-Z I/Os
Read-Modify-Write Cycles	Data from Addressed Memory Cell
Fast Page Mode Read Cycle	Data from Addressed Memory Cell
Fast Page Mode Write Cycle (Early Write)	High-Z
Fast Page Mode Read-Modify-Write Cycle	Data from Addressed Memory Cell
$\overline{\text{RAS}}$ -only Refresh	High-Z
$\overline{\text{CAS}}$ -before- $\overline{\text{RAS}}$ Refresh Cycle	Data remains as in previous cycle
$\overline{\text{CAS}}$ -only Cycles	High-Z