

TOSHIBA TRANSISTOR SILOCON NPN EPITAXIAL TYPE (PCT PROCESS)

2SC2240

LOW NOISE AUDIO AMPLIFIER APPLICATIONS

Unit in mm

The 2SC2240 is a transistor for low frequency and low noise applications. This device is designed to lower noise figure in the region of low signal source impedance, and to lower the pulse noise. This is recommended for the first stages of Equalizer amplifiers.

- Low Noise
: NF = 4dB (Typ.) $R_G = 100\Omega$, $V_{CE} = 6V$, $I_C = 100\mu A$, $f = 1kHz$
: NF = 0.5dB (Typ.) $R_G = 1k\Omega$, $V_{CE} = 6V$, $I_C = 100\mu A$, $f = 1kHz$
- Low Pulse Noise : Low 1/f Noise
- High DC Current Gain : $h_{FE} = 200 \sim 700$
- High Breakdown Voltage : $V_{CEO} = 120V$

MAXIMUM RATINGS (Ta = 25°C)

CHARACTERISTIC	SYMBOL	RATING	UNIT
Collector-Base Voltage	V_{CBO}	120	V
Collector-Emitter Voltage	V_{CEO}	120	V
Emitter-Base Voltage	V_{EBO}	5	V
Collector Current	I_C	100	mA
Base Current	I_B	20	mA
Collector Power Dissipation	P_C	300	mW
Junction Temperature	T_j	125	°C
Storage Temperature Range	T_{stg}	-55~125	°C

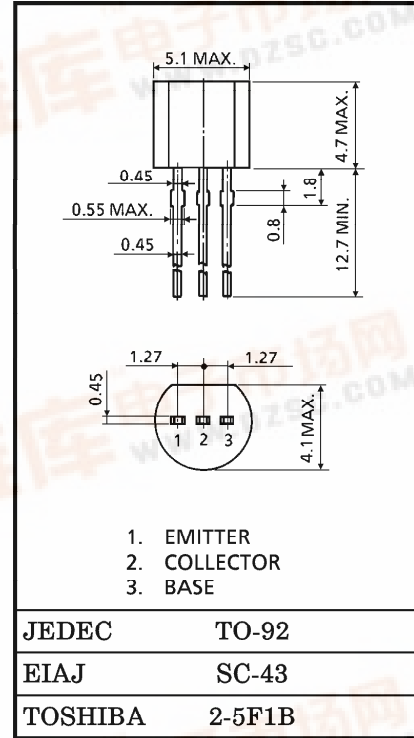

Weight : 0.21g

ELECTRICAL CHARACTERISTICS (Ta = 25°C)

CHARACTERISTIC	SYMBOL	TEST CONDITION	MIN.	TYP.	MAX.	UNIT
Collector Cut-off Current	I_{CBO}	$V_{CB} = 120V$, $I_E = 0$	—	—	0.1	μA
Emitter Cut-off Current	I_{EBO}	$V_{EB} = 5V$, $I_C = 0$	—	—	0.1	μA
Collector-Emitter Breakdown Voltage	$V_{(BR)CEO}$	$I_C = 1mA$, $I_B = 0$	120	—	—	V
DC Current Gain	h_{FE} (Note)	$V_{CE} = 6V$, $I_C = 2mA$	200	—	700	
Collector-Emitter Saturation Voltage	$V_{CE(sat)}$	$I_C = 10mA$, $I_B = 1mA$	—	—	0.3	V
Base-Emitter Voltage	V_{BE}	$V_{CE} = 6V$, $I_C = 2mA$	—	0.65	—	V
Transition Frequency	f_T	$V_{CE} = 6V$, $I_C = 1mA$	—	100	—	MHz
Collector Output Capacitance	C_{ob}	$V_{CB} = 10V$, $I_E = 0$, $f = 1MHz$	—	3.0	—	pF
Noise Figure	NF	$V_{CE} = 6V$, $I_C = 0.1mA$, $f = 10Hz$, $R_G = 10k\Omega$	—	—	6	dB
		$V_{CE} = 6V$, $I_C = 0.1mA$, $f = 1kHz$, $R_G = 10k\Omega$	—	—	2	
		$V_{CE} = 6V$, $I_C = 0.1mA$, $f = 1kHz$, $R_G = 100\Omega$	—	4	—	

Note : h_{FE} Classification GR : 200~400, BL : 350~700

961001EAA2



TOSHIBA is continually working to improve the quality and the reliability of its products. Nevertheless, semiconductor devices in general can malfunction or fail due to their inherent electrical sensitivity and vulnerability to physical stress. It is the responsibility of the buyer, when utilizing TOSHIBA products, to observe standards of safety, and to avoid situations in which a malfunction or failure of a TOSHIBA product could cause loss of human life, bodily injury or damage to property. In developing your designs, please ensure that TOSHIBA products are used within specified operating ranges as set forth in the most recent products specifications. Also, please keep in mind the precautions and conditions set forth in the TOSHIBA Semiconductor Reliability Handbook.

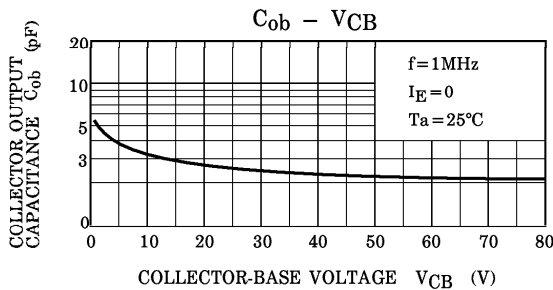
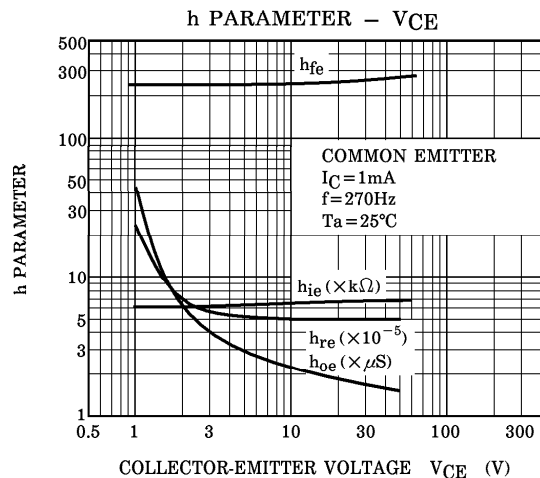
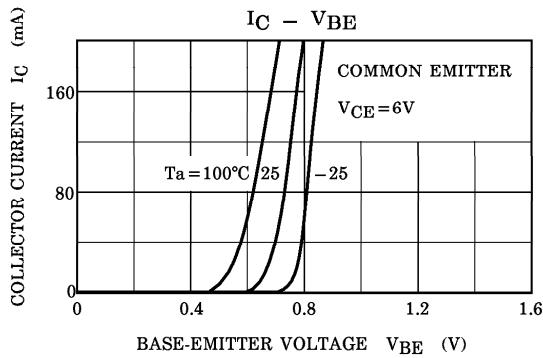
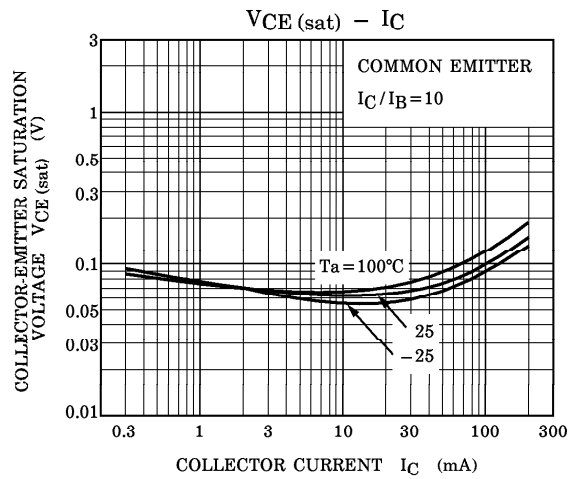
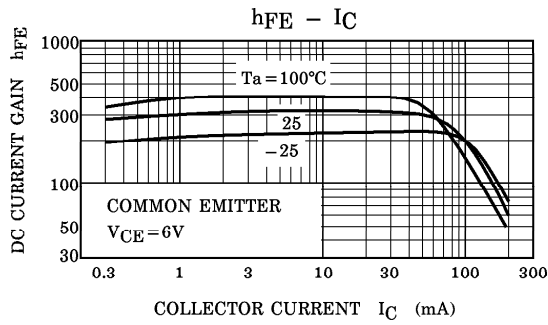
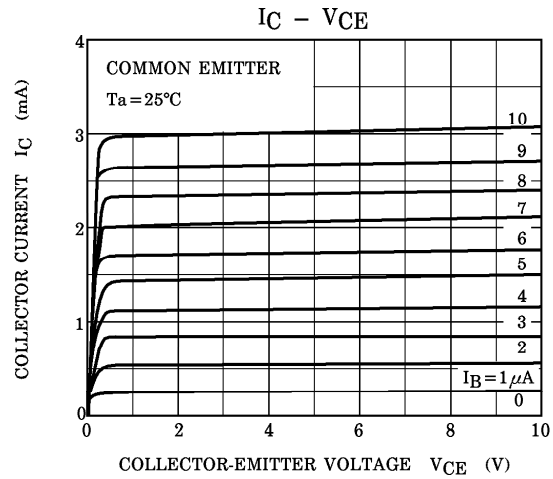
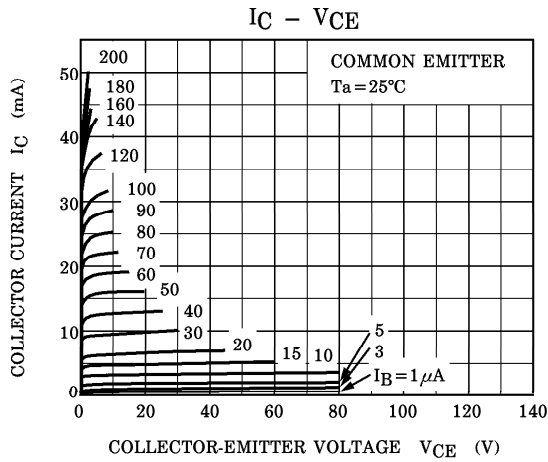

961001EAA2'

● The information contained herein is presented only as a guide for the applications of our products. No responsibility is assumed by TOSHIBA CORPORATION for any infringements of intellectual property or other rights of the third parties which may result from its use. No license is granted by implication or otherwise under any intellectual property or other rights of TOSHIBA CORPORATION or others.
● The information contained herein is subject to change without notice.

