

TOSHIBA TRANSISTOR SILICON NPN EPITAXIAL TYPE (PCT PROCESS)

2SC4935

POWER AMPLIFIER APPLICATIONS

- Good Linearity of h_{FE} .
- Complementary to 2SA1869 and 5 Watts Output Applications.

MAXIMUM RATINGS

CHARACTERISTIC		SYMBOL	RATING	UNIT
Collector-Base Voltage		V_{CBO}	50	V
Collector-Emitter Voltage		V_{CEO}	50	V
Emitter-Base Voltage		V_{EBO}	5	V
Collector Current		I_C	3	A
Base Current		I_B	0.3	A
Collector Power Dissipation	$T_a = 25^\circ\text{C}$	P_C	2.0	W
	$T_c = 25^\circ\text{C}$		10	
Junction Temperature		T_j	150	$^\circ\text{C}$
Storage Temperature Range		T_{stg}	-55~150	$^\circ\text{C}$

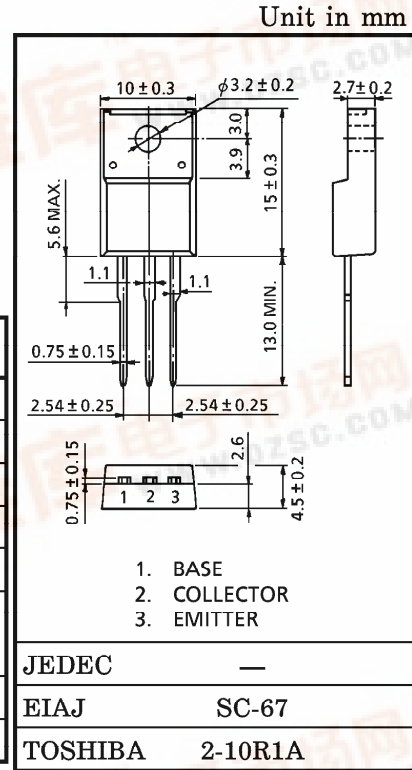

Weight : 1.7g

ELECTRICAL CHARACTERISTICS ($T_a = 25^\circ\text{C}$)

CHARACTERISTIC	SYMBOL	TEST CONDITION	MIN.	TYP.	MAX.	UNIT
Collector Cut-off Current	I_{CBO}	$V_{CB} = 50\text{V}, I_E = 0$	—	—	1.0	μA
Emitter Cut-off Current	I_{EBO}	$V_{EB} = 5\text{V}, I_C = 0$	—	—	1.0	μA
Collector-Emitter Breakdown Voltage	$V_{(BR) CEO}$	$I_C = 10\text{mA}, I_B = 0$	50	—	—	V
DC Current Gain	$h_{FE} (1)$ (Note)	$V_{CE} = 2\text{V}, I_C = 0.5\text{A}$	70	—	240	V
	$h_{FE} (2)$	$V_{CE} = 2\text{V}, I_C = 2.5\text{A}$	30	—	—	
Collector-Emitter Saturation Voltage	$V_{CE (sat)}$	$I_C = 2\text{A}, I_B = 0.2\text{A}$	—	0.4	0.6	V
Base-Emitter Voltage	V_{BE}	$V_{CE} = 2\text{V}, I_C = 0.5\text{A}$	—	0.75	1.0	V
Transition Frequency	f_T	$V_{CE} = 2\text{V}, I_C = 0.5\text{A}$	—	80	—	MHz
Collector Output Capacitance	C_{ob}	$V_{CB} = 10\text{V}, I_E = 0, f = 1\text{MHz}$	—	30	—	pF

Note : $h_{FE} (1)$ Classification O : 70~140, Y : 120~240

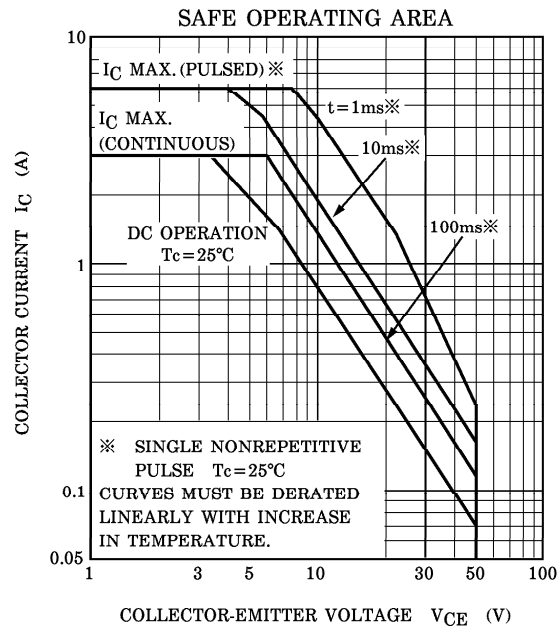
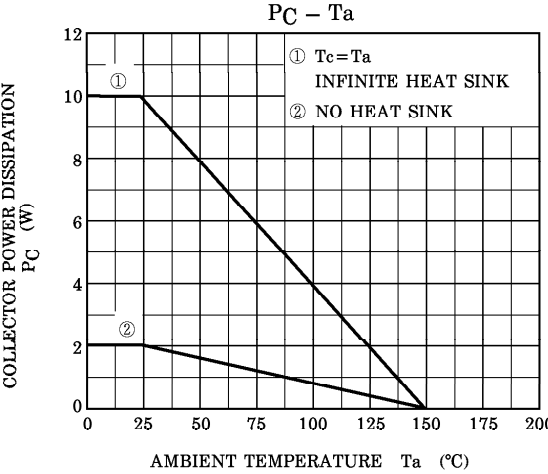
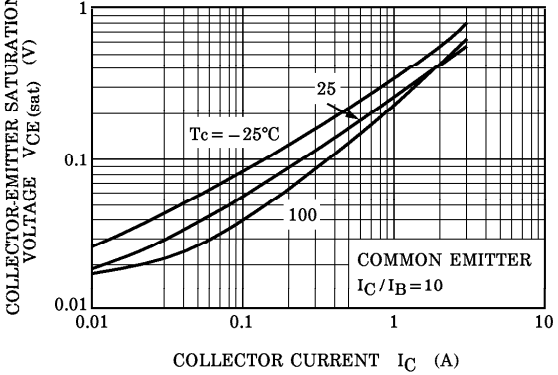
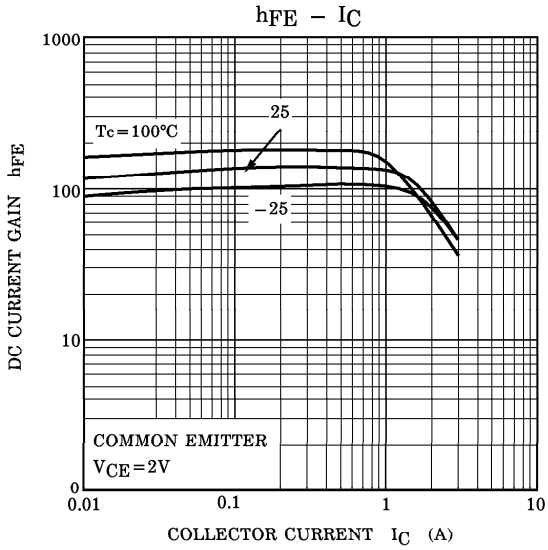
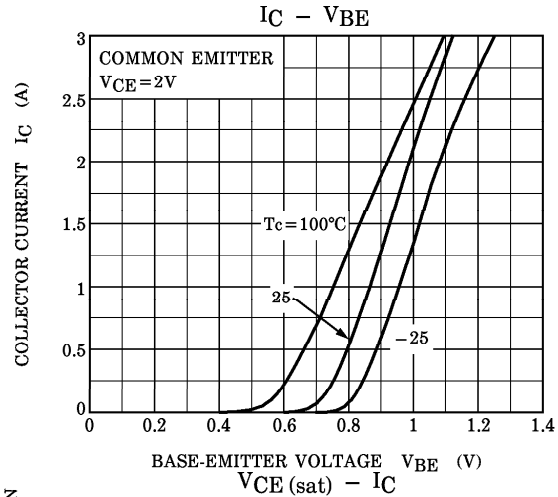
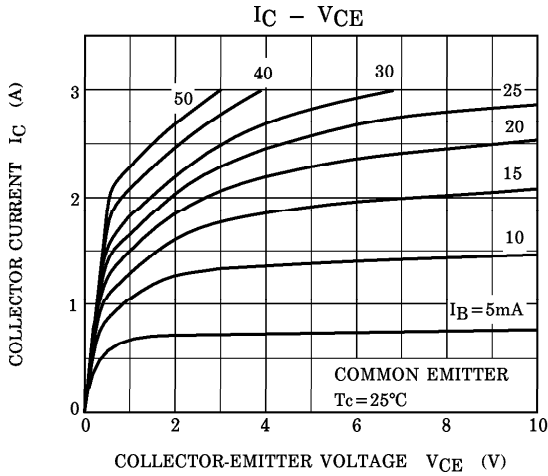

● The information contained herein is presented only as a guide for the applications of our products. No responsibility is assumed by TOSHIBA CORPORATION for any infringements of intellectual property or other rights of the third parties which may result from its use. No license is granted by implication or otherwise under any intellectual property or other rights of TOSHIBA CORPORATION or others.
 ● The information contained herein is subject to change without notice.