



CY7C266

8Kx8 Power-Switched and Reprogrammable PROM

Features

- CMOS for optimum speed/power
- Windowed for reprogrammability
- High speed
 - 20 ns (commercial)
 - 25 ns (military)
- Low power
 - 660 mW (commercial)
 - 770 mW (military)
- Super low standby power
 - Less than 85 mW when deselected
- EPROM technology 100% programmable
- 5V $\pm 10\%$ V_{CC}, commercial and military
- TTL-compatible I/O
- Direct replacement for 27C64 EPROMs

Functional Description

The CY7C266 is a high-performance 8192 word by 8 bit CMOS PROM. When deselected, the CY7C266 automatically powers down into a low-power standby mode. It is packaged in a 600-mil-wide package. The reprogrammable packages are equipped with an erasure window; when exposed to UV light, these PROMs are erased and can then be reprogrammed. The memory cells utilize proven EPROM floating-gate technology and byte-wide intelligent programming algorithms.

The CY7C266 is a plug-in replacement for EPROM devices. The EPROM cell requires only 12.5V for the super voltage and low-current requirements allow for gang programming. The EPROM cells allow for each memory location to be tested 100%, as each location is written into, erased, and repeatedly exercised prior to encapsulation. Each PROM is also tested for AC performance to guarantee that after customer programming, the product will meet DC and AC specification limits.

Reading is accomplished by placing an active LOW signal on OE and CE. The contents of the memory location addressed by the address lines (A₀ through A₁₂) will become available on the output lines (O₀ through O₇).

Logic Block Diagram

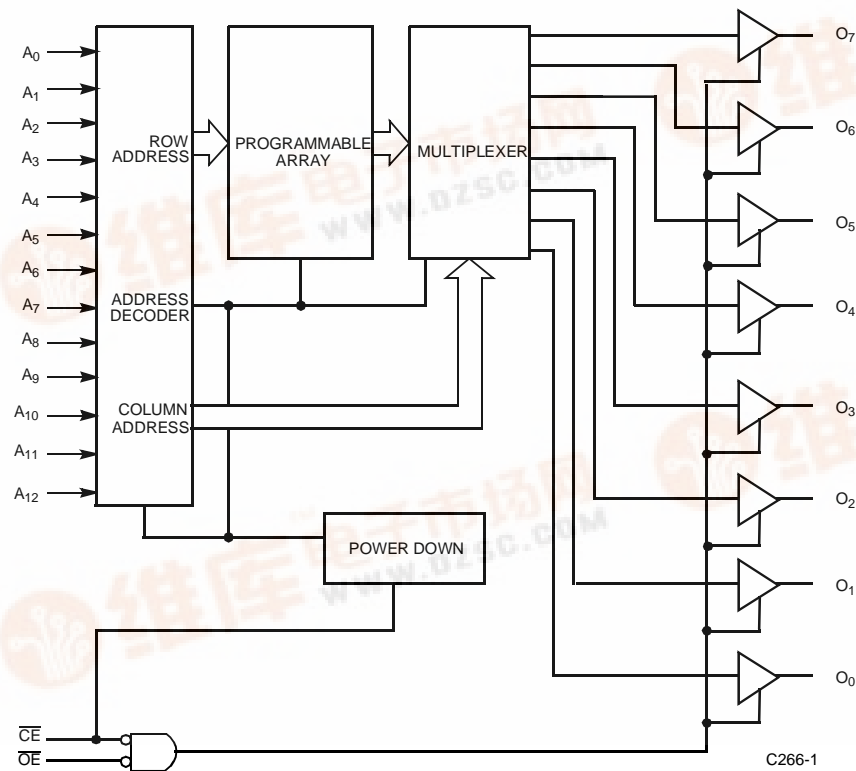

Pin Configurations

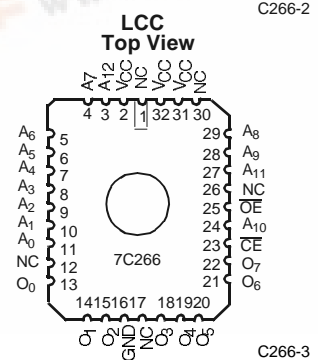
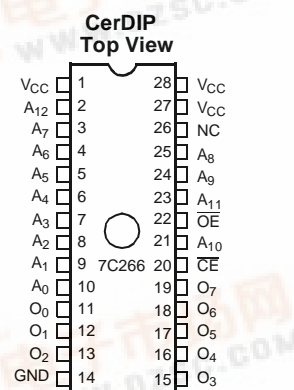



Selection Guide

		7C266-20	7C266-25	7C266-35	7C266-45
Maximum Access Time (ns)		20	25	35	45
Maximum Operating Current (mA)	Commercial	120	120	100	100
	Military		140		120
Maximum Standby Current (mA)	Commercial	15	15	15	15
	Military		15		15

Maximum Ratings

(Above which the useful life may be impaired. For user guidelines, not tested.)

Storage Temperature -65°C to +150°C

Ambient Temperature with Power Applied -55°C to +125°C

Supply Voltage to Ground Potential (Pin 28 to Pin 14) -0.5V to +7.0V

DC Voltage Applied to Outputs in High Z State -0.5V to +7.0V

DC Input Voltage -3.0V to +7.0V

DC Program Voltage 13.0V

Static Discharge Voltage > 2001V (per MIL-STD-883, Method 3015)

Latch-Up Current > 200 mA

UV Exposure 7258 Wsec/cm²

Operating Range

Range	Ambient Temperature	V _{CC}
Commercial	0°C to +70°C	5V ± 10%
Industrial ^[1]	-40°C to +85°C	5V ± 10%
Military ^[2]	-55°C to +125°C	5V ± 10%

Notes:

- Contact a Cypress representative regarding industrial temperature range specification.
- T_A is the "instant on" case temperature.

Electrical Characteristics Over the Operating Range^[3,4]

Parameter	Description	Test Conditions	7C266-20		7C266-25		Unit
			Min.	Max.	Min.	Max.	
V _{OH}	Output HIGH Voltage	V _{CC} = Min., I _{OH} = -2.0 mA	2.4		2.4		V
V _{OL}	Output LOW Voltage	V _{CC} = Min., I _{OL} = 8.0 mA		0.4		0.4	V
		V _{CC} = Min., I _{OL} = 6.0 mA				0.4	
V _{IH}	Input HIGH Voltage		2.0		2.0		V
V _{IL}	Input LOW Voltage			0.8		0.8	V
I _{IX}	Input Current	GND ≤ V _{IN} ≤ V _{CC}	-10	+10	-10	+10	μA
V _{CD}	Input Diode Clamp Voltage		Note 5				
I _{OZ}	Output Leakage Current	V _{OL} ≤ V _{OUT} ≤ V _{OH} , Output Disabled	-40	+40	-40	+40	μA
I _{OS}	Output Short Circuit Current ^[5]	V _{CC} = Max., V _{OUT} = GND	-20	-90	-20	-90	mA
I _{CC}	Power Supply Current	V _{CC} = Max., V _{IN} = 2.0V, I _{OUT} = 0 mA	Com'l	120		120	mA
			Mil			140	
I _{SB}	Standby Supply Current	Chip Enable Inactive, CE ≥ V _{IH} , I _{OUT} = 0 mA	Com'l	15		15	mA
			Mil			15	

Notes:

- See the last page of this specification for Group A subgroup testing information.
- See the "Introduction to CMOS PROMs" section of the Cypress Data Book for general information on testing.
- For test purposes, not more than one output at a time should be shorted. Short circuit test duration should not exceed 30 seconds.



Electrical Characteristics Over the Operating Range^[3,4] (Continued)

Parameter	Description	Test Conditions	7C266-35		7C266-45		Unit
			Min.	Max.	Min.	Max.	
V _{OH}	Output HIGH Voltage	V _{CC} = Min., I _{OH} = -4.0 mA	2.4		2.4		V
V _{OL}	Output LOW Voltage	V _{CC} = Min., I _{OL} = 16.0 mA		0.4		0.4	V
V _{IH}	Input HIGH Voltage		2.0		2.0		V
V _{IL}	Input LOW Voltage			0.8		0.8	V
I _{IX}	Input Current	GND ≤ V _{IN} ≤ V _{CC}	-10	+10	-10	+10	μA
V _{CD}	Input Diode Clamp Voltage		Note 5				
I _{OZ}	Output Leakage Current	V _{OL} ≤ V _{OUT} ≤ V _{OH} , Output Disabled	-10	+10	-10	+10	μA
I _{OS}	Output Short Circuit Current ^[5]	V _{CC} = Max., V _{OUT} = GND	-20	-90	-20	-90	mA
I _{CC}	Power Supply Current	V _{CC} = Max., V _{IN} = 2.0V, I _{OUT} = 0 mA	Com'l	100		100	mA
			Mil			120	
I _{SB}	Standby Supply Current	Chip Enable Inactive, CE ≥ V _{IH} , I _{OUT} = 0 mA	Com'l	15		15	mA
			Mil			15	

Capacitance^[4]

Parameter	Description	Test Conditions	Max.	Unit
C _{IN}	Input Capacitance	T _A = 25°C, f = 1 MHz, V _{CC} = 5.0V	10	pF
C _{OUT}	Output Capacitance		10	pF

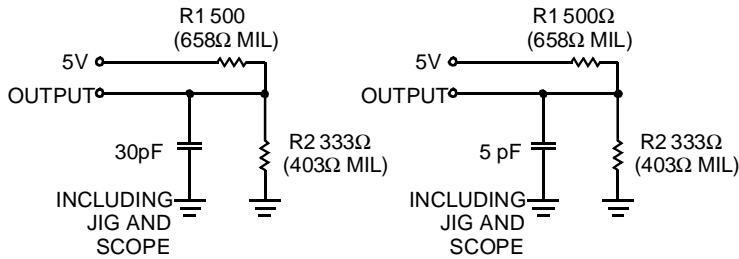
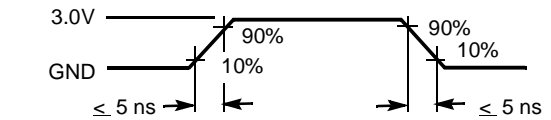
AC Test Loads and Waveforms
Test Load for – 20 through – 25 speeds

(a) Normal Load
(b) High Z Load

C266-5

C266-4

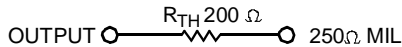
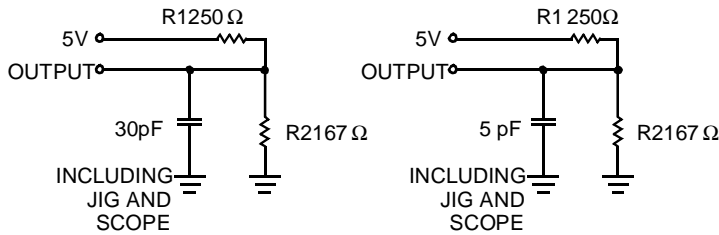
Equivalent to: THÉVENIN EQUIVALENT

Test Load for –35 through –55 speeds

(c) Normal Load
(d) High Z Load

C266-6

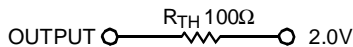
Equivalent to: THÉVENIN EQUIVALENT

Switching Characteristics Over the Operating Range^[2,3,4]

Parameter	Description	7C266-20		7C266-25		7C266-35		7C266-45		Unit
		Min.	Max.	Min.	Max.	Min.	Max.	Min.	Max.	
t_{AA}	Address to Output Valid		20		25		35		45	ns
t_{HZCE}	Chip Enable Inactive to High Z		25		30		40		45	ns
t_{HZOE}	Output Enable Inactive to High Z		12		12		20		20	ns
t_{AOE}	Output Enable Active to Output Valid		12		12		20		20	ns
t_{ACE}	Chip Enable Active to Output Valid		25		30		40		45	ns
t_{OHA}	Data Hold from Address Change	3		3		3		3		ns
t_{PU}	Chip Enable Active to Power-Up		25		30		40		45	ns
t_{PD}	Chip Enable Inactive to Power-Down		25		30		40		45	ns

Erasure Characteristics

Wavelengths of light less than 4000 angstroms begin to erase the devices in the windowed package. For this reason, an opaque label should be placed over the window if the EPROM

is exposed to sunlight or fluorescent lighting for extended periods of time.

The recommended dose of ultraviolet light for erasure is a wavelength of 2537 angstroms for a minimum dose (UV intensity multiplied by exposure time) of 25 Wsec/cm². For an ultraviolet lamp with a 12 mW/cm² power rating, the exposure time would

be approximately 35 minutes. The CY7C266 needs to be within 1 inch of the lamp during erasure. Permanent damage may result if the EPROM is exposed to high-intensity UV light for an extended period of time.

7258 Wsec/cm² is the recommended maximum dosage.

Programming Modes

Programming support is available from Cypress as well as from a number of third party software vendors. For detailed programming information, including a listing of software packages, please see the PROM Programming Information located at the end of this section. Programming algorithms can be obtained from any Cypress representative.

Table 1. Mode Selection

Mode	Pin Function ^[6, 7]								
	Normal Operation	A ₈	A ₉	A ₁₀	A ₁₁	A ₁₂	CE	OE	D ₇ - D ₀
Program		VFY	PGM	LAT	NA	NA	CE	V _{PP}	D ₇ - D ₀
Read		A ₈	A ₉	A ₁₀	A ₁₁	A ₁₂	V _{IL}	V _{IL}	O ₇ - O ₀
Standby		X	X	X	X	X	V _{IH}	X	Three-Stated
Output Disable		A ₈	A ₉	A ₁₀	A ₁₁	A ₁₂	V _{IL}	V _{IH}	Three-Stated
Program		V _{IHP}	V _{ILP}	V _{ILP}	V _{ILP}	V _{ILP}	V _{ILP}	V _{PP}	D ₇ - D ₀
Program Verify		V _{ILP}	V _{IHP}	V _{ILP}	V _{ILP}	V _{ILP}	V _{ILP}	V _{PP}	O ₇ - O ₀
Program Inhibit		V _{IHP}	V _{IHP}	V _{ILP}	V _{ILP}	V _{ILP}	V _{ILP}	V _{PP}	Three-Stated
Blank Check		V _{ILP}	V _{IHP}	V _{ILP}	V _{ILP}	V _{ILP}	V _{ILP}	V _{PP}	O ₇ - O ₀

Notes:

- 6. X = "don't care" but must not exceed V_{CC} + 5%.
- 7. Address A₈ - A₁₂ must be latched through lines A₀ - A₄ in Programming modes.

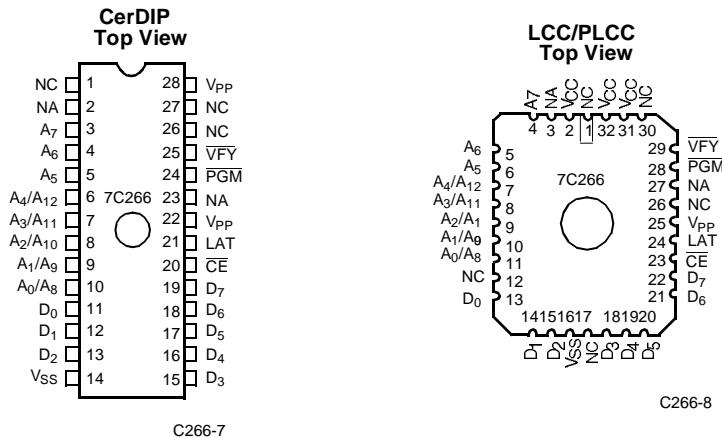
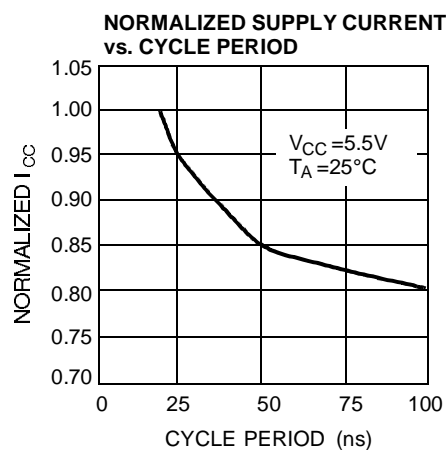
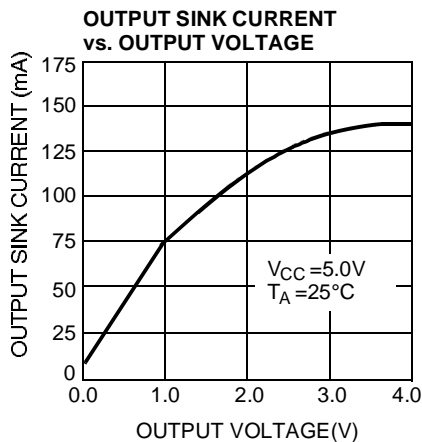
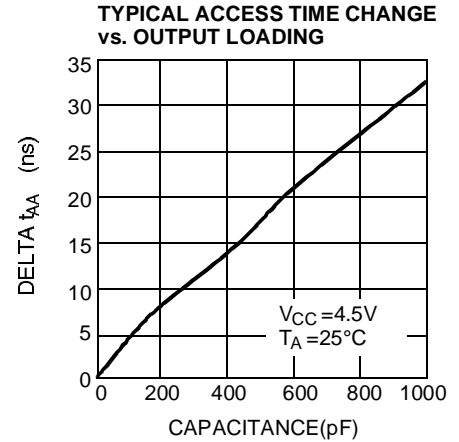
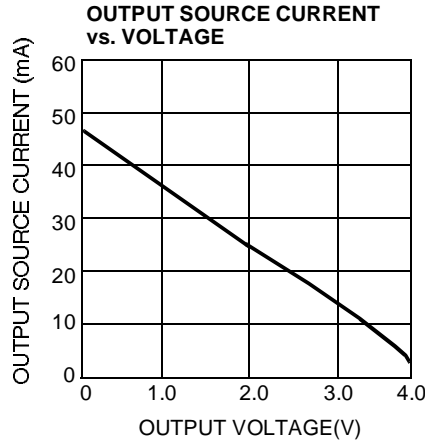
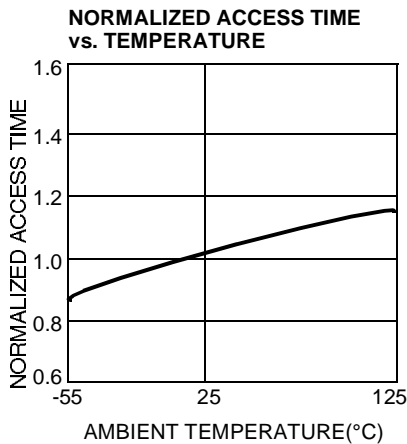
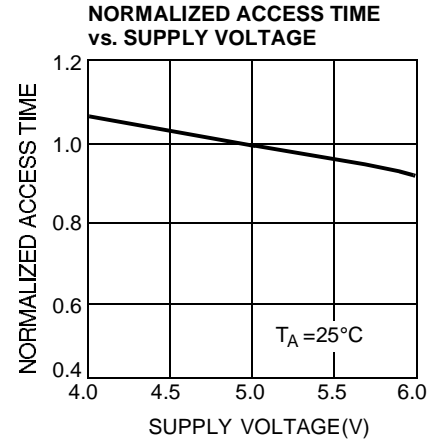
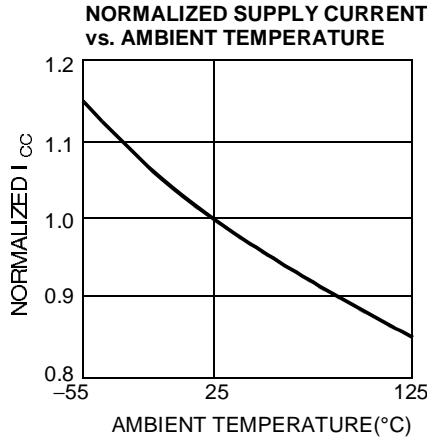
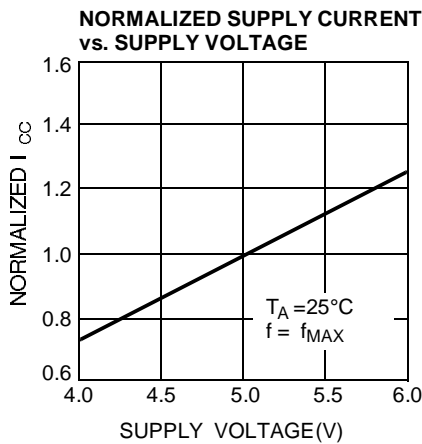

Figure 1. Programming Pinout

Typical DC and AC Characteristics



Ordering Information^[8]

Speed (ns)	Ordering Code	Package Name	Package Type	Operating Range
20	CY7C266-20PC	P15	28-Lead (600-Mil) Molded DIP	Commercial
	CY7C266-20WC	W16	28-Lead (600-Mil) Windowed CerDIP	
25	CY7C266-25PC	P15	28-Lead (600-Mil) Molded DIP	Commercial
	CY7C266-25WC	W16	28-Lead (600-Mil) Windowed CerDIP	
	CY7C266-25DMB	D16	28-Lead (600-Mil) CerDIP	Military
	CY7C266-25LMB	L55	32-Pin Rectangular Leadless Chip Carrier	
	CY7C266-25QMB	Q55	32-Pin Windowed Rectangular Leadless Chip Carrier	
	CY7C266-25WMB	W16	28-Lead (600-Mil) Windowed CerDIP	
35	CY7C266-35PC	P15	28-Lead (600-Mil) Molded DIP	Commercial
	CY7C266-35WC	W16	28-Lead (600-Mil) Windowed CerDIP	
45	CY7C266-45PC	P15	28-Lead (600-Mil) Molded DIP	Commercial
	CY7C266-45WC	W16	28-Lead (600-Mil) Windowed CerDIP	
	CY7C266-45DMB	D16	28-Lead (600-Mil) CerDIP	Military
	CY7C266-45LMB	L55	32-Pin Rectangular Leadless Chip Carrier	
	CY7C266-45QMB	Q55	32-Pin Windowed Rectangular Leadless Chip Carrier	
	CY7C266-45WMB	W16	28-Lead (600-Mil) Windowed CerDIP	

Note:

8. Most of these products are available in industrial temperature range. Contact a Cypress representative for specifications and product availability.

**MILITARY SPECIFICATIONS
Group A Subgroup Testing**
DC Characteristics

Parameter	Subgroups
V _{OH}	1, 2, 3
V _{OL}	1, 2, 3
V _{IH}	1, 2, 3
V _{IL}	1, 2, 3
I _{Ix}	1, 2, 3
I _{Oz}	1, 2, 3

DC Characteristics

Parameter	Subgroups
I _{CC}	1, 2, 3
I _{SB}	1, 2, 3

Switching Characteristics

Parameter	Subgroups
t _{AA}	7, 8, 9, 10, 11
t _{AOE}	7, 8, 9, 10, 11
t _{ACE}	7, 8, 9, 10, 11

Document #: 38-00086-E

Package Diagrams

28-Lead (600-Mil) CerDIP D16
MIL-STD-1835 D- 10Config.A

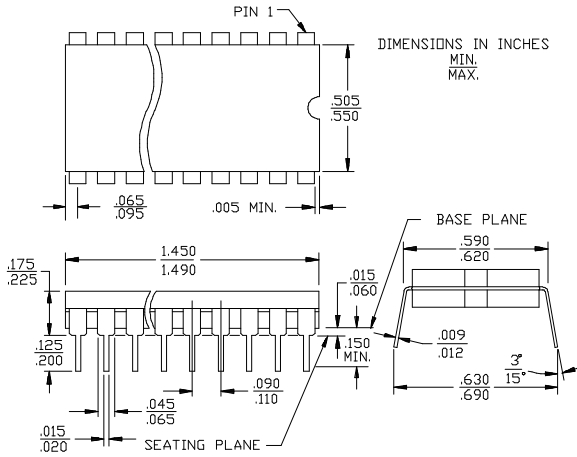

32-Pin Rectangular Leadless Chip Carrier L55
MIL-STD-1835 C-12

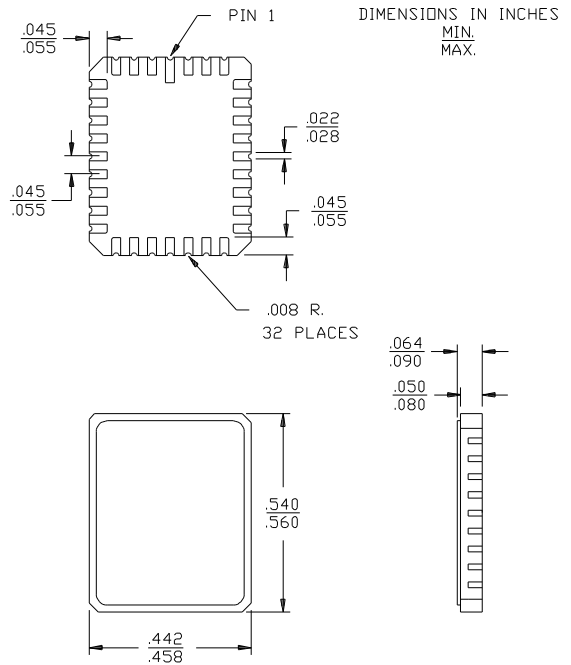

28-Lead (600-Mil) Molded DIP P15

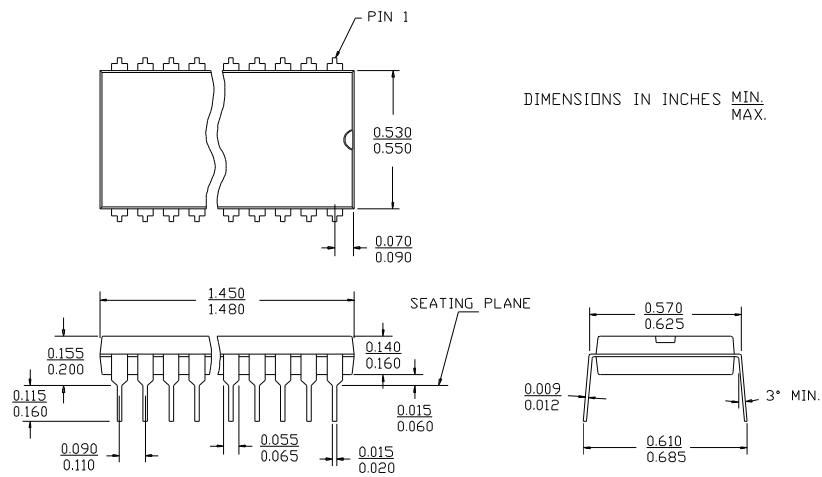

Package Diagrams (continued)

32-Pin Windowed Rectangular Leadless Chip Carrier Q55
MIL-STD-1835 C-12

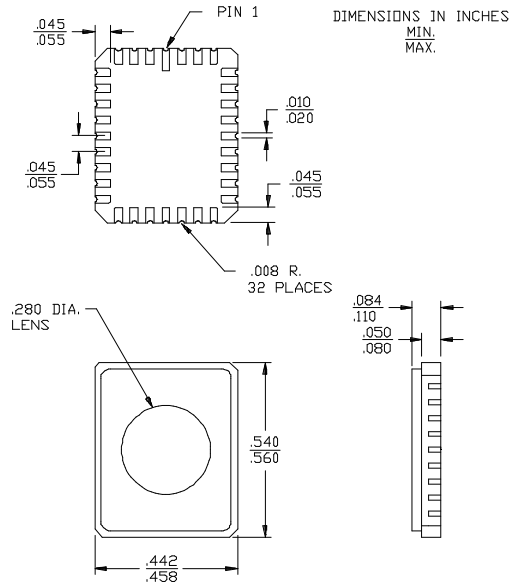

28-Lead (600-Mil) Windowed CerDIP W16
MIL-STD-1835 D-10Config.A

