

# Hybrid Power Module

## Integrated Power Stage for 2.0 hp Motor Drives

(This device is not recommended for new designs)  
(This device is replaced by MHPM7A20E60DC3)

This module integrates a 3-phase input rectifier bridge, 3-phase output inverter and brake transistor/diode in a single convenient package. The output inverter utilizes advanced insulated gate bipolar transistors (IGBT) matched with free-wheeling diodes to give optimal dynamic performance. It has been configured for use as a three-phase motor drive module or for many other power switching applications. The top connector pins have been designed for easy interfacing to the user's control board.

- Short Circuit Rated 10  $\mu$ s @ 25°C, 300V
- Pin-to-Baseplate Isolation Exceeds 2500 Vac (rms)
- Convenient Package Outline
- UL  Recognized
- Access to Positive and Negative DC Bus
- Visit our website at <http://www.mot-sps.com/tsg/>

**MHPM7B20A60A**

**20 AMP, 600 VOLT  
HYBRID POWER MODULE**

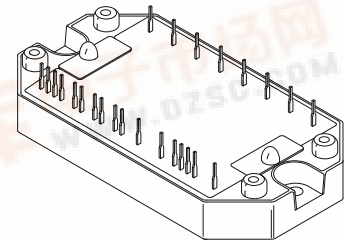

PLASTIC PACKAGE  
CASE 440-02, Style 1

### MAXIMUM DEVICE RATINGS ( $T_J = 25^\circ\text{C}$ unless otherwise noted)

Rating	Symbol	Value	Unit
<b>INPUT RECTIFIER BRIDGE</b>			
Peak Repetitive Reverse Voltage ( $T_J = 125^\circ\text{C}$ )	$V_{RRM}$	600	V
Average Output Rectified Current	$I_O$	20	A
Peak Non-repetitive Surge Current (1/2 cycle) <sup>(1)</sup>	$I_{FSM}$	240	A
<b>OUTPUT INVERTER</b>			
IGBT Reverse Voltage	$V_{CES}$	600	V
Gate-Emitter Voltage	$V_{GES}$	$\pm 20$	V
Continuous IGBT Collector Current	$I_{Cmax}$	20	A
Peak Repetitive IGBT Collector Current – (PW = 1.0 ms) <sup>(2)</sup>	$I_{C(pk)}$	40	A
Continuous Free-Wheeling Diode Current	$I_{Fmax}$	20	A
Peak Repetitive Free-Wheeling Diode Current – (PW = 1.0 ms) <sup>(2)</sup>	$I_{F(pk)}$	40	A
IGBT Power Dissipation per die ( $T_C = 95^\circ\text{C}$ )	$P_D$	78	W
Free-Wheeling Diode Power Dissipation per die ( $T_C = 95^\circ\text{C}$ )	$P_D$	39	W
Junction Temperature Range	$T_J$	-40 to +125	$^\circ\text{C}$
Short Circuit Duration ( $V_{CE} = 300\text{ V}$ , $T_J = 25^\circ\text{C}$ )	$t_{sc}$	10	$\mu\text{s}$

(1) 1 cycle = 50 or 60 Hz

(2) 1 ms = 1.0% duty cycle

## MHPM7B20A60A

### MAXIMUM DEVICE RATINGS (continued) ( $T_J = 25^\circ\text{C}$ unless otherwise noted)

Rating	Symbol	Value	Unit
<b>BRAKE CIRCUIT</b>			
IGBT Reverse Voltage	$V_{CES}$	600	V
Gate-Emitter Voltage	$V_{GES}$	$\pm 20$	V
Continuous IGBT Collector Current	$I_{Cmax}$	20	A
Peak Repetitive IGBT Collector Current <sup>(2)</sup>	$I_{C(pk)}$	40	A
IGBT Power Dissipation ( $T_C = 95^\circ\text{C}$ )	PD	78	W
Peak Repetitive Output Diode Reverse Voltage ( $T_J = 125^\circ\text{C}$ )	$V_{RRM}$	600	V
Continuous Output Diode Current	$I_{Fmax}$	20	A
Peak Output Diode Current <sup>(2)</sup>	$I_{F(pk)}$	40	A
<b>TOTAL MODULE</b>			
Isolation Voltage (47–63 Hz, 1.0 Minute Duration)	$V_{ISO}$	2500	Vac
Operating Case Temperature Range	$T_C$	-40 to +90	$^\circ\text{C}$
Storage Temperature Range	$T_{stg}$	-40 to +125	$^\circ\text{C}$
Mounting Torque	–	6.0	lb-in

### ELECTRICAL CHARACTERISTICS ( $T_J = 25^\circ\text{C}$ unless otherwise noted)

Characteristic	Symbol	Min	Typ	Max	Unit
<b>INPUT RECTIFIER BRIDGE</b>					
Reverse Leakage Current ( $V_{RRM} = 600\text{ V}$ )	$I_R$	–	5.0	50	$\mu\text{A}$
Forward Voltage ( $I_F = 20\text{ A}$ )	$V_F$	–	1.1	1.5	V
Thermal Resistance (Each Die)	$R_{\theta JC}$	–	–	2.9	$^\circ\text{C/W}$
<b>OUTPUT INVERTER</b>					
Gate-Emitter Leakage Current ( $V_{CE} = 0\text{ V}$ , $V_{GE} = \pm 20\text{ V}$ )	$I_{GES}$	–	–	$\pm 20$	$\mu\text{A}$
Collector-Emitter Leakage Current ( $V_{CE} = 600\text{ V}$ , $V_{GE} = 0\text{ V}$ ) $T_J = 25^\circ\text{C}$ $T_J = 125^\circ\text{C}$	$I_{CES}$	– –	6.0 2000	100	$\mu\text{A}$
Gate-Emitter Threshold Voltage ( $V_{CE} = V_{GE}$ , $I_C = 1.0\text{ mA}$ )	$V_{GE(th)}$	4.0	6.0	8.0	V
Collector-Emitter Breakdown Voltage ( $I_C = 10\text{ mA}$ , $V_{GE} = 0$ )	$V_{(BR)CES}$	600	–	–	V
Collector-Emitter Saturation Voltage ( $I_C = 20\text{ A}$ , $V_{GE} = 15\text{ V}$ )	$V_{CE(SAT)}$	–	2.5	3.5	V
Input Capacitance ( $V_{GE} = 0\text{ V}$ , $V_{CE} = 10\text{ V}$ , $f = 1.0\text{ MHz}$ )	$C_{ies}$	–	4400	–	pF
Input Gate Charge ( $V_{CE} = 300\text{ V}$ , $I_C = 20\text{ A}$ , $V_{GE} = 15\text{ V}$ )	$Q_T$	–	145	–	nC
Fall Time – Inductive Load ( $V_{CE} = 300\text{ V}$ , $I_C = 20\text{ A}$ , $V_{GE} = 15\text{ V}$ , $R_{G(off)} = 20\ \Omega$ )	$t_f$	–	210	500	ns
Turn-On Energy ( $V_{CE} = 300\text{ V}$ , $I_C = 20\text{ A}$ , $V_{GE} = 15\text{ V}$ , $R_{G(on)} = 47\ \Omega$ )	$E_{on}$	–	–	2.5	mJ
Turn-Off Energy ( $V_{CE} = 300\text{ V}$ , $I_C = 20\text{ A}$ , $V_{GE} = 15\text{ V}$ , $R_{G(off)} = 20\ \Omega$ )	$E_{off}$	–	–	2.5	mJ
Free Wheeling Diode Forward Voltage ( $I_F = 20\text{ A}$ , $V_{GE} = 0\text{ V}$ )	$V_F$	–	1.3	2.0	V
Free Wheeling Diode Reverse Recovery Time ( $I_F = 20\text{ A}$ , $V = 300\text{ V}$ , $di/dt = 100\text{ A}/\mu\text{s}$ )	$t_{rr}$	–	170	200	ns
Free Wheeling Diode Stored Charge ( $I_F = 20\text{ A}$ , $V = 300\text{ V}$ , $di/dt = 100\text{ A}/\mu\text{s}$ )	$Q_{rr}$	–	1060	1600	nC
Thermal Resistance – IGBT (Each Die)	$R_{\theta JC}$	–	–	1.5	$^\circ\text{C/W}$
Thermal Resistance – Free-Wheeling Diode (Each Die)	$R_{\theta JC}$	–	–	2.9	$^\circ\text{C/W}$

(2) 1.0 ms = 1.0% duty cycle

**MHPM7B20A60A****ELECTRICAL CHARACTERISTICS (continued)** ( $T_J = 25^\circ\text{C}$  unless otherwise noted)

Characteristic	Symbol	Min	Typ	Max	Unit
<b>BRAKE CIRCUIT</b>					
Gate-Emitter Leakage Current ( $V_{CE} = 0\text{ V}$ , $V_{GE} = \pm 20\text{ V}$ )	$I_{GES}$	–	–	$\pm 20$	$\mu\text{A}$
Collector-Emitter Leakage Current ( $V_{CE} = 600\text{ V}$ , $V_{GE} = 0\text{ V}$ ) $T_J = 25^\circ\text{C}$ $T_J = 125^\circ\text{C}$	$I_{CES}$	– –	6.0 2000	100 –	$\mu\text{A}$
Gate-Emitter Threshold Voltage ( $V_{CE} = V_{GE}$ , $I_C = 1.0\text{ mA}$ )	$V_{GE(th)}$	4.0	6.0	8.0	V
Collector-Emitter Breakdown Voltage ( $I_C = 10\text{ mA}$ , $V_{GE} = 0$ )	$V_{(BR)CES}$	600	–	–	V
Collector-Emitter Saturation Voltage ( $V_{GE} = 15\text{ V}$ , $I_C = 20\text{ A}$ )	$V_{CE(SAT)}$	–	2.5	3.5	V
Input Capacitance ( $V_{GE} = 0\text{ V}$ , $V_{CE} = 25\text{ V}$ , $f = 1.0\text{ MHz}$ )	$C_{ies}$	–	4400	–	pF
Input Gate Charge ( $V_{CE} = 300\text{ V}$ , $I_C = 20\text{ A}$ , $V_{GE} = 15\text{ V}$ )	$Q_T$	–	145	–	nC
Fall Time – Inductive Load ( $V_{CE} = 300\text{ V}$ , $I_C = 20\text{ A}$ , $V_{GE} = 15\text{ V}$ , $R_{G(off)} = 20\ \Omega$ )	$t_f$	–	210	500	ns
Turn-On Energy ( $V_{CE} = 300\text{ V}$ , $I_C = 20\text{ A}$ , $V_{GE} = 15\text{ V}$ , $R_{G(on)} = 47\ \Omega$ )	$E_{on}$	–	–	2.5	mJ
Turn-Off Energy ( $V_{CE} = 300\text{ V}$ , $I_C = 20\text{ A}$ , $V_{GE} = 15\text{ V}$ , $R_{G(off)} = 20\ \Omega$ )	$E_{off}$	–	–	2.5	mJ
Output Diode Forward Voltage ( $I_F = 20\text{ A}$ )	$V_F$	–	1.3	2.0	V
Output Diode Reverse Leakage Current	$I_R$	–	–	50	$\mu\text{A}$
Thermal Resistance – IGBT	$R_{\theta JC}$	–	–	1.5	$^\circ\text{C/W}$
Thermal Resistance – Output Diode	$R_{\theta JC}$	–	–	2.9	$^\circ\text{C/W}$

# MHPM7B20A60A

## Typical Characteristics

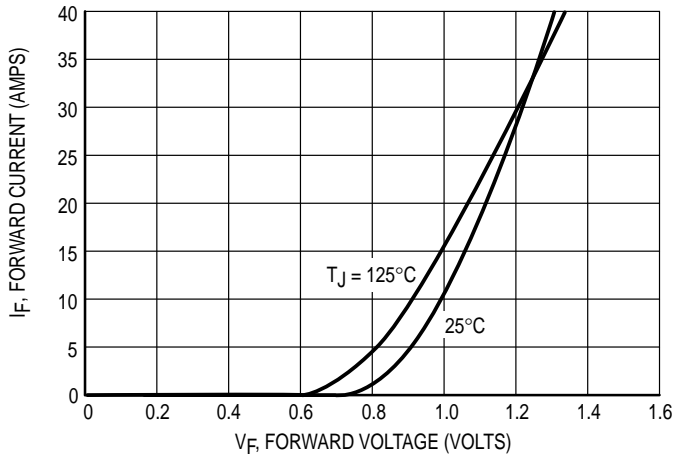

**Figure 1. Forward Characteristics — Input Rectifier**

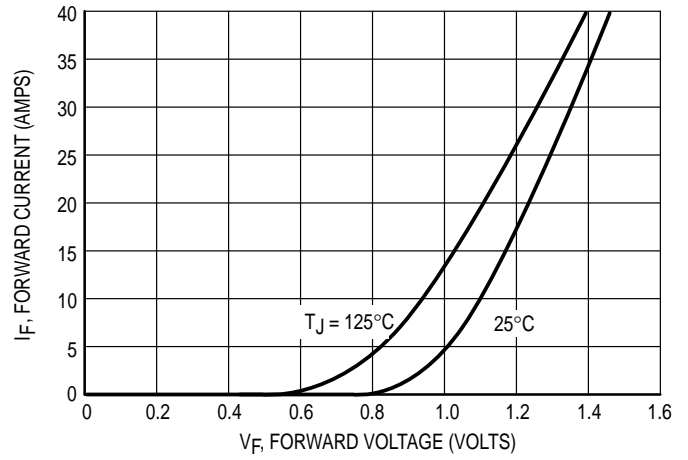

**Figure 2. Forward Characteristics — Free-Wheeling Diode**

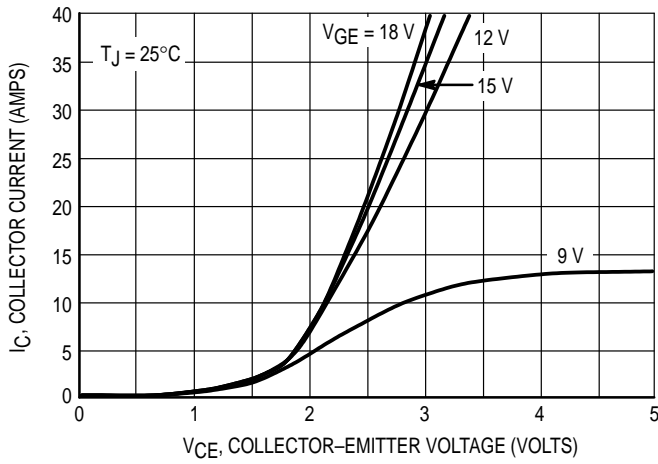

**Figure 3. Forward Characteristics,  $T_J = 25^\circ\text{C}$**

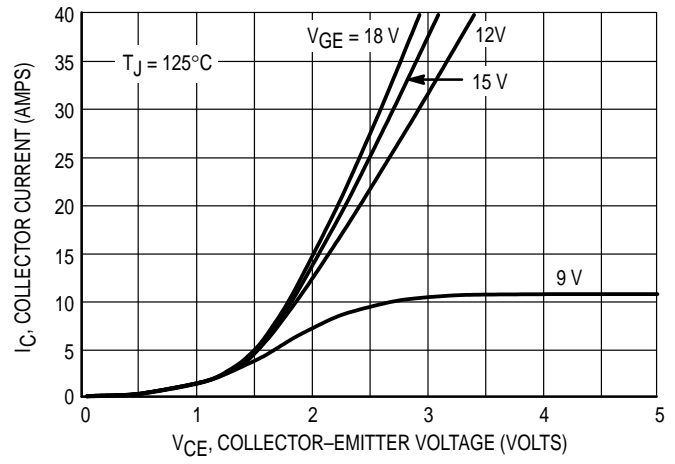

**Figure 4. Forward Characteristics,  $T_J = 125^\circ\text{C}$**

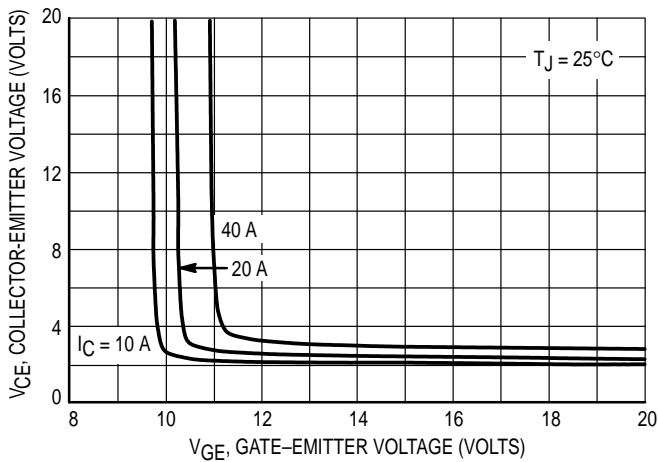

**Figure 5. Collector-Emitter Voltage versus Gate-Emitter Voltage**

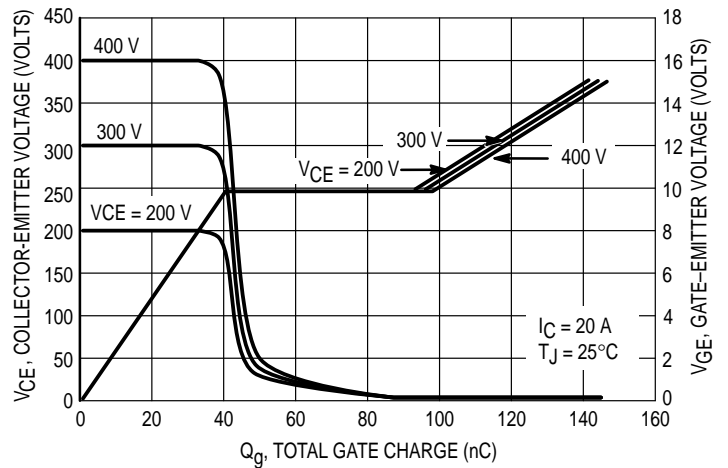

**Figure 6. Collector-Emitter and Gate-Emitter Voltages versus Total Gate Charge**

Typical Characteristics

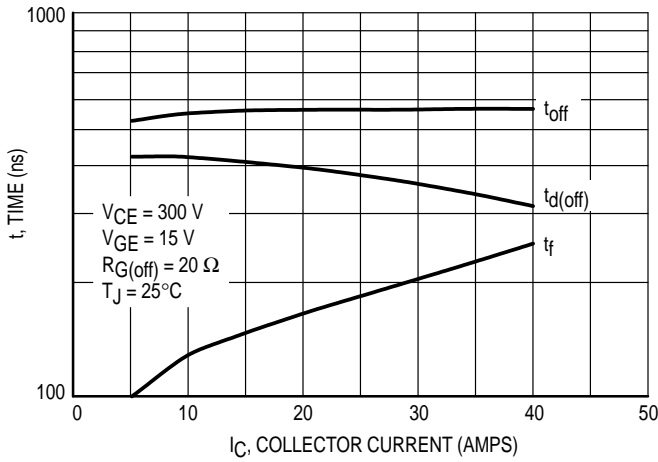

Figure 7. Inductive Switching Times versus Collector Current,  $T_J = 25^\circ\text{C}$

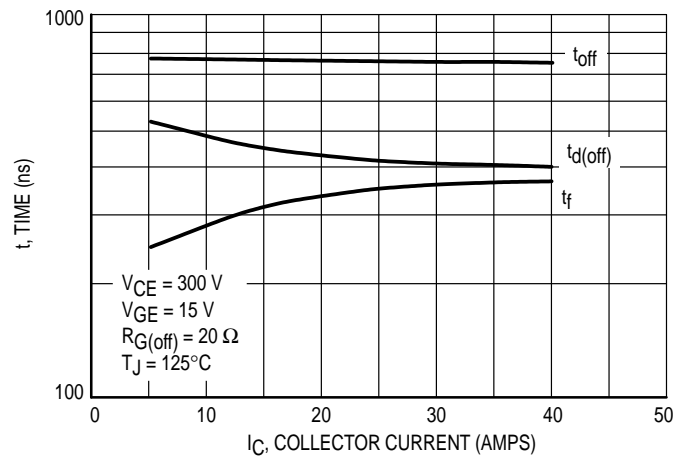

Figure 8. Inductive Switching Times versus Collector Current,  $T_J = 125^\circ\text{C}$

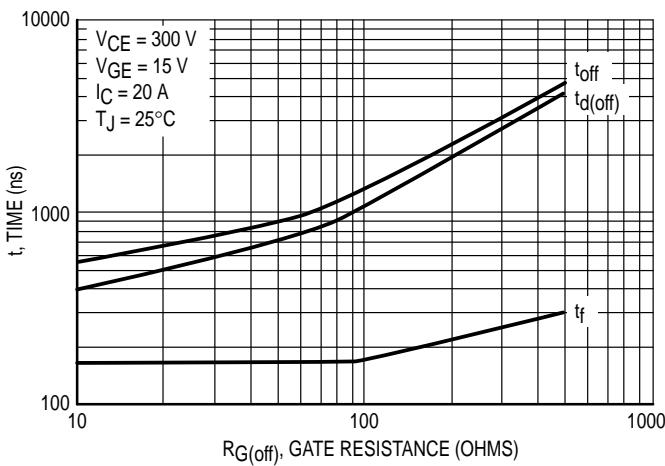

Figure 9. Inductive Switching Times versus Gate Resistance,  $T_J = 25^\circ\text{C}$

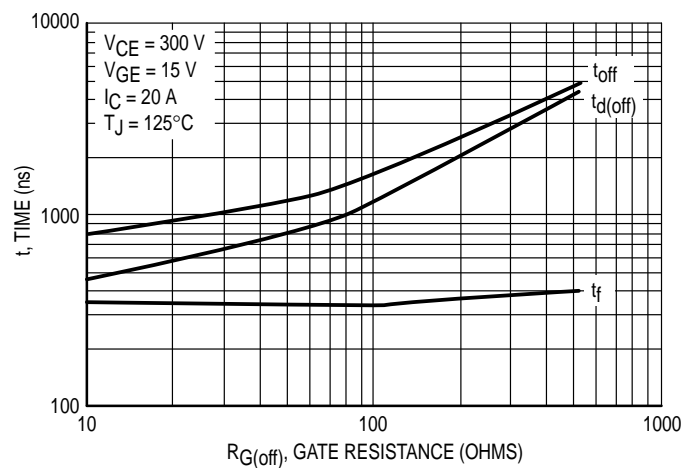

Figure 10. Inductive Switching Times versus Gate Resistance,  $T_J = 125^\circ\text{C}$

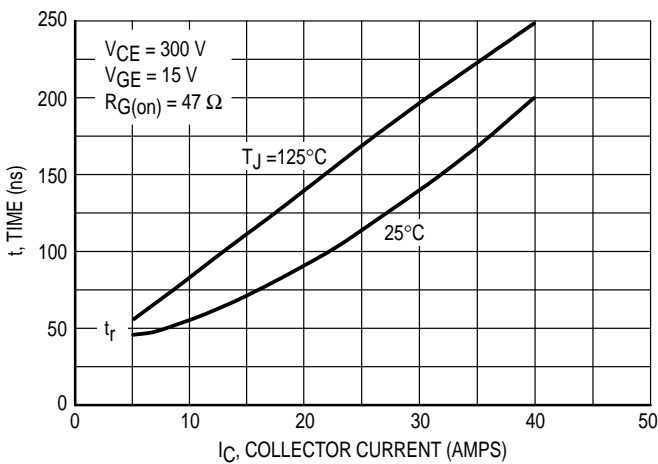

Figure 11. Inductive Switching Times versus Collector Current

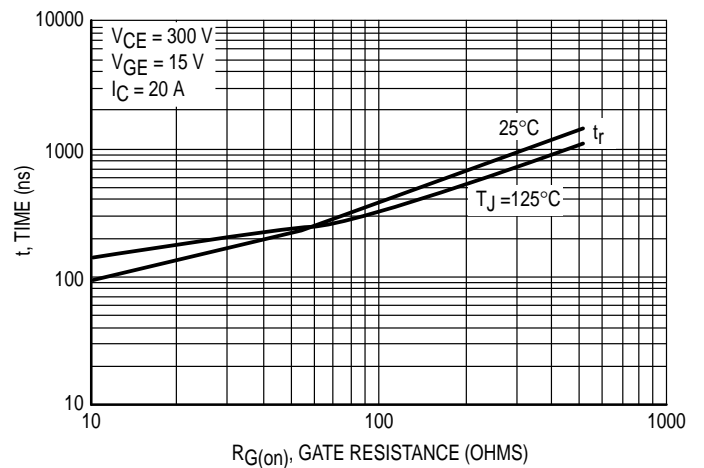
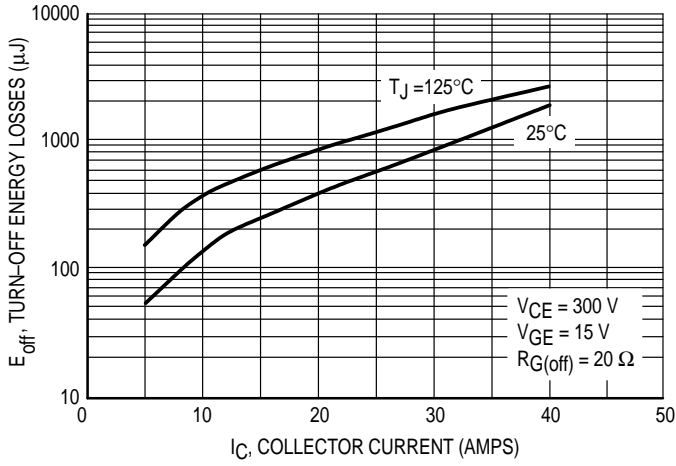

Figure 12. Inductive Switching Times versus Gate Resistance

# MHPM7B20A60A

## Typical Characteristics



**Figure 13. Turn-Off Energy Losses versus Collector Current**

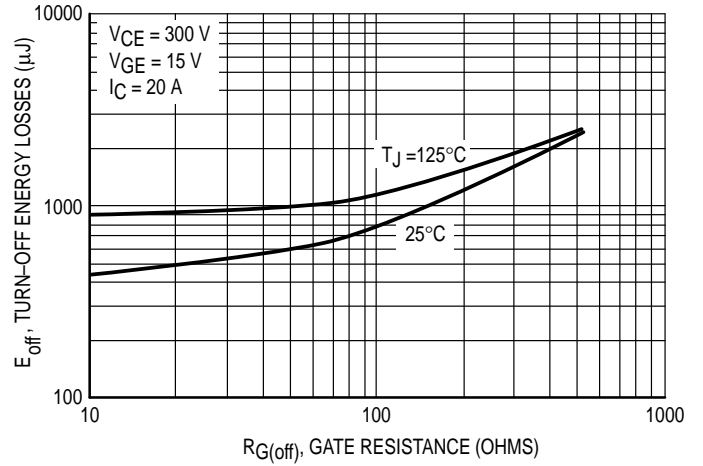

**Figure 14. Turn-Off Energy Losses versus Gate Resistance**

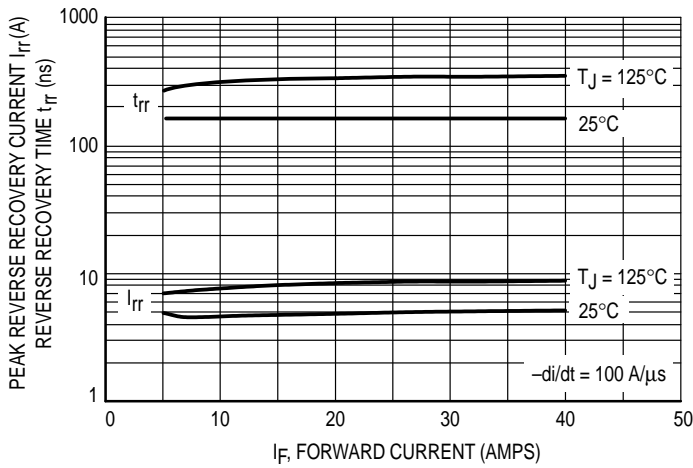

**Figure 15. Reverse Recovery Characteristics — Free-Wheeling Diode**

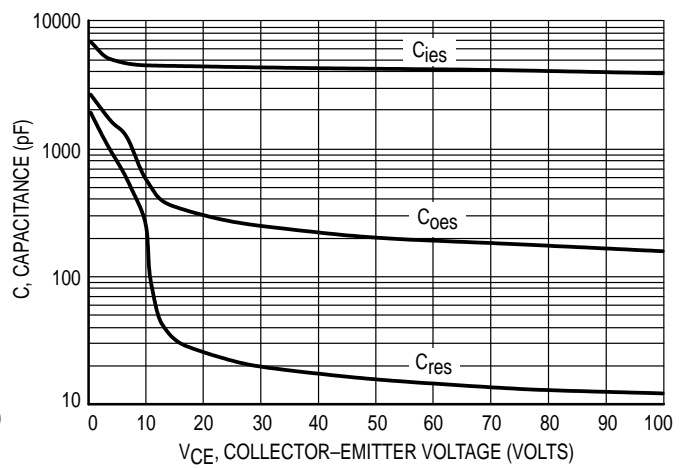

**Figure 16. Capacitance Variation**

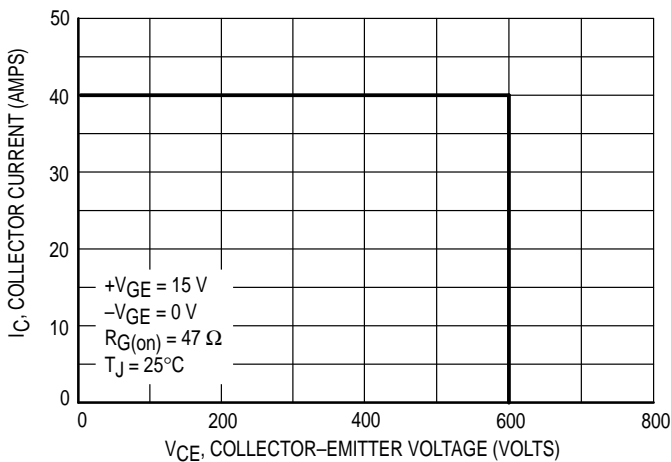

**Figure 17. Reversed Biased Safe Operating Area (RBSOA)**

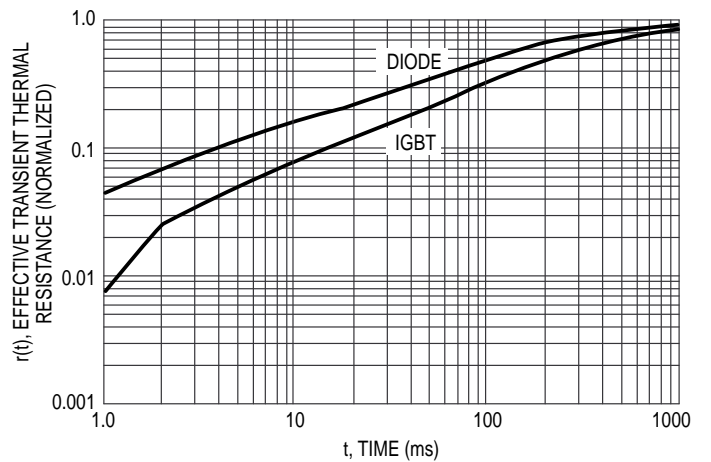

**Figure 18. Thermal Response**

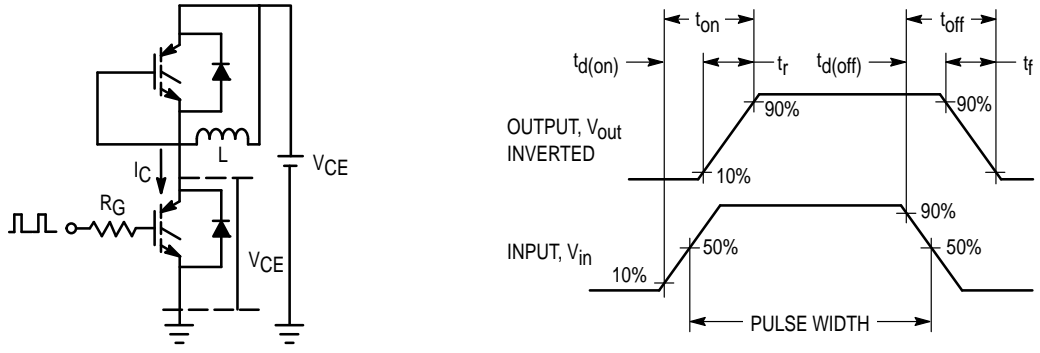
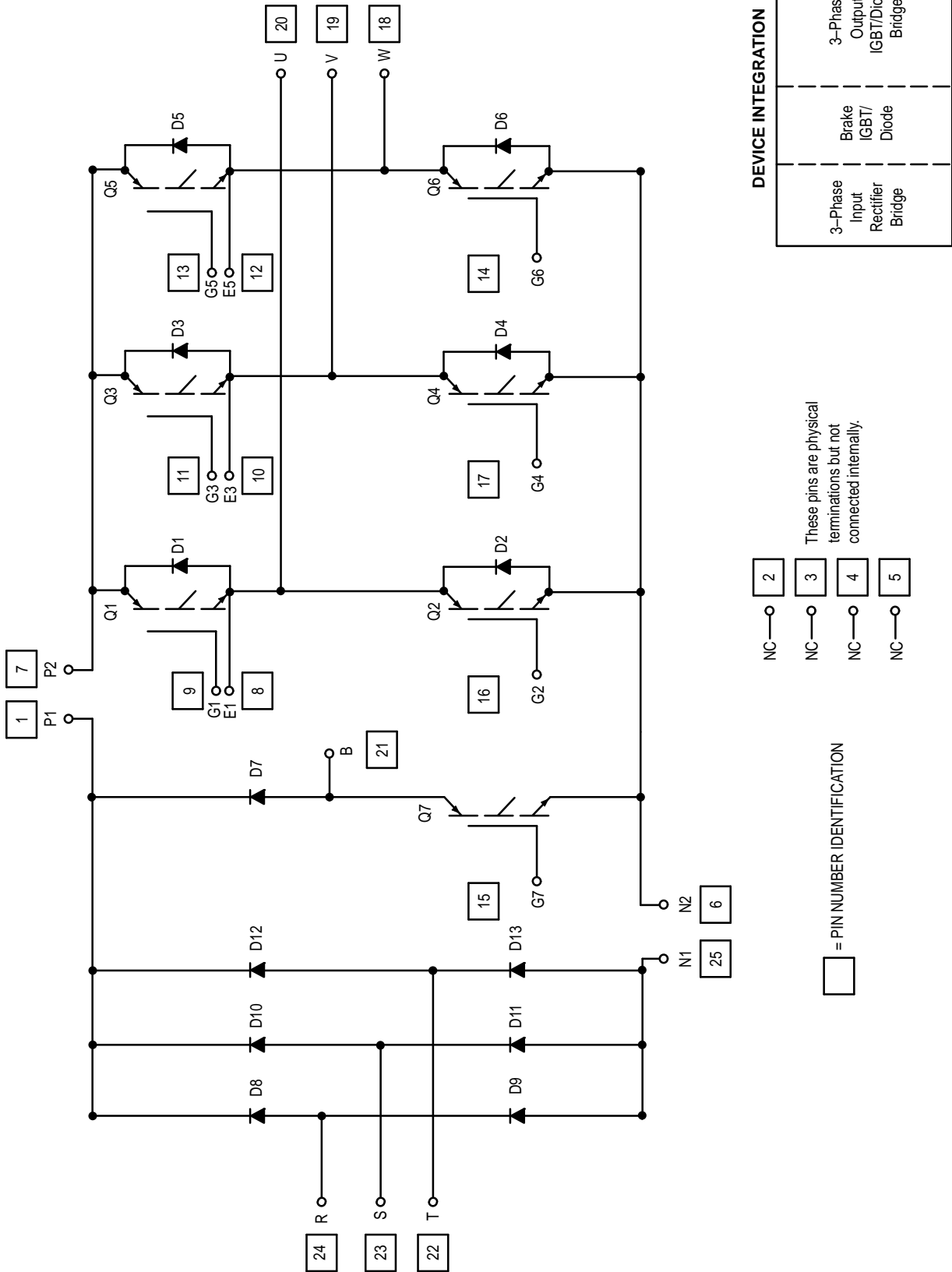

Figure 19. Inductive Switching Time Test Circuit and Timing Chart

**MHPM7B20A60A**



**DEVICE INTEGRATION**

3-Phase Input Rectifier Bridge	Brake IGBT/Diode	3-Phase Output IGBT/Diode Bridge
--------------------------------	------------------	----------------------------------

These pins are physical terminations but not connected internally.

- 2 NC
- 3 NC
- 4 NC
- 5 NC

□ = PIN NUMBER IDENTIFICATION

**Figure 20. Integrated Power Stage Schematic**



PACKAGE DIMENSIONS

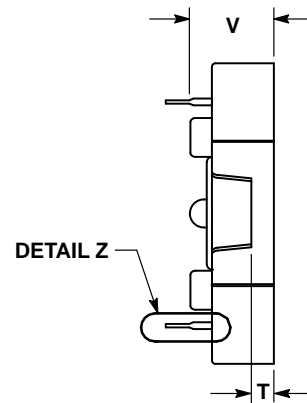
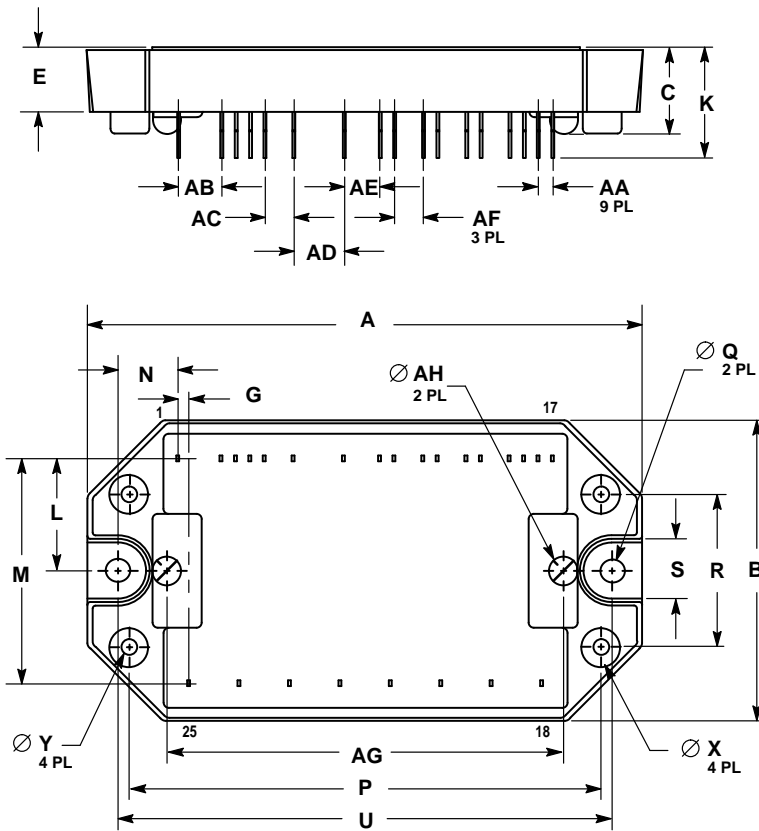

- NOTES:
1. DIMENSIONING AND TOLERANCING PER ANSI Y14.5M, 1982.
  2. CONTROLLING DIMENSION: MILLIMETER.
  3. LEAD LOCATION DIMENSIONS (ie: M, G, AA...) ARE TO THE CENTER OF THE LEAD.

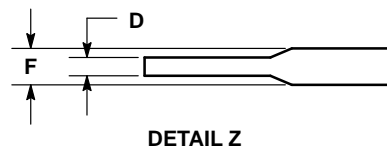
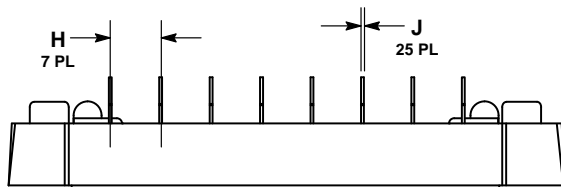

DIM	MILLIMETERS		INCHES	
	MIN	MAX	MIN	MAX
A	97.54	98.55	3.840	3.880
B	52.45	53.47	2.065	2.105
C	14.60	15.88	0.575	0.625
D	0.43	0.84	0.017	0.033
E	10.80	12.06	0.425	0.475
F	0.94	1.35	0.037	0.053
G	1.60	2.21	0.063	0.087
H	8.58	9.19	0.338	0.362
J	0.30	0.71	0.012	0.028
K	18.80	20.57	0.74	0.81
L	19.30	20.32	0.760	0.800
M	38.99	40.26	1.535	1.585
N	9.78	11.05	0.385	0.435
P	82.55	83.57	3.250	3.290
Q	4.01	4.62	0.158	0.182
R	26.42	27.43	1.040	1.080
S	12.06	12.95	0.475	0.515
T	4.32	5.33	0.170	0.210
U	86.36	87.38	3.400	3.440
V	14.22	15.24	0.560	0.600
X	6.55	7.16	0.258	0.282
Y	2.49	3.10	0.098	0.122
AA	2.24	2.84	0.088	0.112
AB	7.32	7.92	0.288	0.312
AC	4.78	5.38	0.188	0.212
AD	8.58	9.19	0.338	0.362
AE	6.05	6.65	0.238	0.262
AF	4.78	5.38	0.188	0.212
AG	69.34	70.36	2.730	2.770
AH	—	5.08	—	0.200

# MHPM7B20A60A

Motorola reserves the right to make changes without further notice to any products herein. Motorola makes no warranty, representation or guarantee regarding the suitability of its products for any particular purpose, nor does Motorola assume any liability arising out of the application or use of any product or circuit, and specifically disclaims any and all liability, including without limitation consequential or incidental damages. "Typical" parameters which may be provided in Motorola data sheets and/or specifications can and do vary in different applications and actual performance may vary over time. All operating parameters, including "Typicals" must be validated for each customer application by customer's technical experts. Motorola does not convey any license under its patent rights nor the rights of others. Motorola products are not designed, intended, or authorized for use as components in systems intended for surgical implant into the body, or other applications intended to support or sustain life, or for any other application in which the failure of the Motorola product could create a situation where personal injury or death may occur. Should Buyer purchase or use Motorola products for any such unintended or unauthorized application, Buyer shall indemnify and hold Motorola and its officers, employees, subsidiaries, affiliates, and distributors harmless against all claims, costs, damages, and expenses, and reasonable attorney fees arising out of, directly or indirectly, any claim of personal injury or death associated with such unintended or unauthorized use, even if such claim alleges that Motorola was negligent regarding the design or manufacture of the part. Motorola and  are registered trademarks of Motorola, Inc. Motorola, Inc. is an Equal Opportunity/Affirmative Action Employer.

Mfax is a trademark of Motorola, Inc.

#### How to reach us:

**USA/EUROPE/Locations Not Listed:** Motorola Literature Distribution;  
P.O. Box 5405, Denver, Colorado 80217. 1-303-675-2140 or 1-800-441-2447

**JAPAN:** Nippon Motorola Ltd.: SPD, Strategic Planning Office, 141,  
4-32-1 Nishi-Gotanda, Shagawa-ku, Tokyo. 03-5487-8488

**Customer Focus Center: 1-800-521-6274**

**Mfax™:** RMFAX0@email.sps.mot.com – TOUCHTONE 1-602-244-6609  
Motorola Fax Back System – US & Canada ONLY 1-800-774-1848  
– <http://sps.motorola.com/mfax/>

**ASIA/PACIFIC:** Motorola Semiconductors H.K. Ltd.; 8B Tai Ping Industrial Park,  
51 Ting Kok Road, Tai Po, N.T., Hong Kong. 852-26629298

**HOME PAGE:** <http://motorola.com/sps/>



**MOTOROLA**