

MR4045

Automotive Transient Voltage Suppressor

34 V – 45 V

Designed for Automotive Applications (Alternator) requiring Reverse Avalanche Capability for use as Transient Voltage Suppressor. Developed to suppress transients in automotive systems, this device operates in the forward mode as Standard Rectifier or in Reverse as Transient Voltage Suppressor for Centralized Protection.

For further information referring to Mounting or Operating Conditions, contact your nearest ON Semiconductor Sales Representative.

Mechanical Characteristics

- Finish: 100% Tin Plated
All External Surfaces are Corrosion Resistant
- Weight: 2.6 Grams (Approximately)

Packaging/Labeling

- Two Sealed Bags into a Cardboard Box
- Device Number Labeled on the Bag

Marking

- The Pieces are Laser Marked on the Epoxy of the Diode
- The part, divided into 4 quarters, has the following marking:
 - On the top quarter: 1 digit for the polarity (N or P), 1 digit for the voltage code (2 for 34–45 V), 4 digits for the date code (YYMM)
 - On the left and right quarter: 1 digit for the polarity (N or P)
 - On the bottom quarter: 2 digits for the site code (NL for Czech Republic) and 3 digits for the assembly lot number

MAXIMUM RATING

Rating	Symbol	Value	Unit
DC Blocking Voltage	V_R	30	Volts
Average Forward Current (Single Phase, Resistive Load, $T_C = 185^\circ\text{C}$)	I_O	40	Amps
Peak Repetitive Reverse Surge Current (Time Constant = 10 ms, $T_C = 25^\circ\text{C}$) (Time Constant = 80 ms, $T_C = 25^\circ\text{C}$)	I_{RSM} I_{RSM}	55 25	Amps
Non-Repetitive Peak Surge Current (Halfwave, Single Phase, 50 Hz)	I_{FSM}	500	Amps
Storage Temperature Range	T_{stg}	-40 to +200	$^\circ\text{C}$
Maximum Operating Junction Temperature	T_J	200	$^\circ\text{C}$



ON Semiconductor

Formerly a Division of Motorola

<http://onsemi.com>



N SUFFIX
(Anode to Cup)
P SUFFIX
(Cathode to Cup)
CASE 193A

ORDERING INFORMATION

Device	Package	Shipping
MR4045N	Button Can	5000/Box
MR4045P	Button Can	5000/Box



MR4045

THERMAL CHARACTERISTICS

Characteristic	Symbol	Value	Unit
Thermal Resistance Junction to Case	$R_{\theta JC}$	0.4	$^{\circ}C/W$

ELECTRICAL CHARACTERISTICS

Characteristic	Symbol	Min	Max	Unit
Instantaneous Forward Voltage ⁽¹⁾ ($I_F = 100$ Amps, $T_C = 25^{\circ}C$)	V_F	—	1.1	Volts
Reverse Current ⁽¹⁾ ($V_R = 28$ Vdc, $T_C = 25^{\circ}C$)	I_R	—	1.0	μA
Breakdown Voltage ⁽¹⁾ ($I_R = 100$ mA, $T_C = 25^{\circ}C$)	$V_{(BR)}$	34	45	Volts
Breakdown Voltage ($I_R = 80$ Amps, $T_C = 25^{\circ}C$, $PW = 80 \mu s$) ($I_R = 80$ Amps, $T_C = 85^{\circ}C$, $PW = 80 \mu s$)	$V_{(BR)}$	—	53 55	Volts
Breakdown Voltage Temperature Coefficient	$V_{(BR)TC}$	0.095*		$\%/^{\circ}C$
Forward Voltage Temperature Coefficient ($I_F = 10$ mA)	V_{FTC}	-2*		$mV/^{\circ}C$

(1) Pulse Test: Pulse Width < 300 μs , Duty Cycle < 2%.

*Typical

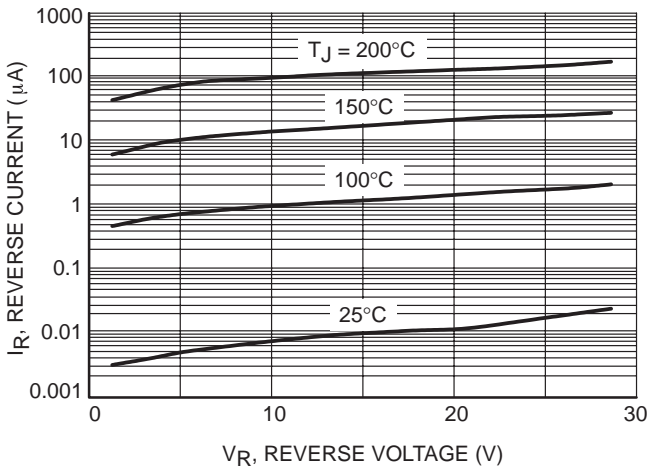

Figure 1. Typical Reverse Current

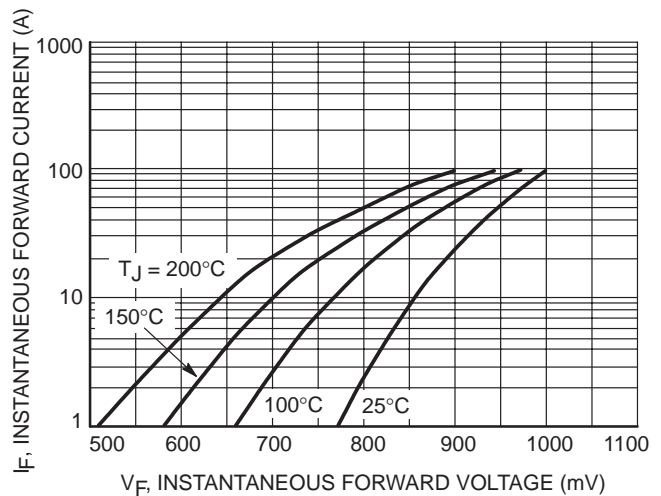

Figure 2. Typical Forward Voltage

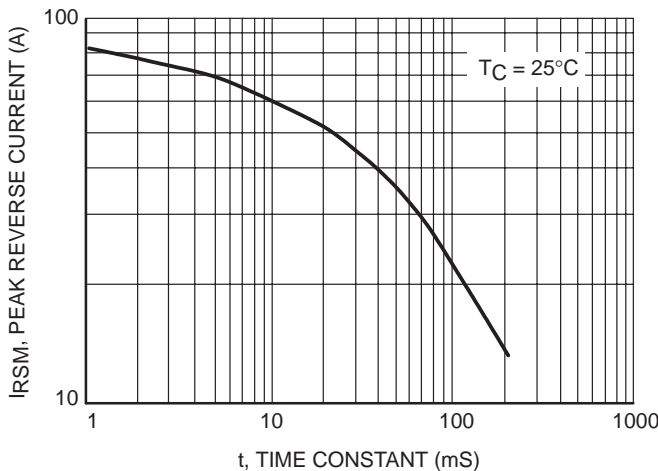

Figure 3. Maximum Peak Reverse Current

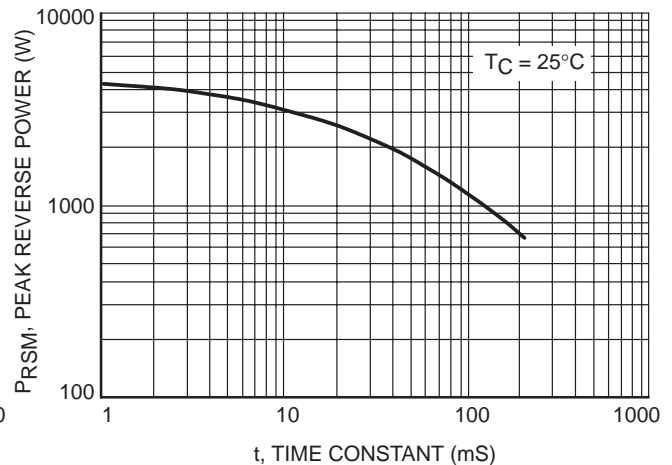

Figure 4. Maximum Peak Reverse Power

MR4045

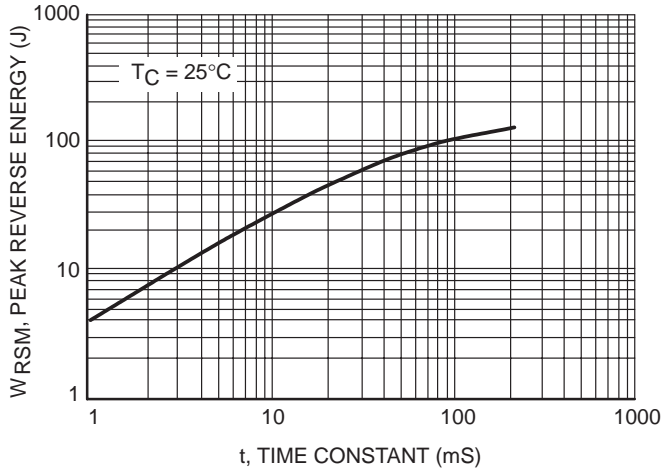

Figure 5. Maximum Reverse Energy

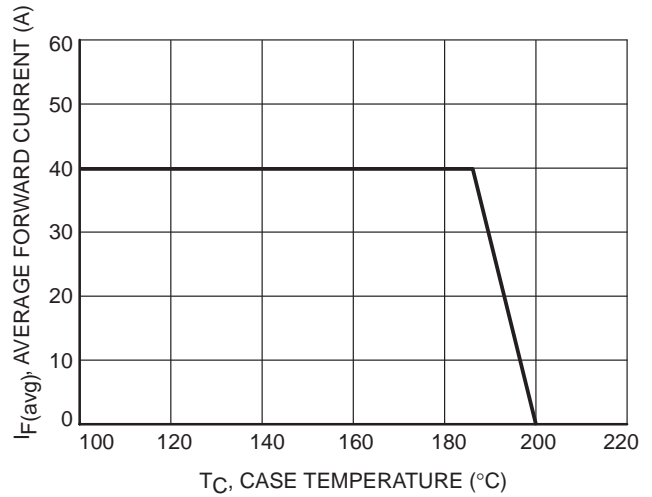

Figure 6. Maximum Current Rating

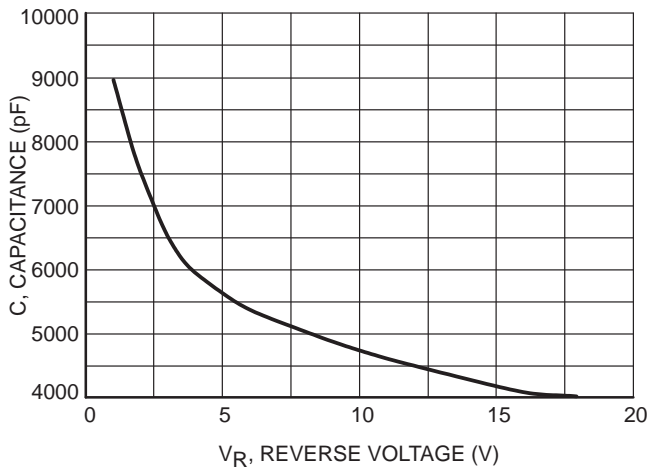

Figure 7. Typical Capacitance

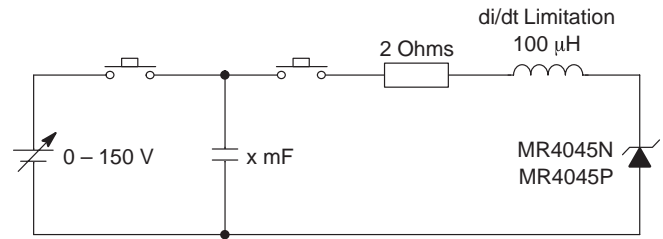

Figure 8. Load Dump Test Circuit

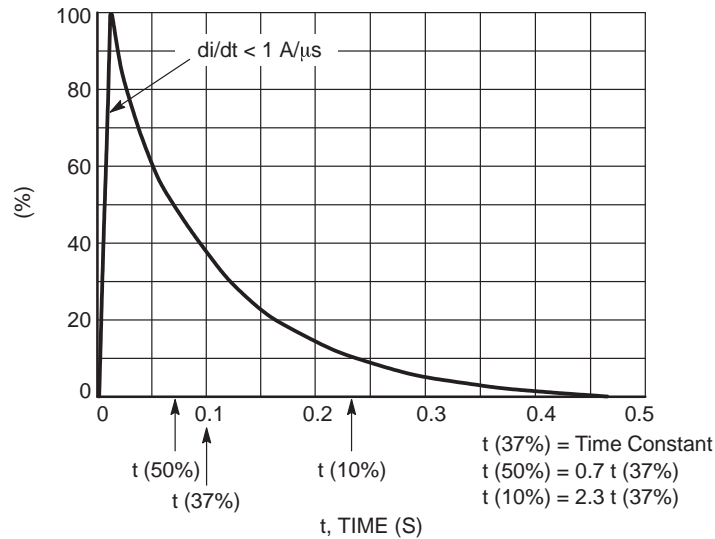
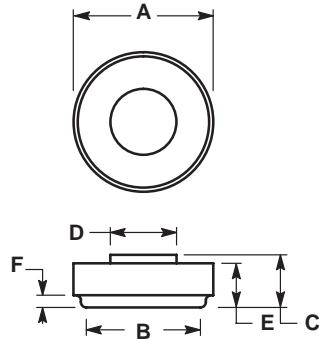

Figure 9. Load Dump Pulse Current

MR4045

PACKAGE DIMENSIONS

N SUFFIX
(Anode to Cup)
P SUFFIX
(Cathode to Cup)
CASE 193A-02
ISSUE A



NOTES:

1. DIMENSIONING AND TOLERANCING PER ANSI Y14.5M, 1982.
2. CONTROLLING DIMENSION: MILLIMETER.

DIM	MILLIMETERS		INCHES	
	MIN	MAX	MIN	MAX
A	11.4	11.6	0.449	0.457
B	9.3	9.7	0.366	0.382
C	4.3	4.9	0.169	0.193
D	5.4	5.6	0.213	0.220
E	3.6	4.2	0.142	0.165
F	1.0	2.0	0.039	0.079

ON Semiconductor and  are trademarks of Semiconductor Components Industries, LLC (SCILLC). SCILLC reserves the right to make changes without further notice to any products herein. SCILLC makes no warranty, representation or guarantee regarding the suitability of its products for any particular purpose, nor does SCILLC assume any liability arising out of the application or use of any product or circuit, and specifically disclaims any and all liability, including without limitation special, consequential or incidental damages. "Typical" parameters which may be provided in SCILLC data sheets and/or specifications can and do vary in different applications and actual performance may vary over time. All operating parameters, including "Typicals" must be validated for each customer application by customer's technical experts. SCILLC does not convey any license under its patent rights nor the rights of others. SCILLC products are not designed, intended, or authorized for use as components in systems intended for surgical implant into the body, or other applications intended to support or sustain life, or for any other application in which the failure of the SCILLC product could create a situation where personal injury or death may occur. Should Buyer purchase or use SCILLC products for any such unintended or unauthorized application, Buyer shall indemnify and hold SCILLC and its officers, employees, subsidiaries, affiliates, and distributors harmless against all claims, costs, damages, and expenses, and reasonable attorney fees arising out of, directly or indirectly, any claim of personal injury or death associated with such unintended or unauthorized use, even if such claim alleges that SCILLC was negligent regarding the design or manufacture of the part. SCILLC is an Equal Opportunity/Affirmative Action Employer.

PUBLICATION ORDERING INFORMATION

USA/EUROPE Literature Fulfillment:

Literature Distribution Center for ON Semiconductor
P.O. Box 5163, Denver, Colorado 80217 USA
Phone: 303-675-2175 or 800-344-3860 Toll Free USA/Canada
Fax: 303-675-2176 or 800-344-3867 Toll Free USA/Canada
Email: ONlit@hibbertco.com

Fax Response Line*: 303-675-2167
800-344-3810 Toll Free USA/Canada
*To receive a Fax of our publications

N. America Technical Support: 800-282-9855 Toll Free USA/Canada

ASIA/PACIFIC: LDC for ON Semiconductor – Asia Support

Phone: 303-675-2121 (Tue-Fri 9:00am to 1:00pm, Hong Kong Time)
Email: ONlit-asia@hibbertco.com

JAPAN: ON Semiconductor, Japan Customer Focus Center

4-32-1 Nishi-Gotanda, Shinagawa-ku, Tokyo, Japan 141-8549
Phone: 81-3-5487-8345
Email: r14153@onsemi.com

ON Semiconductor Website: <http://onsemi.com>

For additional information, please contact your local Sales Representative.