

## 2.7-V TO 5.5-V 10-BIT 3- $\mu$ S QUADRUPLE DIGITAL-TO-ANALOG CONVERTERS WITH POWER DOWN

SLAS176A – DECEMBER 1997 – REVISED SEPTEMBER 1998

- Four 10-Bit D/A Converters
- Programmable Settling Time of 3  $\mu$ s or 9  $\mu$ s Typ
- TMS320, (Q)SPI, and Microwire Compatible Serial Interface
- Internal Power-On Reset
- Low Power Consumption:  
5.5 mW, Slow Mode – 5-V Supply  
3.3 mW, Slow Mode – 3-V Supply
- Reference Input Buffers
- Voltage Output Range . . . 2 $\times$  the Reference Input Voltage
- Monotonic Over Temperature
- Dual 2.7-V to 5.5-V Supply (Separate Digital and Analog Supplies)

- Hardware Power Down (10 nA)
- Software Power Down (10 nA)
- Simultaneous Update

### applications

- Battery Powered Test Instruments
- Digital Offset and Gain Adjustment
- Industrial Process Controls
- Machine and Motion Control Devices
- Communications
- Arbitrary Waveform Generation

### description

The TLV5604 is a quadruple 10-bit voltage output digital-to-analog converter (DAC) with a flexible 4-wire serial interface. The 4-wire serial interface allows glueless interface to TMS320, SPI, QSPI, and Microwire serial ports. The TLV5604 is programmed with a 16-bit serial word comprised of a DAC address, individual DAC control bits, and a 10-bit DAC value.

The device has provision for two supplies: one digital supply for the serial interface (via pins DV<sub>DD</sub> and DGND), and one for the DACs, reference buffers and output buffers (via pins AV<sub>DD</sub> and AGND). Each supply is independent of the other, and can be any value between 2.7 V and 5.5 V. The dual supplies allow a typical application where the DAC will be controlled via a microprocessor operating on a 3-V supply (also used on pins DV<sub>DD</sub> and DGND), with the DACs operating on a 5-V supply. Of course, the digital and analog supplies can be tied together.

The resistor string output voltage is buffered by a x2 gain rail-to-rail output buffer. The buffer features a Class AB output stage to improve stability and reduce settling time. A rail-to-rail output stage and a power-down mode makes it ideal for single voltage, battery based applications. The settling time of the DAC is programmable to allow the designer to optimize speed versus power dissipation. The settling time is chosen by the control bits within the 16-bit serial input string. A high-impedance buffer is integrated on the REFINAB and REFINCD terminals to reduce the need for a low source impedance drive to the terminal. REFINAB and REFINCD allow DACs A and B to have a different reference voltage than DACs C and D.

The device, implemented with a CMOS process, is available in 16-terminal SOIC and TSSOP packages. The TLV5604C is characterized for operation from 0°C to 70°C. The TLV5604I is characterized for operation from -40°C to 85°C.

D OR PW PACKAGE  
(TOP VIEW)

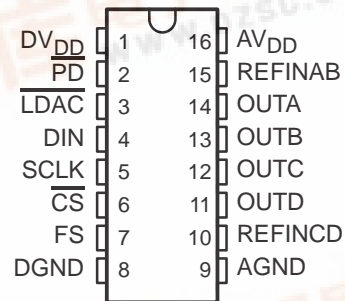

Please be aware that an important notice concerning availability, standard warranty, and use in critical applications of Texas Instruments semiconductor products and disclaimers thereto appears at the end of this data sheet.

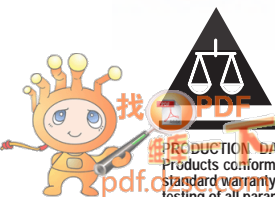

# TLV5604

## 2.7-V TO 5.5-V 10-BIT 3- $\mu$ S QUADRUPLE DIGITAL-TO-ANALOG CONVERTERS WITH POWER DOWN

SLAS176A – DECEMBER 1997 – REVISED SEPTEMBER 1998

### AVAILABLE OPTIONS

T <sub>A</sub>	PACKAGE	
	SOIC (D)	TSSOP (PW)
0°C to 70°C	TLV5604CD	TLV5604CPW
-40°C to 85°C	TLV5604ID	TLV5604IPW

### functional block diagram

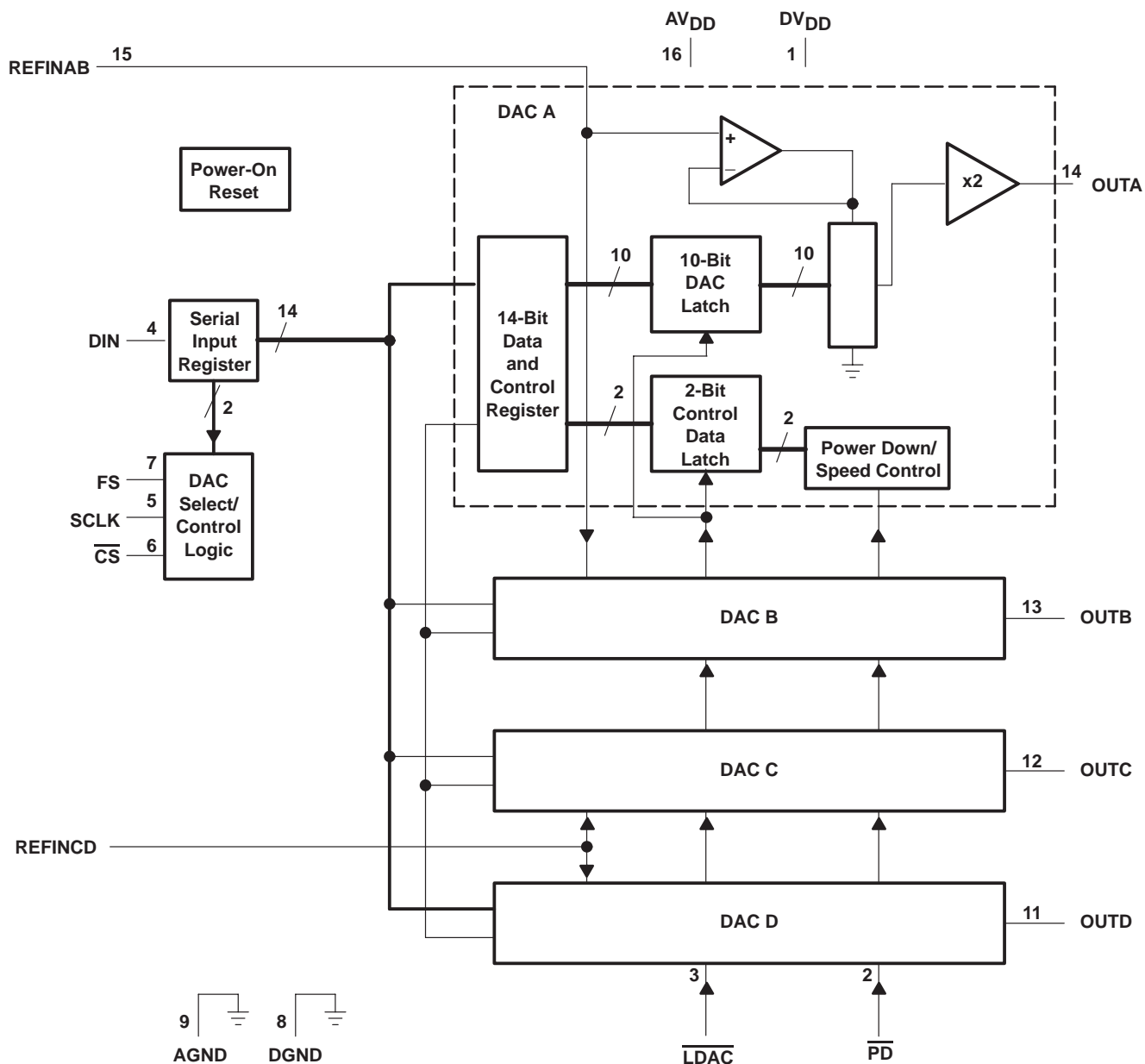

TLV5604

## 2.7-V TO 5.5-V 10-BIT 3- $\mu$ S QUADRUPLE DIGITAL-TO-ANALOG CONVERTERS WITH POWER DOWN

SLAS176A – DECEMBER 1997 – REVISED SEPTEMBER 1998

### Terminal Functions

TERMINAL NAME	NO.	I/O	DESCRIPTION
AGND	9		Analog ground
AV <sub>DD</sub>	16		Analog supply
$\overline{\text{CS}}$	6	I	Chip select. This terminal is active low.
DGND	8		Digital ground
DIN	4	I	Serial data input
DV <sub>DD</sub>	1		Digital supply
FS	7	I	Frame sync input. The falling edge of the frame sync pulse indicates the start of a serial data frame shifted out to the TLV5604.
$\overline{\text{PD}}$	2	I	Power-down pin. Powers down all DACs (overriding their individual power down settings), and all output stages. This terminal is active low.
$\overline{\text{LDAC}}$	3	I	Load DAC. When the $\overline{\text{LDAC}}$ signal is high, no DAC output updates occur when the input digital data is read into the serial interface. The DAC outputs are only updated when $\overline{\text{LDAC}}$ is low.
REFINAB	15	I	Voltage reference input for DACs A and B.
REFINCD	10	I	Voltage reference input for DACs C and D.
SCLK	5	I	Serial Clock input
OUTA	14	O	DAC A output
OUTB	13	O	DAC B output
OUTC	12	O	DAC C output
OUTD	11	O	DAC D output

#### absolute maximum ratings over operating free-air temperature range (unless otherwise noted)†

Supply voltage, (DV <sub>DD</sub> , AV <sub>DD</sub> to GND)	7 V
Supply voltage difference, (AV <sub>DD</sub> to DV <sub>DD</sub> )	–2.8 V to 2.8 V
Digital input voltage range	–0.3 V to DV <sub>DD</sub> + 0.3 V
Reference input voltage range	–0.3 V to AV <sub>DD</sub> + 0.3 V
Operating free-air temperature range, T <sub>A</sub> : TLV5604C	0°C to 70°C
TLV5604I	–40°C to 85°C
Storage temperature range, T <sub>stg</sub>	–65°C to 150°C
Lead temperature 1,6 mm (1/16 inch) from case for 10 seconds	260°C

† Stresses beyond those listed under “absolute maximum ratings” may cause permanent damage to the device. These are stress ratings only, and functional operation of the device at these or any other conditions beyond those indicated under “recommended operating conditions” is not implied. Exposure to absolute-maximum-rated conditions for extended periods may affect device reliability.

# TLV5604

## 2.7-V TO 5.5-V 10-BIT 3- $\mu$ S QUADRUPLE DIGITAL-TO-ANALOG CONVERTERS WITH POWER DOWN

SLAS176A – DECEMBER 1997 – REVISED SEPTEMBER 1998

### recommended operating conditions

		MIN	NOM	MAX	UNIT
Supply voltage, AV <sub>DD</sub> , DV <sub>DD</sub>	5-V supply	4.5	5	5.5	V
	3-V supply	2.7	3	3.3	
High-level digital input, V <sub>IH</sub>	DV <sub>DD</sub> = 2.7 V to 5.5 V	2			V
Low-level digital input, V <sub>IL</sub>	DV <sub>DD</sub> = 2.7 V to 5.5 V			0.8	V
Reference voltage, V <sub>ref</sub> to REFINAB, REFINCD terminal	5-V supply (see Note 1)	0	2.048	AV <sub>DD</sub> -1.5	V
	3-V supply (see Note 1)	0	1.024	AV <sub>DD</sub> -1.5	
Load resistance, R <sub>L</sub>		2	10		k $\Omega$
Load capacitance, C <sub>L</sub>				100	pF
Serial clock rate, SCLK				20	MHz
Operating free-air temperature	TLV5604C	0		70	$^{\circ}$ C
	TLV5604I	-40		85	

NOTE 1: Voltages greater than AV<sub>DD</sub>/2 will cause output saturation for large DAC codes.

### electrical characteristics over recommended operating free-air temperature range (unless otherwise noted)

#### static DAC specifications

PARAMETER		TEST CONDITIONS	MIN	TYP	MAX	UNIT
Resolution			10			bits
Integral nonlinearity (INL), end point adjusted		See Note 2			$\pm 1$	LSB
Differential nonlinearity (DNL)		See Note 3		$\pm 0.1$	$\pm 1$	LSB
EZS	Zero scale error (offset error at zero scale)	See Note 4			$\pm 12$	mV
Zero scale error temperature coefficient		See Note 5		10		ppm/ $^{\circ}$ C
E <sub>G</sub>	Gain error	See Note 6			$\pm 0.6$	% of FS voltage
Gain error temperature coefficient		See Note 7		10		ppm/ $^{\circ}$ C
PSRR	Power supply rejection ratio	Zero scale gain	See Notes 8 and 9	-80		dB
		Gain		-80		

- NOTES:
- The relative accuracy or integral nonlinearity (INL) sometimes referred to as linearity error, is the maximum deviation of the output from the line between zero and full scale excluding the effects of zero code and full-scale errors.
  - The differential nonlinearity (DNL) sometimes referred to as differential error, is the difference between the measured and ideal 1 LSB amplitude change of any two adjacent codes. Monotonic means the output voltage changes in the same direction (or remains constant) as a change in the digital input code.
  - Zero-scale error is the deviation from zero voltage output when the digital input code is zero.
  - Zero-scale-error temperature coefficient is given by:  $E_{ZS} TC = [E_{ZS}(T_{max}) - E_{ZS}(T_{min})] / V_{ref} \times 10^6 / (T_{max} - T_{min})$ .
  - Gain error is the deviation from the ideal output ( $2V_{ref} - 1$  LSB) with an output load of 10 k $\Omega$  excluding the effects of the zero-error.
  - Gain temperature coefficient is given by:  $E_G TC = [E_G(T_{max}) - E_G(T_{min})] / V_{ref} \times 10^6 / (T_{max} - T_{min})$ .
  - Zero-scale-error rejection ratio (EZS-RR) is measured by varying the AV<sub>DD</sub> from 5  $\pm$  0.5 V and 3  $\pm$  0.5 V dc, and measuring the proportion of this signal imposed on the zero-code output voltage.
  - Gain-error rejection ratio (EG-RR) is measured by varying the AV<sub>DD</sub> from 5  $\pm$  0.5 V and 3  $\pm$  0.5 V dc and measuring the proportion of this signal imposed on the full-scale output voltage after subtracting the zero scale change.

TLV5604

**2.7-V TO 5.5-V 10-BIT 3- $\mu$ S QUADRUPLE DIGITAL-TO-ANALOG CONVERTERS  
WITH POWER DOWN**

SLAS176A – DECEMBER 1997 – REVISED SEPTEMBER 1998

**electrical characteristics over recommended operating free-air temperature range  
(unless otherwise noted) (continued)**

**individual DAC output specifications**

PARAMETER	TEST CONDITIONS	MIN	TYP	MAX	UNIT
$V_O$ Voltage output	$R_L = 10\text{ k}\Omega$	0		$AV_{DD}-0.1$	V
Output load regulation accuracy	$R_L = 2\text{ k}\Omega$ vs $10\text{ k}\Omega$		0.1	0.25	% of FS voltage

**reference input (REFINAB, REFINCD)**

PARAMETER	TEST CONDITIONS	MIN	TYP	MAX	UNIT
$V_I$ Input voltage range	See Note 10	0		$AV_{DD}-1.5$	V
$R_I$ Input resistance			10		$M\Omega$
$C_I$ Input capacitance			5		pF
Reference feed through	REFIN = $1 V_{pp}$ at 1 kHz + 1.024 V dc (see Note 11)		-75		dB
Reference input bandwidth	REFIN = $0.2 V_{pp}$ + 1.024 V dc	Slow	0.5		MHz
		Fast	1		

NOTES: 10. Reference input voltages greater than  $V_{DD}/2$  will cause output saturation for large DAC codes.

11. Reference feedthrough is measured at the DAC output with an input code = 000 hex and a  $V_{ref}$ (REFINAB or REFINCD) input = 1.024 Vdc +  $1 V_{pp}$  at 1 kHz.

**digital inputs ( $D_0$ – $D_{11}$ ,  $\overline{CS}$ ,  $\overline{WEB}$ ,  $\overline{LDAC}$ ,  $\overline{PD}$ )**

PARAMETER	TEST CONDITIONS	MIN	TYP	MAX	UNIT
$I_{IH}$ High-level digital input current	$V_I = DV_{DD}$			$\pm 1$	$\mu A$
$I_{IL}$ Low-level digital input current	$V_I = 0\text{ V}$			$\pm 1$	$\mu A$
$C_I$ Input capacitance			3		pF

**power supply**

PARAMETER	TEST CONDITIONS	MIN	TYP	MAX	UNIT	
$I_{DD}$ Power supply current	5-V supply, No load, Clock running	Slow	1.4	2.2	mA	
		Fast	3.5	5.5		
	3-V supply, No load, Clock running	Slow		1	1.5	mA
		Fast		3	4.5	
Power down supply current, See Figure 12			10		nA	

# TLV5604

## 2.7-V TO 5.5-V 10-BIT 3- $\mu$ S QUADRUPLE DIGITAL-TO-ANALOG CONVERTERS WITH POWER DOWN

SLAS176A – DECEMBER 1997 – REVISED SEPTEMBER 1998

### electrical characteristics over recommended operating free-air temperature range (unless otherwise noted) (continued)

#### analog output dynamic performance

PARAMETER		TEST CONDITIONS	MIN	TYP	MAX	UNIT
SR	Output slew rate	$C_L = 100 \text{ pF}$ , $R_L = 10 \text{ k}\Omega$ , $V_O = 10\% \text{ to } 90\%$ , $V_{ref} = 2.048 \text{ V}, 1024 \text{ V}$	Fast	5		$\text{V}/\mu\text{s}$
			Slow		1	$\text{V}/\mu\text{s}$
$t_s$	Output settling time	To $\pm 0.5 \text{ LSB}$ , $C_L = 100 \text{ pF}$ , $R_L = 10 \text{ k}\Omega$ , See Notes 12 and 14	Fast	2.5	4	$\mu\text{s}$
			Slow	8.5	18	
$t_{s(c)}$	Output settling time, code to code	To $\pm 0.5 \text{ LSB}$ , $C_L = 100 \text{ pF}$ , $R_L = 10 \text{ k}\Omega$ , See Note 13	Fast	1		$\mu\text{s}$
			Slow	2		
Glitch energy		Code transition from 7FF to 800		10		$\text{nV}\cdot\text{sec}$
SNR	Signal-to-noise ratio	Sinewave generated by DAC, Reference voltage = 1.024 at 3 V and 2.048 at 5 V, $f_s = 400 \text{ KSPS}$ , $f_{OUT} = 1.1 \text{ kHz}$ sinewave, $C_L = 100 \text{ pF}$ , $R_L = 10 \text{ k}\Omega$ , $BW = 20 \text{ kHz}$		68		dB
S/(N+D)	Signal to noise + distortion			65		
THD	Total harmonic Distortion			-68		
SFDR	Spurious free dynamic range			70		

NOTES: 12. Settling time is the time for the output signal to remain within  $\pm 0.5\text{LSB}$  of the final measured value for a digital input code change of 020 hex to 3FF hex or 3FF hex to 020 hex.

13. Settling time is the time for the output signal to remain within  $\pm 0.5\text{LSB}$  of the final measured value for a digital input code change of one count, 1FF hex to 200 hex.

14. Limits are ensured by design and characterization, but are not production tested.

TLV5604

## 2.7-V TO 5.5-V 10-BIT 3- $\mu$ S QUADRUPLE DIGITAL-TO-ANALOG CONVERTERS WITH POWER DOWN

SLAS176A – DECEMBER 1997 – REVISED SEPTEMBER 1998

electrical characteristics over recommended operating free-air temperature range  
(unless otherwise noted) (continued)

### digital input timing requirements

		MIN	NOM	MAX	UNIT
$t_{su}(CS-FS)$	Setup time, $\overline{CS}$ low before FS $\downarrow$	10			ns
$t_{su}(FS-CK)$	Setup time, FS low before first negative SCLK edge	8			ns
$t_{su}(C16-FS)$	Setup time, sixteenth negative edge after FS low on which bit D0 is sampled before rising edge of FS	10			ns
$t_{su}(C16-CS)$	Setup time, sixteenth positive SCLK edge (first positive after D0 is sampled) before $\overline{CS}$ rising edge. If FS is used instead of the sixteenth positive edge to update the DAC, then the setup time is between the FS rising edge and CS rising edge.	10			ns
$t_{wH}$	Pulse duration, SCLK high	25			ns
$t_{wL}$	Pulse duration, SCLK low	25			ns
$t_{su}(D)$	Setup time, data ready before SCLK falling edge	8			ns
$t_h(D)$	Hold time, data held valid after SCLK falling edge	5			ns
$t_{wH}(FS)$	Pulse duration, FS high	20			ns

### PARAMETER MEASUREMENT INFORMATION

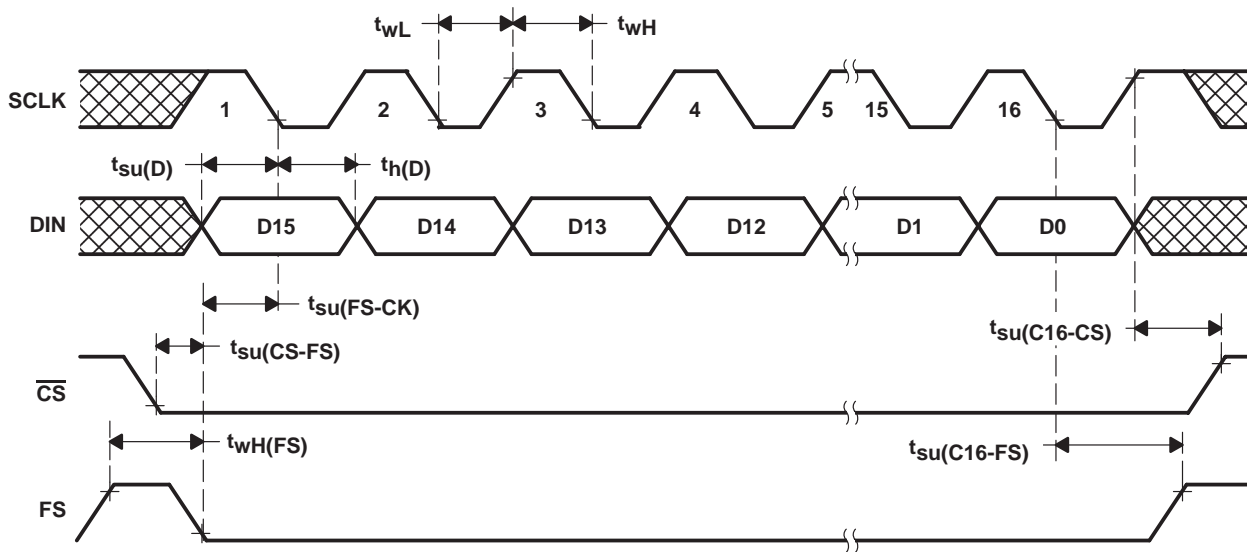

Figure 1. Timing Diagram

**TLV5604**  
**2.7-V TO 5.5-V 10-BIT 3- $\mu$ S QUADRUPLE DIGITAL-TO-ANALOG CONVERTERS**  
**WITH POWER DOWN**

SLAS176A – DECEMBER 1997 – REVISED SEPTEMBER 1998

**TYPICAL CHARACTERISTICS**

**LOAD REGULATION**

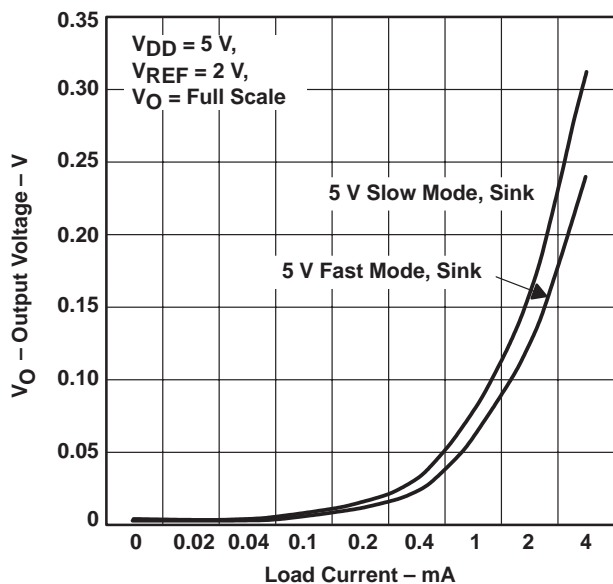

**Figure 2**

**LOAD REGULATION**

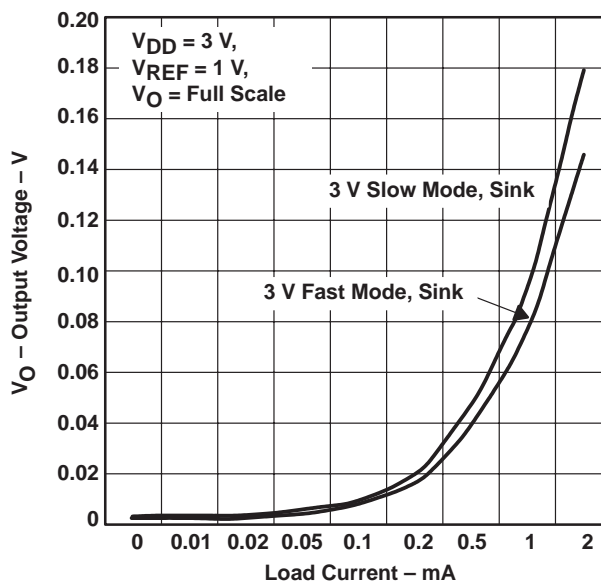

**Figure 3**

**LOAD REGULATION**

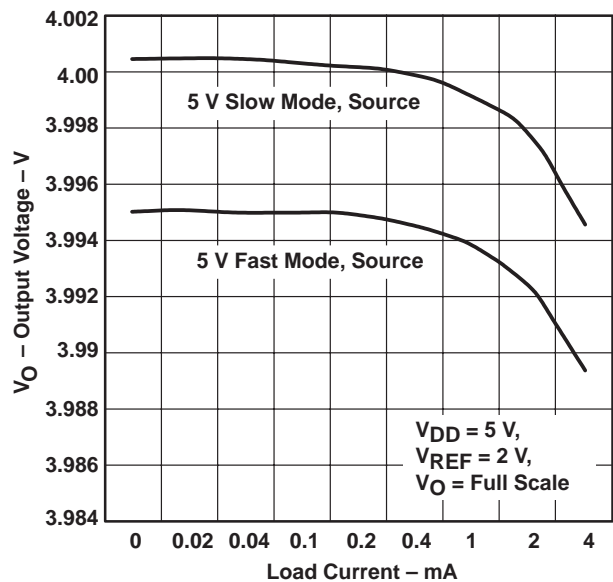

**Figure 4**

**LOAD REGULATION**

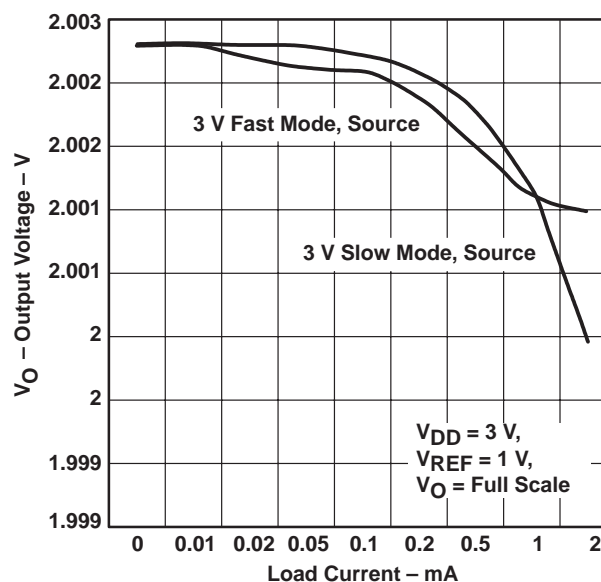

**Figure 5**



2.7-V TO 5.5-V 10-BIT 3- $\mu$ S QUADRUPLE DIGITAL-TO-ANALOG CONVERTERS WITH POWER DOWN

SLAS176A – DECEMBER 1997 – REVISED SEPTEMBER 1998

TYPICAL CHARACTERISTICS

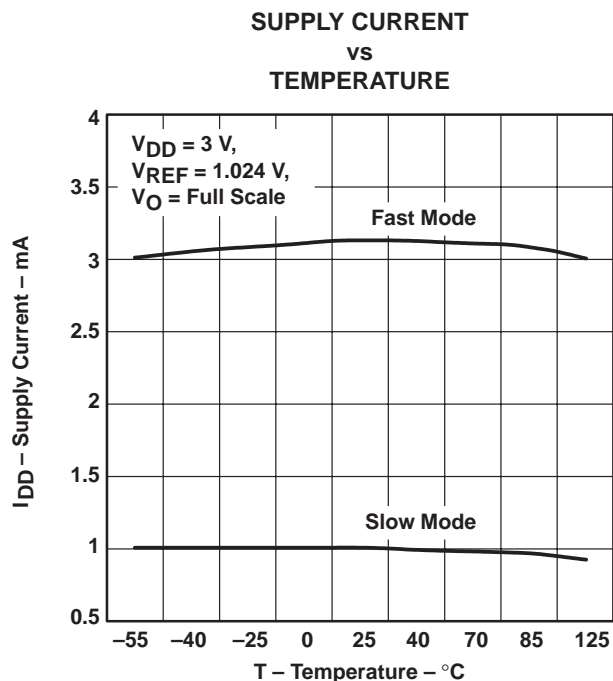

Figure 6

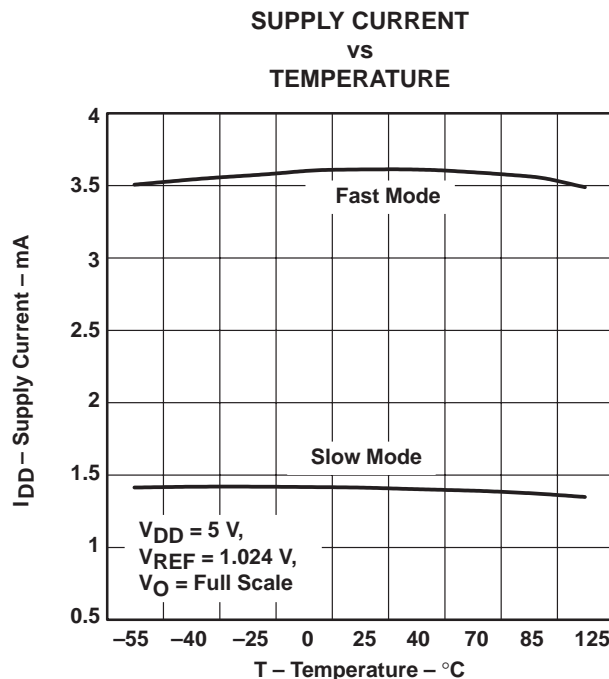

Figure 7

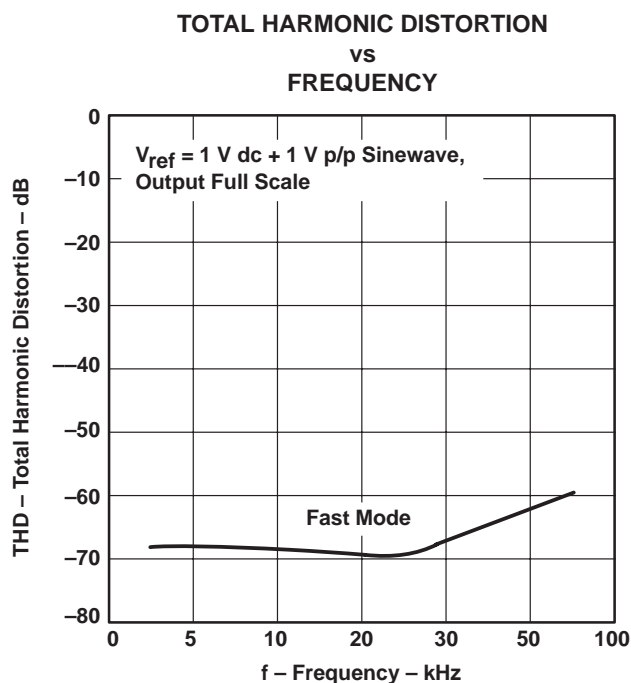

Figure 8

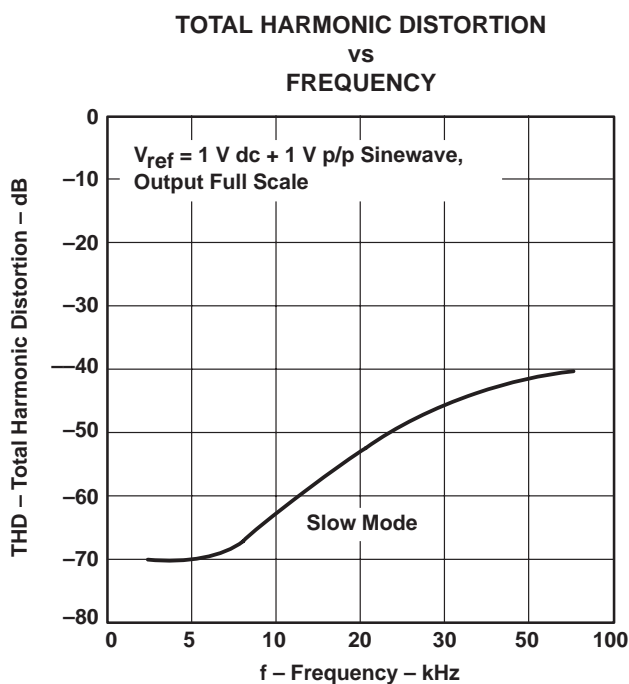

Figure 9

**TLV5604**  
**2.7-V TO 5.5-V 10-BIT 3- $\mu$ S QUADRUPLE DIGITAL-TO-ANALOG CONVERTERS**  
**WITH POWER DOWN**

SLAS176A – DECEMBER 1997 – REVISED SEPTEMBER 1998

**TYPICAL CHARACTERISTICS**

**TOTAL HARMONIC DISTORTION AND NOISE**  
**vs**  
**FREQUENCY**

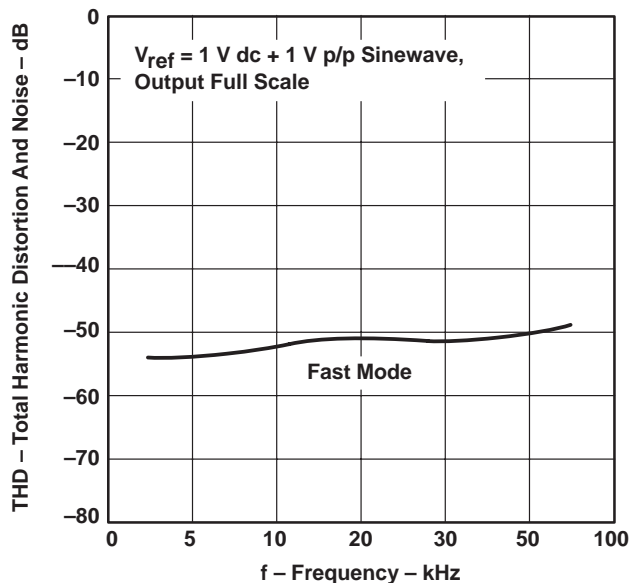

**Figure 10**

**TOTAL HARMONIC DISTORTION AND NOISE**  
**vs**  
**FREQUENCY**

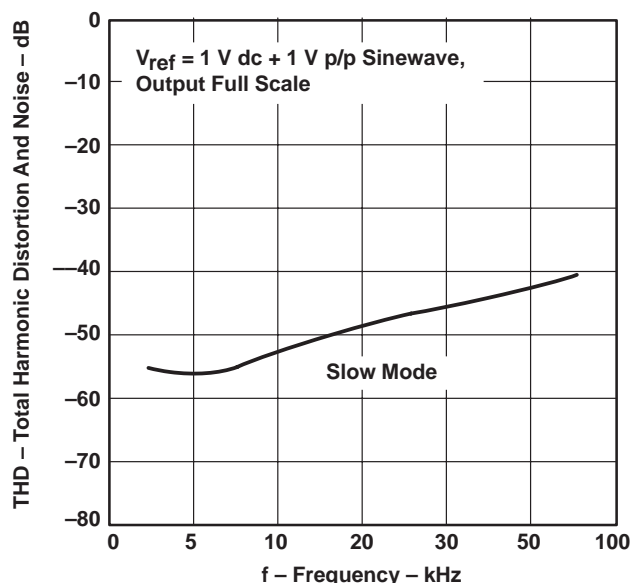

**Figure 11**

**SUPPLY CURRENT**  
**vs**  
**TIME**  
**(WHEN ENTERING POWER-DOWN MODE)**

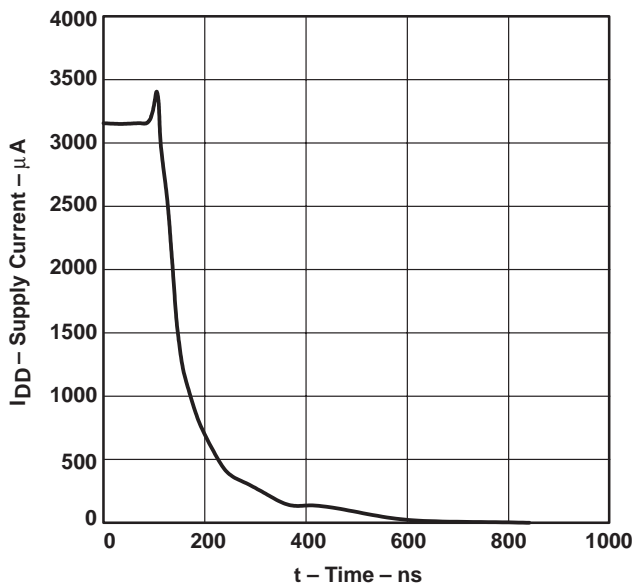

**Figure 12**

TLV5604

2.7-V TO 5.5-V 10-BIT 3- $\mu$ S QUADRUPLE DIGITAL-TO-ANALOG CONVERTERS  
WITH POWER DOWN

SLAS176A – DECEMBER 1997 – REVISED SEPTEMBER 1998

**TYPICAL CHARACTERISTICS**

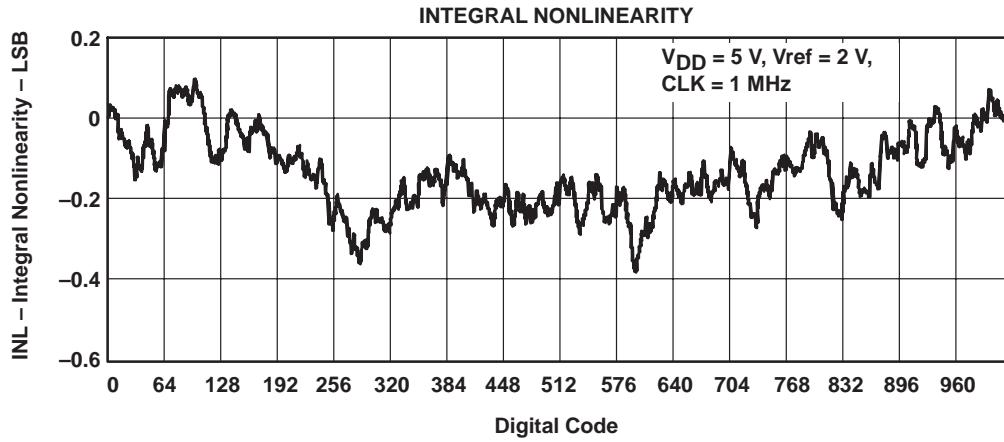

Figure 13

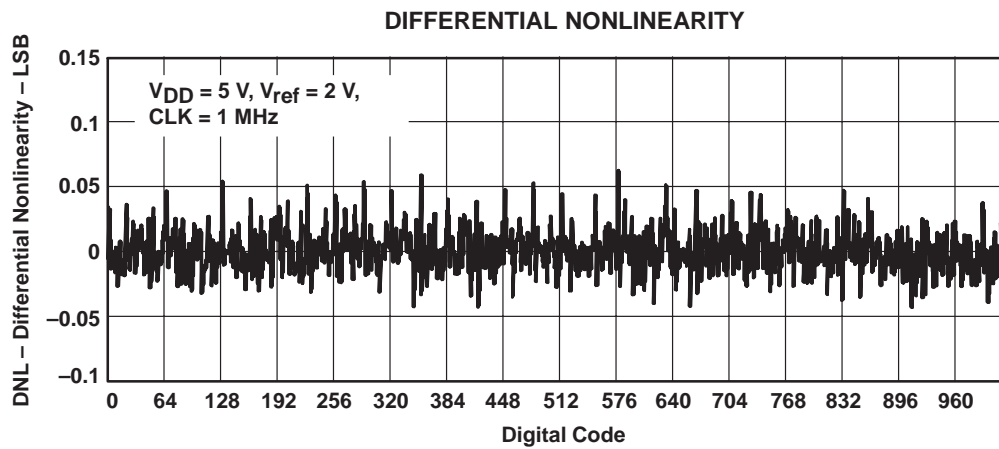

Figure 14

# TLV5604

## 2.7-V TO 5.5-V 10-BIT 3- $\mu$ S QUADRUPLE DIGITAL-TO-ANALOG CONVERTERS WITH POWER DOWN

SLAS176A – DECEMBER 1997 – REVISED SEPTEMBER 1998

### APPLICATION INFORMATION

#### general function

The TLV5604 is a 10-bit single supply DAC based on a resistor string architecture. The device consists of a serial interface, speed and power-down control logic, a reference input buffer, a resistor string, and a rail-to-rail output buffer.

The output voltage (full scale determined by external reference) is given by:

$$2 \text{ REF } \frac{\text{CODE}}{0x1000} \text{ [V]}$$

Where REF is the reference voltage and CODE is the digital input value within the range of 0x000 to 0xFF. A power-on reset initially resets the internal latches to a defined state (all bits zero).

#### serial interface

Explanation of data transfer: First, the device has to be enabled with  $\overline{\text{CS}}$  set to low. Then, a falling edge of FS starts shifting the data bit-per-bit (starting with the MSB) to the internal register on the falling edges of SCLK. After 16 bits have been transferred or FS rises, the content of the shift register is moved to the DAC latch, which updates the voltage output to the new level.

The serial interface of the TLV5604 can be used in two basic modes:

- Four wire (with chip select)
- Three wire (without chip select)

Using chip select (four wire mode), it is possible to have more than one device connected to the serial port of the data source (DSP or microcontroller). The interface is compatible with the TMS320 family. Figure 15 shows an example with two TLV5604s connected directly to a TMS320 DSP.

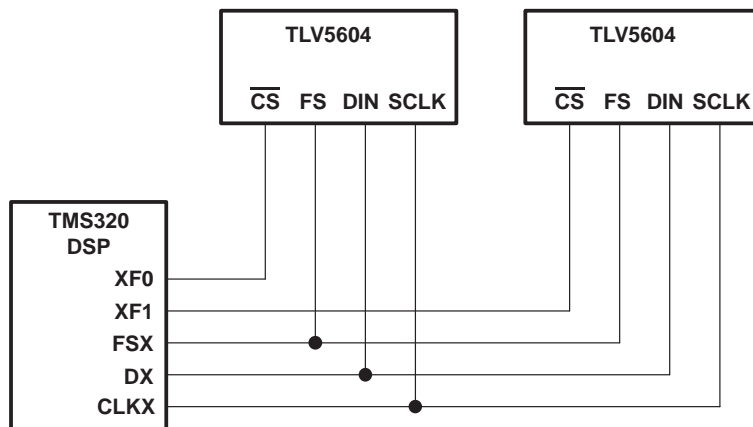

Figure 15. TMS320 Interface

TLV5604

## 2.7-V TO 5.5-V 10-BIT 3- $\mu$ S QUADRUPLE DIGITAL-TO-ANALOG CONVERTERS WITH POWER DOWN

SLAS176A – DECEMBER 1997 – REVISED SEPTEMBER 1998

### APPLICATION INFORMATION

#### serial interface (continued)

If there is no need to have more than one device on the serial bus, then  $\overline{CS}$  can be tied low. Figure 16 shows an example of how to connect the TLV5604 to a TMS320, SPI, or Microwire port using only three pins.

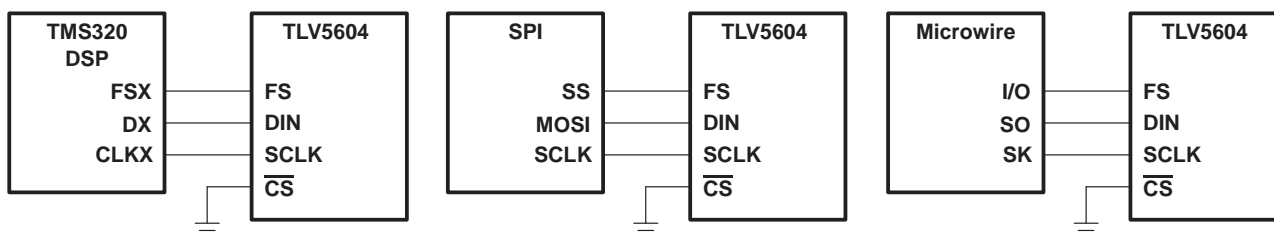

**Figure 16. Three-Wire Interface**

Notes on SPI and Microwire: Before the controller starts the data transfer, the software has to generate a falling edge on the I/O pin connected to FS. If the word width is 8 bits (SPI and Microwire), two write operations must be performed to program the TLV5604. After the write operation(s), the DAC output is updated automatically on the sixteenth positive clock edge.

#### serial clock frequency and update rate

The maximum serial clock frequency is given by:

$$f_{SCLKmax} = \frac{1}{t_{wH(min)} + t_{wL(min)}} = 20 \text{ MHz}$$

The maximum update rate is:

$$f_{UPDATEmax} = \frac{1}{16 (t_{wH(min)} + t_{wL(min)})} = 1.25 \text{ MHz}$$

Note that the maximum update rate is a theoretical value for the serial interface since the settling time of the TLV5604 has to be considered also.

#### data format

The 16-bit data word for the TLV5604 consists of two parts:

- Control bits (D15 . . . D12)
- New DAC value (D11 . . . D0)

D15	D14	D13	D12	D11	D10	D9	D8	D7	D6	D5	D4	D3	D2	D1	D0
A1	A0	PWR	SPD	New DAC value (12 bits)										X	X

X: don't care

SPD: Speed control bit. 1 → fast mode 0 → slow mode

PWR: Power control bit. 1 → power down 0 → normal operation

# TLV5604

## 2.7-V TO 5.5-V 10-BIT 3- $\mu$ S QUADRUPLE DIGITAL-TO-ANALOG CONVERTERS WITH POWER DOWN

SLAS176A – DECEMBER 1997 – REVISED SEPTEMBER 1998

### APPLICATION INFORMATION

In power down mode, all amplifiers within the TLV5604 are disabled. A particular DAC (A, B, C, D) of the TLV5604 is selected by A1 and A0 within the input word.

A1	A0	DAC
0	0	A
0	1	B
1	0	C
1	1	D

### TLV5604 interfaced to TMS320C203 DSP

#### Hardware interfacing

Figure 17 shows an example of how to connect the TLV5604 to a TMS320C203 DSP. The serial port is configured in burst mode, with FSX generated by the TMS320C203 to provide the Frame Sync (FS) input to the TLV5604. Data is transmitted on the DX line, with the serial clock input on the CLKX line. The general-purpose input/output port bits IO0 and IO1 are used to generate the Chip Select ( $\overline{CS}$ ) and DAC Latch Update ( $\overline{LDAC}$ ) inputs to the TLV5604. The active low Power Down ( $\overline{PD}$ ) is pulled high all the time to ensure the DACs are enabled.

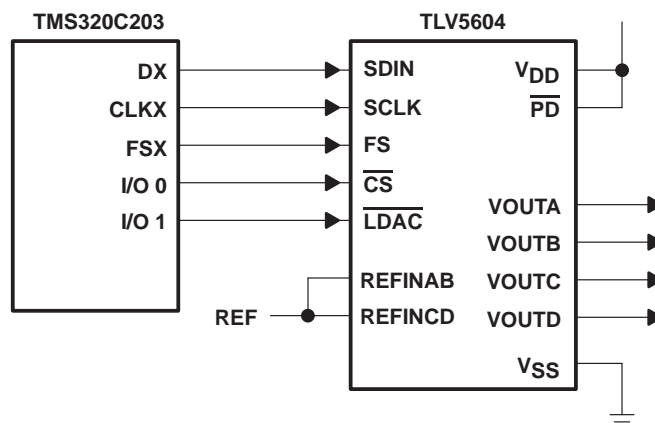

Figure 17. TLV5604 Interfaced with TMS320C203

#### Software

The application example generates a differential in-phase (sine) signal between the VOUTA and VOUTB pins, and it is quadrature (cosine) signal as the differential signal between VOUTC and VOUTD.

The on-chip timer is used to generate interrupts at a fixed frequency. The related interrupt service routine pulses LDAC low to update all 4 DACs simultaneously, then fetches and writes the next sample to all 4 DACs. The samples are stored in a look-up table, which describes two full periods of a sine wave.

The synchronous serial port of the DSP is used in burst mode. In this mode, the processor generates an FS pulse preceding the MSB of every data word. If multiple, contiguous words are transmitted, a violation of the  $t_{su}(C16-FS)$  timing requirement will occur. To avoid this, the program waits until the transmission of the previous word has been completed.

TLV5604

## 2.7-V TO 5.5-V 10-BIT 3- $\mu$ S QUADRUPLE DIGITAL-TO-ANALOG CONVERTERS WITH POWER DOWN

SLAS176A – DECEMBER 1997 – REVISED SEPTEMBER 1998

### APPLICATION INFORMATION

```

;-----;
; Processor: TMS320C203 running at 40 MHz;
; Description:
;
; This program generates a differential in-phase (sine) on (OUTA-OUTB) and it's
; quadrature (cosine) as a differential signal on (OUTC-OUTD).
;
; The DAC codes for the signal samples are stored as a table of 64 12-bit values,
; describing 2 periods of a sine function. A rolling pointer is used to address the
; table location in the first period of this waveform, from which the DAC A samples are
; read. The samples for the other 3 DACs are read at an offset to this rolling pointer:
; DAC      Function      Offset from rolling pointer;
; A       sine           0
; B       inverse sine   16
; C       cosine         8
; D       inverse cosine  24
;
; The on-chip timer is used to generate interrupts at a fixed rate. The interrupt
; service routine first pulses LDAC low to update all DACs simultaneously with the
; values which were written to them in the previous interrupt. Then all 4 DAC values are
; fetched and written out through the synchronous serial interface. Finally, the
; rolling pointer is incremented to address the next sample, ready for the next
; interrupt.
;
; © 1998, Texas Instruments Incorporated
;-----;
; -----I/O and memory mapped regs -----
;               .include "regs.asm"
; -----jump vectors-----
;               .ps      0h
;               b        start
;               b        int1
;               b        int23
;               b        timer_isr
;----- variables -----
temp            .equ     0060h
r_ptr           .equ     0061
iosr_stat       .equ     0062h
DACa_ptr        .equ     0063h
DACb_ptr        .equ     0064h
DACc_ptr        .equ     0065h
DACd_ptr        .equ     0066h

;----- constants -----
; DAC control bits to be OR'ed onto data
; all fast mode
DACa_control    .equ     01000h
DACb_control    .equ     05000h
DACc_control    .equ     09000h
DACd_control    .equ     0d000h
;----- tables -----
;               .ds      02000h
sinevals
;               .word    00800h
;               .word    0097Ch
;               .word    00AE9h
;               .word    00C3Ah
;               .word    00D61h
;               .word    00E53h
;               .word    00F07h
;               .word    00F76h
;               .word    00F9Ch
;               .word    00F76h
;               .word    00F07h
;               .word    00E53h
;               .word    00D61h
;               .word    00C3Ah

```

# TLV5604

## 2.7-V TO 5.5-V 10-BIT 3- $\mu$ S QUADRUPLE DIGITAL-TO-ANALOG CONVERTERS WITH POWER DOWN

SLAS176A – DECEMBER 1997 – REVISED SEPTEMBER 1998

---

### APPLICATION INFORMATION

```
.word    00AE9h
.word    0097Ch
.word    00800h
.word    00684h
.word    00517h
.word    003C6h
.word    0029Fh
.word    001ADh
.word    000F9h
.word    0008Ah
.word    00064h
.word    0008Ah
.word    000F9h
.word    001ADh
.word    0029Fh
.word    003C6h
.word    00517h
.word    00684h
.word    00800h
.word    0097Ch
.word    00AE9h
.word    00C3Ah
.word    00D61h
.word    00E53h
.word    00F07h
.word    00F76h
.word    00F9Ch
.word    00F76h
.word    00F07h
.word    00E53h
.word    00D61h
.word    00C3Ah
.word    00AE9h
.word    0097Ch
.word    00800h
.word    00684h
.word    00517h
.word    003C6h
.word    0029Fh
.word    001ADh
.word    000F9h
.word    0008Ah
.word    00064h
.word    0008Ah
.word    000F9h
.word    001ADh
.word    0029Fh
.word    003C6h
.word    00517h
.word    00684h
;-----
; Main Program
;-----
        .ps    1000h
        .entry

start
;-----
; disable interrupts
;-----
        setc   INTM           ; disable maskable interrupts
        splk  #0ffffh, IFR    ; clear all interrupts
        splk  #0004h, IMR     ; timer interrupts unmasked
```



TLV5604

## 2.7-V TO 5.5-V 10-BIT 3- $\mu$ S QUADRUPLE DIGITAL-TO-ANALOG CONVERTERS WITH POWER DOWN

SLAS176A – DECEMBER 1997 – REVISED SEPTEMBER 1998

### APPLICATION INFORMATION

```

;-----
; set up the timer
; timer period set by values in PRD and TDDR
; period = (CLKOUT1 period) × (1+PRD) × (1+TDDR)
; examples for TMS320C203 with 40 MHz main clock
; Timer rate      TDDR      PRD
; 80 kHz          9         24 (18h)
; 50 kHz          9         39 (27h)
;-----

prd_val.equ      0018h
tcr_val.equ      0029h

        splk    #0000h, temp    ; clear timer
        out     temp, TIM
        splk    #prd_val, temp   ; set PRD
        out     temp, PRD
        splk    #tcr_val, temp   ; set TDDR, and TRB=1 for auto-reload
        out     temp, TCR
;-----
; Configure IO0/1 as outputs to be :
; IO0 CS      - and set high
; IO1 LDAC    - and set high
;-----
        in      temp, ASPCR      ; configure as output
        lacl    temp
        or      #0003h
        sacl    temp
        out     temp, ASPCR
        in      temp, IOSR      ; set them high
        lacl    temp
        or      #0003h
        sacl    temp
        out     temp, IOSR
;-----
; set up serial port for
; SSPCR.TXM=1  Transmit mode - generate FSX
; SSPCR.MCM=1  Clock mode - internal clock source
; SSPCR.FSM=1  Burst mode
;-----
        splk    #0000Eh, temp
        out     temp, SSPCR      ; reset transmitter
        splk    #0002Eh, temp
        out     temp, SSPCR
;-----
; reset the rolling pointer
;-----
        lacl    #000h          sacl r_ptr
;-----
; enable interrupts
;-----
        clrc   INTM
; enable maskable interrupts
;-----
; loop forever!
;-----
next     idle          ;wait for interrupt
        b      next
;-----
; all else fails stop here
;-----
done     b            done     ;hang there

```

# TLV5604

## 2.7-V TO 5.5-V 10-BIT 3- $\mu$ S QUADRUPLE DIGITAL-TO-ANALOG CONVERTERS WITH POWER DOWN

SLAS176A – DECEMBER 1997 – REVISED SEPTEMBER 1998

### APPLICATION INFORMATION

```
-----  
; Interrupt Service Routines  
-----  
int1      ret      ; do nothing and return  
int23     ret      ; do nothing and return  
timer_isr:  
  in      iosr_stat, IOSR ; store IOSR value into variable space  
  lacl   iosr_stat      ; load acc with iosr status  
  and    #0FFFDh        ; reset IO1 - LDAC low  
  sac1   temp           ;  
  out    temp, IOSR    ;  
  
  or     #0002h         ; set IO1 - LDAC high  
  sac1   temp           ;  
  out    temp, IOSR    ;  
  and    #0FFFEh        ; reset IO0 - CS low  
  sac1   temp           ;  
  out    temp, IOSR    ;  
  lacl   r_ptr          ; load rolling pointer to accumulator  
  add    #sinevals      ; add pointer to table start  
  sac1   DACa_ptr       ; to get a pointer for next DAC a sample  
  add    #08h           ; add 8 to get to DAC C pointer  
  sac1   DACc_ptr       ;  
  add    #08h           ; add 8 to get to DAC B pointer  
  sac1   DACb_ptr       ;  
  add    #08h           ; add 8 to get to DAC D pointer  
  sac1   DACd_ptr       ;  
  mar    *,ar0          ; set ar0 as current AR  
  
  ; DAC A  
  lar    ar0, DACa_ptr ; ar0 points to DAC a sample  
  lacl   *              ; get DAC a sample into accumulator  
  or     #DACa_control ; OR in DAC A control bits  
  sac1   temp           ;  
  out    temp, SDTR    ; send data  
  
-----  
; We must wait for transmission to complete before writing next word to the SDTR.  
; TLV5604 interface does not allow the use of burst mode with the full packet rate, as  
; we need a CLKX -ve edge to clock in last bit before FS goes high again, to allow SPI  
; compatibility.  
-----  
  rpt    #016h          ; wait long enough for this configuration  
  nop                                ; of MCLK/CLKOUT1 rate  
  
  ; DAC B  
  lar    ar0, DACb_ptr ; ar0 points to DAC a sample  
  lacl   *              ; get DAC a sample into accumulator  
  or     #DACb_control ; OR in DAC B control bits  
  sac1   temp           ;  
  out    temp, SDTR    ; send data  
  rpt    #016h          ; wait long enough for this configuration  
  nop                                ; of MCLK/CLKOUT1 rate
```

TLV5604

2.7-V TO 5.5-V 10-BIT 3- $\mu$ S QUADRUPLE DIGITAL-TO-ANALOG CONVERTERS  
WITH POWER DOWN

SLAS176A – DECEMBER 1997 – REVISED SEPTEMBER 1998

**APPLICATION INFORMATION**

```
; DAC C
lar      ar0, DACc_ptr; ar0 points to DAC a sample
lacl     *           ; get DAC a sample into accumulator
or       #DACc_control; OR in DAC C control bits
sac1     temp        ;
out      temp, SDTR  ; send data
rpt      #016h       ; wait long enough for this configuration
nop      ; of MCLK/CLKOUT1 rate

; DAC D
lar      ar0, DACd_ptr; ar0 points to DAC a sample
lacl     *           ; get DAC a sample into accumulator
or       #DACd_control; OR in DAC D control bits
sac1     temp        ;
out      temp, SDTR  ; send data
lacl     r_ptr       ; load rolling pointer to accumulator
add      #1h         ; increment rolling pointer
and      #001Fh      ; count 0-31 then wrap back round
sac1     r_ptr       ; store rolling pointer
rpt      #016h       ; wait long enough for this configuration
nop      ; of MCLK/CLKOUT1 rate

; now take CS high again
lacl     iosr_stat   ; load acc with iosr status
or       #0001h      ; set IO0 - CS high
sac1     temp        ;
out      temp, IOSR  ;
clrc     intm        ; re-enable interrupts
ret      ; return from interrupt
.end
```

# TLV5604

## 2.7-V TO 5.5-V 10-BIT 3- $\mu$ S QUADRUPLE DIGITAL-TO-ANALOG CONVERTERS WITH POWER DOWN

SLAS176A – DECEMBER 1997 – REVISED SEPTEMBER 1998

### APPLICATION INFORMATION

#### TLV5604 interfaced to MCS<sup>®</sup>51 microcontroller

##### hardware interfacing

Figure 18 shows an example of how to connect the TLV5604 to an MCS<sup>®</sup>51 Microcontroller. The serial DAC input data and external control signals are sent via I/O Port 3 of the controller. The serial data is sent on the RxD line, with the serial clock output on the TxD line. Port 3 bits 3, 4, and 5 are configured as outputs to provide the DAC latch update ( $\overline{\text{LDAC}}$ ), chip select ( $\overline{\text{CS}}$ ) and frame sync (FS) signals for the TLV5604. The active low power down pin ( $\overline{\text{PD}}$ ) of the TLV5604 is pulled high to ensure that the DACs are enabled.

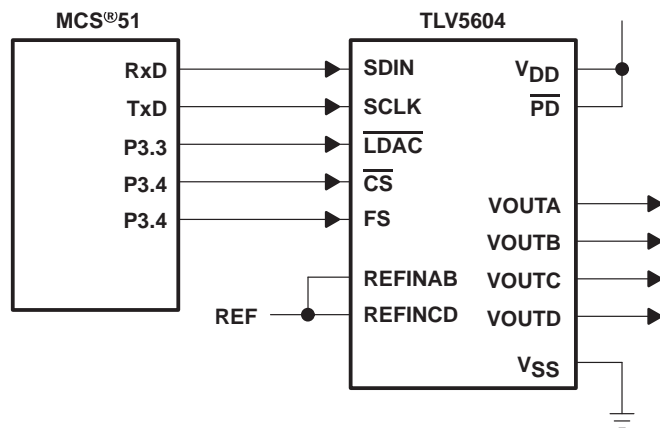

Figure 18. TLV5604 Interfaced with MCS<sup>®</sup>51

##### software

The example is the same as for the TMS320C203 in this datasheet, but adapted for a MCS<sup>®</sup>51 controller. It generates a differential in-phase (sine) signal between the VOUTA and VOUTB pins, and its quadrature (cosine) signal as the differential signal between VOUTC and VOUTD.

The on-chip timer is used to generate interrupts at a fixed frequency. The related interrupt service routine pulses  $\overline{\text{LDAC}}$  low to update all 4 DACs simultaneously, then fetches and writes the next sample to all 4 DACs. The samples are stored as a look-up table, which describes one full period of a sine wave.

The serial port of the controller is used in Mode 0, which transmits 8 bits of data on RxD, accompanied by a synchronous clock on TxD. Two writes concatenated together are required to write a complete word to the TLV5604. The  $\overline{\text{CS}}$  and FS signals are provided in the required fashion through control of IO port 3, which has bit addressable outputs.

TLV5604

## 2.7-V TO 5.5-V 10-BIT 3- $\mu$ S QUADRUPLE DIGITAL-TO-ANALOG CONVERTERS WITH POWER DOWN

SLAS176A – DECEMBER 1997 – REVISED SEPTEMBER 1998

### APPLICATION INFORMATION

```

-----
; Processor: 80C51
;
; Description:
;
; This program generates a differential in-phase (sine) on (OUTA-OUTB) and it's
; quadrature (cosine) as a differential signal on (OUTC-OUTD).
; © 1998, Texas Instruments Incorporated
-----
NAME      GENIQ
MAIN      SEGMENT  CODE
ISR       SEGMENT  CODE
SINTBL    SEGMENT  CODE
VAR1      SEGMENT  DATA
STACK     SEGMENT  IDATA
-----
; Code start at address 0, jump to start
;
          CSEG   AT 0
          LJMP   start      ; Execution starts at address 0 on power-up.
-----
; Code in the timer0 interrupt vector
;
          CSEG   AT 0BH
          LJMP   timer0isr ; Jump vector for timer 0 interrupt is 000Bh
-----
; Global variables need space allocated
;
          RSEG   VAR1
Temp_ptr: DS      1
rolling_ptr: DS   1
-----
; Interrupt service routine for timer 0 interrupts
;
timer0isr: RSEG   ISR
           PUSH  PSW
           PUSH  ACC

           CLR   INT1      ; pulse LDAC low
           SETB  INT1      ; to latch all 4 previous values at the same time
                           ; 1st thing done in timer isr => fixed period

           CLR   T0        ; set CS low
; The signal to be output on each DAC is a sine function.
; One cycle of a sine wave is held in a table @ sinevals as 32 samples of msb,
; lsb pairs (64 bytes). We have one pointer which rolls round this table,
; rolling_ptr, incrementing by 2 bytes (1 sample) on each interrupt (at the end of
; this routine).

; The DAC samples are read at an offset to this rolling pointer:
; DAC Function Offset from rolling_ptr
; A sine          0
; B inverse sine  32
; C cosine        16
; D inverse cosine 48
MOV  DPTR,#sinevals ; set DPTR to the start of the table of sine signal values
MOV  R7,rolling_ptr ; R7 holds the pointer into the sine table
MOV  A,R7           ; get DAC A msb
MOVC A,@A+DPTR     ; msb of DAC A is in the ACC
CLR  T1            ; transmit it - set FS low
MOV  SBUF,A        ; send it out the serial port
INC  R7            ; increment the pointer in R7
MOV  A,R7          ; to get the next byte from the table
MOVC A,@A+DPTR     ; which is the lsb of this sample, now in ACC

```

# TLV5604

## 2.7-V TO 5.5-V 10-BIT 3- $\mu$ S QUADRUPLE DIGITAL-TO-ANALOG CONVERTERS WITH POWER DOWN

SLAS176A – DECEMBER 1997 – REVISED SEPTEMBER 1998

### APPLICATION INFORMATION

```
A_MSB_TX:
  JNB  TI,A_MSB_TX  ; wait for transmit to complete
  CLR  TI           ; clear for new transmit
  MOV  SBUF,A       ; and send out the lsb of DAC A

  ; DAC C next
  ; DAC C codes should be taken from 16 bytes (8 samples) further on in the sine table
  ; - this gives a cosine function
  MOV  A,R7         ; pointer in R7
  ADD  A,#0FH       ; add 15 - already done one INC
  ANL  A,#03FH      ; wrap back round to 0 if > 64
  MOV  R7,A         ; pointer back in R7

  MOVC A,@A+DPTR    ; get DAC C msb from the table
  ORL  A,#01H       ; set control bits to DAC C address

A_LSB_TX:
  JNB  TI,A_LSB_TX  ; wait for DAC A lsb transmit to complete
  SETB T1           ; toggle FS
  CLR  T1
  CLR  TI           ; clear for new transmit
  MOV  SBUF,A       ; and send out the msb of DAC C

  INC  R7           ; increment the pointer in R7
  MOV  A,R7         ; to get the next byte from the table
  MOVC A,@A+DPTR    ; which is the lsb of this sample, now in ACC

C_MSB_TX:
  JNB  TI,C_MSB_TX  ; wait for transmit to complete
  CLR  TI           ; clear for new transmit
  MOV  SBUF,A       ; and send out the lsb of DAC C

  ; DAC B next
  ; DAC B codes should be taken from 16 bytes (8 samples) further on
  ; in the sine table - this gives an inverted sine function
  MOV  A,R7         ; pointer in R7
  ADD  A,#0FH       ; add 15 - already done one INC
  ANL  A,#03FH      ; wrap back round to 0 if > 64
  MOV  R7,A         ; pointer back in R7

  MOVC A,@A+DPTR    ; get DAC B msb from the table
  ORL  A,#02H       ; set control bits to DAC B address

C_LSB_TX:
  JNB  TI,C_LSB_TX  ; wait for DAC C lsb transmit to complete
  SETB T1           ; toggle FS
  CLR  T1
  CLR  TI           ; clear for new transmit
  MOV  SBUF,A       ; and send out the msb of DAC B
  ; get DAC B LSB

  INC  R7           ; increment the pointer in R7
  MOV  A,R7         ; to get the next byte from the table
  MOVC A,@A+DPTR    ; which is the lsb of this sample, now in ACC

B_MSB_TX:
  JNB  TI,B_MSB_TX  ; wait for transmit to complete
  CLR  TI           ; clear for new transmit
  MOV  SBUF,A       ; and send out the lsb of DAC B
```

TLV5604

## 2.7-V TO 5.5-V 10-BIT 3- $\mu$ S QUADRUPLE DIGITAL-TO-ANALOG CONVERTERS WITH POWER DOWN

SLAS176A – DECEMBER 1997 – REVISED SEPTEMBER 1998

### APPLICATION INFORMATION

```

; DAC D next
; DAC D codes should be taken from 16 bytes (8 samples) further on in the sine table
; - this gives an inverted cosine function
MOV   A,R7           ; pointer in R7
ADD   A,#0FH        ; add 15 - already done one INC
ANL   A,#03FH       ; wrap back round to 0 if > 64
MOV   R7,A          ; pointer back in R7

MOVC  A,@A+DPTR     ; get DAC D msb from the table
ORL   A,#03H        ; set control bits to DAC D address

B_LSB_TX:
JNB   TI,B_LSB_TX   ; wait for DAC B lsb transmit to complete
SETB  T1            ; toggle FS
CLR   T1
CLR   TI            ; clear for new transmit
MOV   SBUF,A        ; and send out the msb of DAC D

INC   R7            ; increment the pointer in R7
MOV   A,R7          ; to get the next byte from the table
MOVC  A,@A+DPTR     ; which is the lsb of this sample, now in ACC

D_MSB_TX:
JNB   TI,D_MSB_TX   ; wait for transmit to complete
CLR   TI            ; clear for new transmit
MOV   SBUF,A        ; and send out the lsb of DAC D

; increment the rolling pointer to point to the next sample
; ready for the next interrupt
MOV   A,rolling_ptr
ADD   A,#02H        ; add 2 to the rolling pointer
ANL   A,#03FH       ; wrap back round to 0 if > 64
MOV   rolling_ptr,A ; store in memory again

D_LSB_TX:
JNB   TI,D_LSB_TX   ; wait for DAC D lsb transmit to complete
CLR   TI            ; clear for next transmit

SETB  T1            ; FS high
SETB  T0            ; CS high
POP   ACC
POP   PSW

RETI

;-----
; Stack needs definition
;-----
RSEG  STACK
DS    10h           ; 16 Byte Stack!

```

# TLV5604

## 2.7-V TO 5.5-V 10-BIT 3- $\mu$ S QUADRUPLE DIGITAL-TO-ANALOG CONVERTERS WITH POWER DOWN

SLAS176A – DECEMBER 1997 – REVISED SEPTEMBER 1998

### APPLICATION INFORMATION

```
-----  
; Main program code  
-----  
RSEG MAIN  
start:  
MOV SP,#STACK-1 ; first set Stack Pointer  
  
CLR A  
MOV SCON,A ; set serial port 0 to mode 0  
MOV TMOD,#02H ; set timer 0 to mode 2 - auto-reload  
MOV TH0,#038H ; set TH0 for 5 kHs interrupts  
  
SETB INT1 ; set LDAC = 1  
SETB T1 ; set FS = 1  
SETB T0 ; set CS = 1  
  
SETB ET0 ; enable timer 0 interrupts  
SETB EA ; enable all interrupts  
  
MOV rolling_ptr,A ; set rolling pointer to 0  
SETB TR0 ; start timer 0  
  
always:  
JMP always ; while(1) !  
RET  
-----  
; Table of 32 sine wave samples used as DAC data  
-----  
RSEG SINTBL  
sinevals:  
DW 01000H  
DW 0903EH  
DW 05097H  
DW 0305CH  
DW 0B086H  
DW 070CAH  
DW 0F0E0H  
DW 0F06EH  
DW 0F039H  
DW 0F06EH  
DW 0F0E0H  
DW 070CAH  
DW 0B086H  
DW 0305CH  
DW 05097H  
DW 0903EH  
DW 01000H  
DW 06021H  
DW 0A0E8H  
DW 0C063H  
DW 040F9H  
DW 080B5H  
DW 0009FH  
DW 00051H  
DW 00026H  
DW 00051H  
DW 0009FH  
DW 080B5H  
DW 040F9H  
DW 0C063H  
DW 0A0E8H  
DW 06021H  
  
END
```



TLV5604  
**2.7-V TO 5.5-V 10-BIT 3- $\mu$ S QUADRUPLE DIGITAL-TO-ANALOG CONVERTERS  
 WITH POWER DOWN**

SLAS176A – DECEMBER 1997 – REVISED SEPTEMBER 1998

**MECHANICAL DATA**

**D (R-PDSO-G\*\*)**

**PLASTIC SMALL-OUTLINE PACKAGE**

14 PIN SHOWN

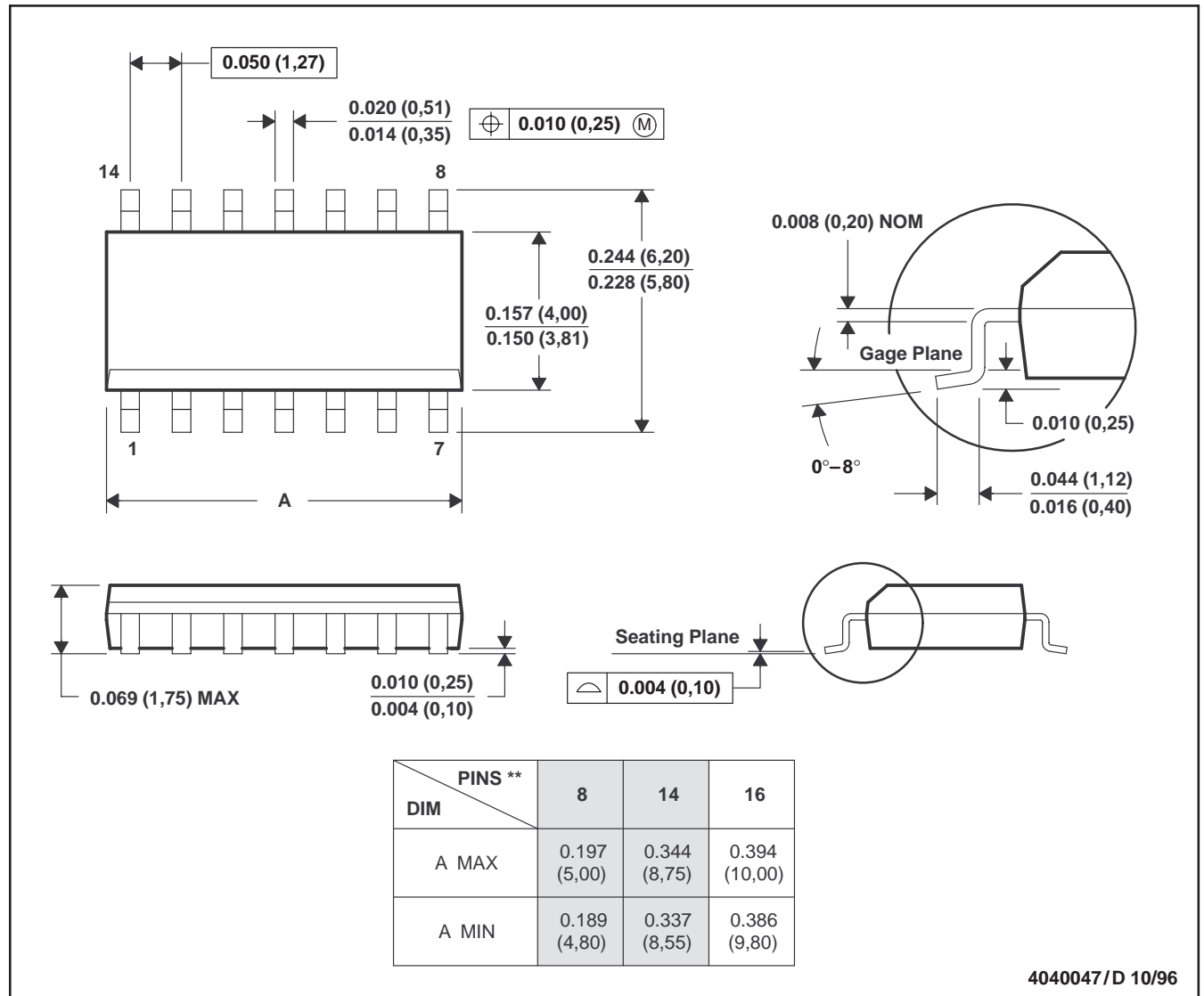

- NOTES: A. All linear dimensions are in inches (millimeters).  
 B. This drawing is subject to change without notice.  
 C. Body dimensions do not include mold flash or protrusion, not to exceed 0.006 (0,15).  
 D. Falls within JEDEC MS-012

**TLV5604**  
**2.7-V TO 5.5-V 10-BIT 3- $\mu$ S QUADRUPLE DIGITAL-TO-ANALOG CONVERTERS**  
**WITH POWER DOWN**

SLAS176A – DECEMBER 1997 – REVISED SEPTEMBER 1998

**MECHANICAL DATA**

**PW (R-PDSO-G\*\*)**

**PLASTIC SMALL-OUTLINE PACKAGE**

14 PIN SHOWN

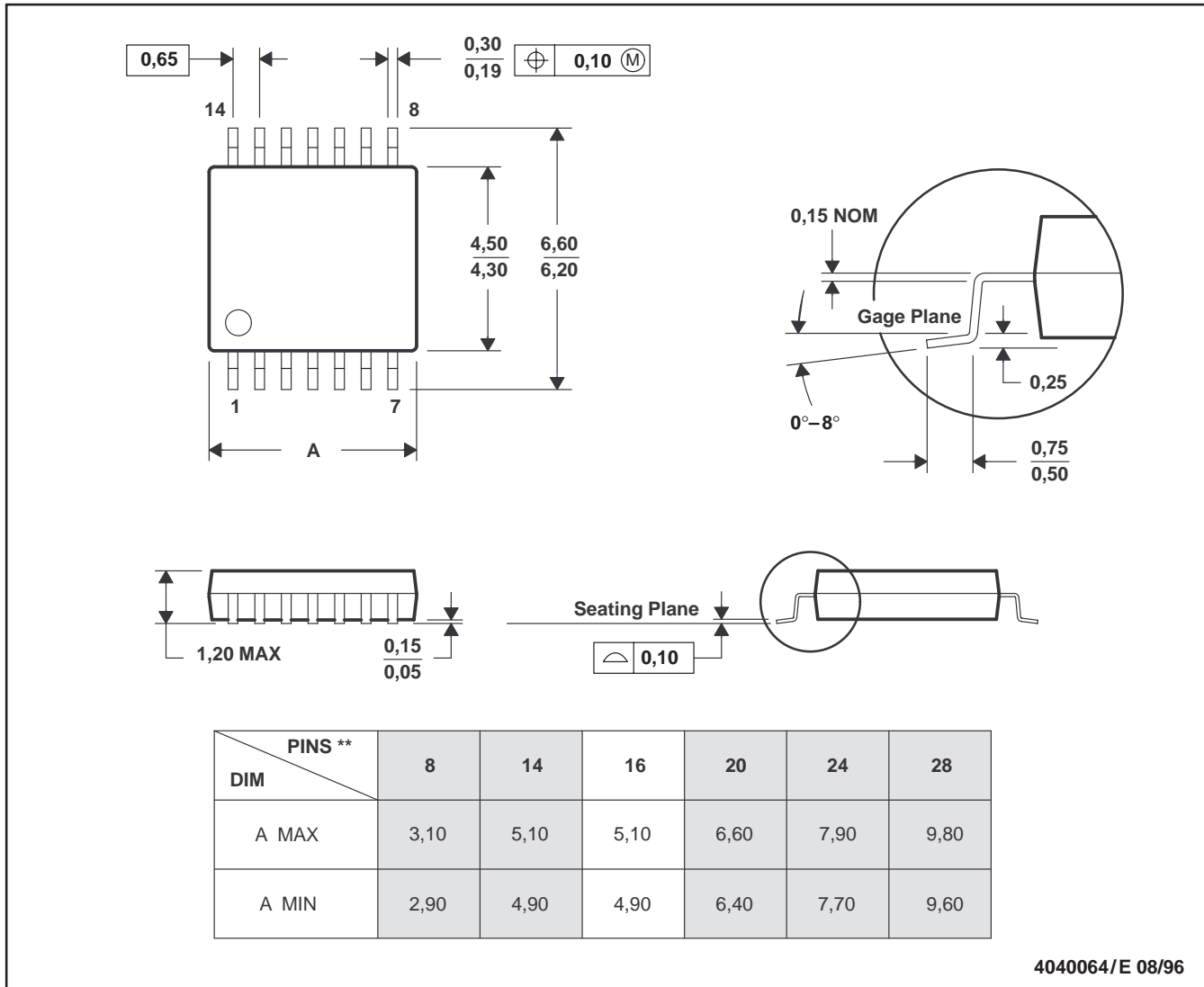

4040064/E 08/96

- NOTES: A. All linear dimensions are in millimeters.  
 B. This drawing is subject to change without notice.  
 C. Body dimensions do not include mold flash or protrusion not to exceed 0,15.  
 D. Falls within JEDEC MO-153

## **IMPORTANT NOTICE**

Texas Instruments and its subsidiaries (TI) reserve the right to make changes to their products or to discontinue any product or service without notice, and advise customers to obtain the latest version of relevant information to verify, before placing orders, that information being relied on is current and complete. All products are sold subject to the terms and conditions of sale supplied at the time of order acknowledgement, including those pertaining to warranty, patent infringement, and limitation of liability.

TI warrants performance of its semiconductor products to the specifications applicable at the time of sale in accordance with TI's standard warranty. Testing and other quality control techniques are utilized to the extent TI deems necessary to support this warranty. Specific testing of all parameters of each device is not necessarily performed, except those mandated by government requirements.

**CERTAIN APPLICATIONS USING SEMICONDUCTOR PRODUCTS MAY INVOLVE POTENTIAL RISKS OF DEATH, PERSONAL INJURY, OR SEVERE PROPERTY OR ENVIRONMENTAL DAMAGE ("CRITICAL APPLICATIONS"). TI SEMICONDUCTOR PRODUCTS ARE NOT DESIGNED, AUTHORIZED, OR WARRANTED TO BE SUITABLE FOR USE IN LIFE-SUPPORT DEVICES OR SYSTEMS OR OTHER CRITICAL APPLICATIONS. INCLUSION OF TI PRODUCTS IN SUCH APPLICATIONS IS UNDERSTOOD TO BE FULLY AT THE CUSTOMER'S RISK.**

In order to minimize risks associated with the customer's applications, adequate design and operating safeguards must be provided by the customer to minimize inherent or procedural hazards.

TI assumes no liability for applications assistance or customer product design. TI does not warrant or represent that any license, either express or implied, is granted under any patent right, copyright, mask work right, or other intellectual property right of TI covering or relating to any combination, machine, or process in which such semiconductor products or services might be or are used. TI's publication of information regarding any third party's products or services does not constitute TI's approval, warranty or endorsement thereof.