

LM2900, LM3900 QUADRUPLE NORTON OPERATIONAL AMPLIFIERS

SLOS059 – JULY 1979 – REVISED SEPTEMBER 1990

- **Wide Range of Supply Voltages, Single or Dual Supplies**
- **Wide Bandwidth**
- **Large Output Voltage Swing**
- **Output Short-Circuit Protection**
- **Internal Frequency Compensation**
- **Low Input Bias Current**
- **Designed to Be Interchangeable With National Semiconductor LM2900 and LM3900, Respectively**

N PACKAGE
(TOP VIEW)

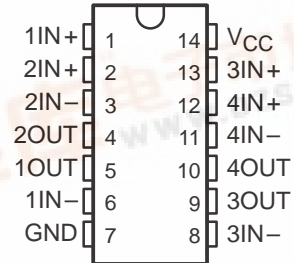

description

These devices consist of four independent, high-gain frequency-compensated Norton operational amplifiers that were designed specifically to operate from a single supply over a wide range of voltages. Operation from split supplies is also possible. The low supply current drain is essentially independent of the magnitude of the supply voltage. These devices provide wide bandwidth and large output voltage swing.

The LM2900 is characterized for operation from -40°C to 85°C , and the LM3900 is characterized for operation from 0°C to 70°C .

symbol (each amplifier)

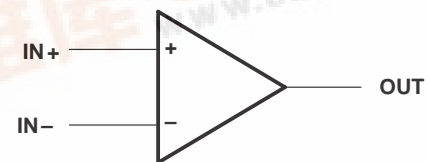

schematic (each amplifier)

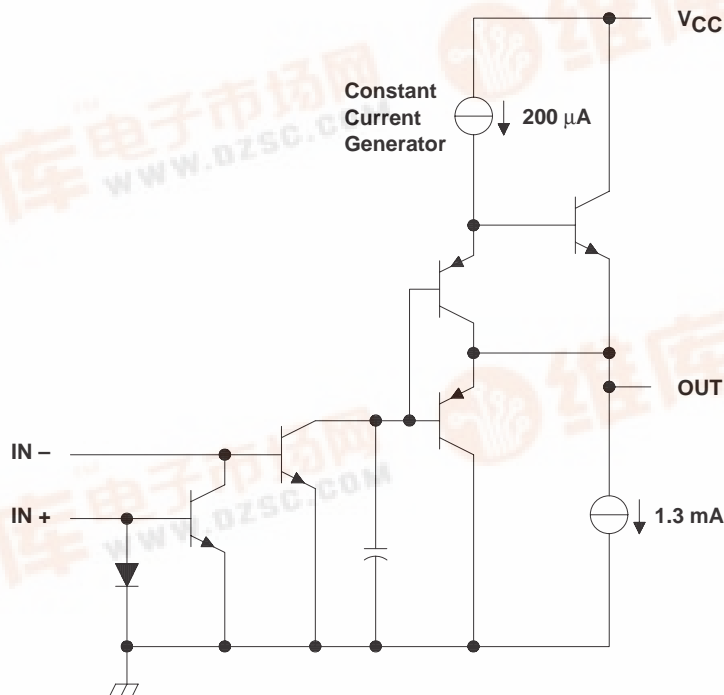

LM2900, LM3900

QUADRUPLE NORTON OPERATIONAL AMPLIFIERS

SLOS059 – JULY 1979 – REVISED SEPTEMBER 1990

absolute maximum ratings over operating free-air temperature range (unless otherwise noted)

	LM2900	LM3900	UNIT
Supply voltage, V_{CC} (see Note 1)	36	36	V
Input current	20	20	mA
Duration of output short circuit (one amplifier) to ground at (or below) 25°C free-air temperature (see Note 2)	unlimited	unlimited	
Continuous total dissipation	See Dissipation Rating Table		
Operating free-air temperature range	-40 to 85	0 to 70	°C
Storage temperature range	-65 to 150	-65 to 150	°C
Lead temperature 1,6 mm (1/16 inch) from case for 10 seconds	260	260	°C

- NOTES: 1. All voltage values, except differential voltages, are with respect to the network ground terminal.
 2. Short circuits from outputs to V_{CC} can cause excessive heating and eventual destruction.

DISSIPATION RATING TABLE

PACKAGE	$T_A \leq 25^\circ\text{C}$ POWER RATING	DERATING FACTOR ABOVE $T_A = 25^\circ\text{C}$	$T_A = 70^\circ\text{C}$ POWER RATING	$T_A = 85^\circ\text{C}$ POWER RATING
N	1150 mW	9.2 mW/°C	736 mW	598 mW

recommended operating conditions

	LM2900		LM3900		UNIT
	MIN	MAX	MIN	MAX	
Supply voltage, V_{CC} (single supply)	4.5	32	4.5	32	V
Supply voltage, V_{CC+} (dual supply)	2.2	16	2.2	16	V
Supply voltage, V_{CC-} (dual supply)	-2.2	-16	-2.2	-16	V
Input current (see Note 3)		-1		-1	mA
Operating free-air temperature, T_A	-40	85	0	70	°C

NOTE 3: Clamp transistors are included that prevent the input voltages from swinging below ground more than approximately -0.3 V. The negative input currents that may result from large signal overdrive with capacitive input coupling must be limited externally to values of approximately -1 mA. Negative input currents in excess of -4 mA causes the output voltage to drop to a low voltage. These values apply for any one of the input terminals. If more than one of the input terminals are simultaneously driven negative, maximum currents are reduced. Common-mode current biasing can be used to prevent negative input voltages.

LM2900, LM3900

QUADRUPLE NORTON OPERATIONAL AMPLIFIERS

SLOS059 – JULY 1979 – REVISED SEPTEMBER 1990

electrical characteristics, $V_{CC} = 15\text{ V}$, $T_A = 25^\circ\text{C}$ (unless otherwise noted)

PARAMETER	TEST CONDITION†	LM2900			LM3900			UNIT
		MIN	TYP	MAX	MIN	TYP	MAX	
I_{IB} Input bias current (inverting input)	$I_{I+} = 0$	$T_A = 25^\circ\text{C}$		30	200	30	200	nA
		$T_A = \text{Full range}$		300		300		
Mirror gain	$I_{I+} = 20\ \mu\text{A}$ to $200\ \mu\text{A}$ $T_A = \text{Full range}$, See Note 4	0.9		1.1	0.9		1.1	$\mu\text{A}/\mu\text{A}$
Change in mirror gain		2%		5%	2%		5%	
Mirror current	$V_{I+} = V_{I-}$, See Note 4	$T_A = \text{Full range}$,		10	500	10	500	μA
A_{VD} Large-signal differential voltage amplification	$V_O = 10\text{ V}$, $f = 100\text{ Hz}$	$R_L = 10\text{ k}\Omega$,		1.2	2.8	1.2	2.8	V/mV
r_i Input resistance (inverting input)		1			1			M Ω
r_o Output resistance		8			8			k Ω
B_1 Unity-gain bandwidth (inverting input)		2.5			2.5			MHz
k_{SVR} Supply voltage rejection ratio ($\Delta V_{CC}/\Delta V_{IO}$)		70			70			dB
V_{OH} High-level output voltage	$I_{I+} = 0$, $I_{I-} = 0$	$R_L = 2\text{ k}\Omega$		13.5		13.5		V
		$V_{CC} = 30\text{ V}$, No load		29.5		29.5		
V_{OL} Low-level output voltage	$I_{I+} = 0$, $R_L = 2\text{ k}\Omega$	$I_{I-} = 10\ \mu\text{A}$,		0.09	0.2	0.09	0.2	V
I_{OS} Short-circuit output current (output internally high)	$I_{I+} = 0$, $V_O = 0$	$I_{I-} = 0$,		-6	-18	-6	-10	mA
				0.5	1.3	0.5	1.3	
I_{OL} Low-level output current‡	$I_{I-} = 5\ \mu\text{A}$	$V_{OL} = 1\text{ V}$		5		5		mA
I_{CC} Supply current (four amplifiers)	No load			6.2	10	6.2	10	mA

† All characteristics are measured under open-loop conditions with zero common-mode voltage unless otherwise specified. Full range for T_A is -40°C to 85°C for LM2900 and 0°C to 70°C for LM3900.

‡ The output current-sink capability can be increased for large-signal conditions by overdriving the inverting input.

NOTE 4: These parameters are measured with the output balanced midway between V_{CC} and GND.

operating characteristics, $V_{CC\pm} = \pm 15\text{ V}$, $T_A = 25^\circ\text{C}$

PARAMETER		TEST CONDITIONS			MIN	TYP	MAX	UNIT
SR	Slew rate at unity gain	Low-to-high output	$V_O = 10\text{ V}$,	$C_L = 100\text{ pF}$,	$R_L = 2\text{ k}\Omega$	0.5		V/ μs
	High-to-low output	20						

LM2900, LM3900 QUADRUPLE NORTON OPERATIONAL AMPLIFIERS

SLOS059 – JULY 1979 – REVISED SEPTEMBER 1990

TYPICAL CHARACTERISTICS†

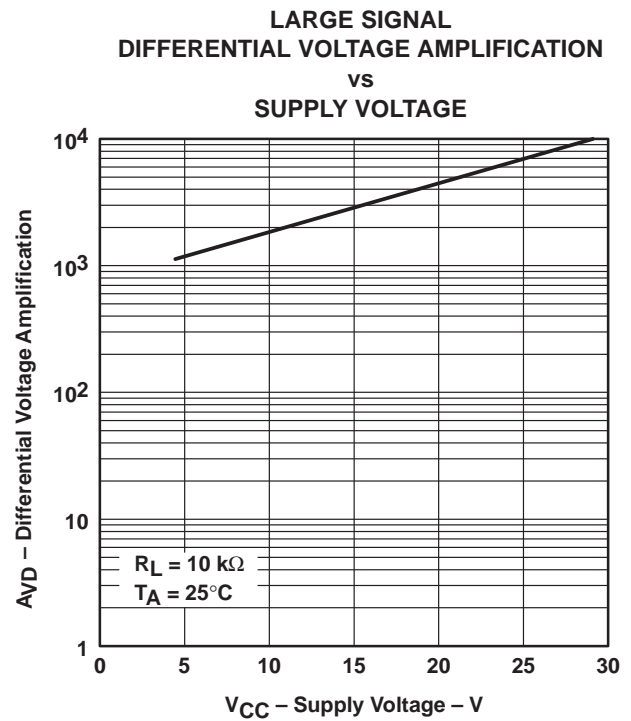
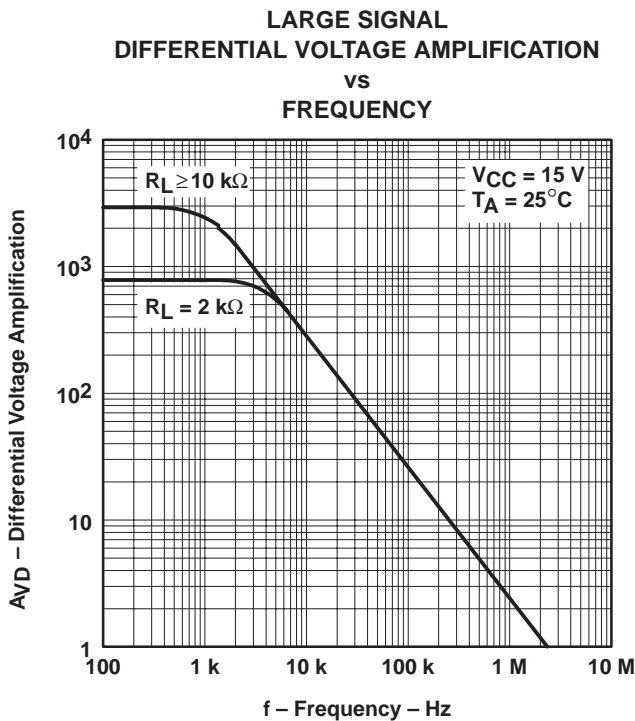
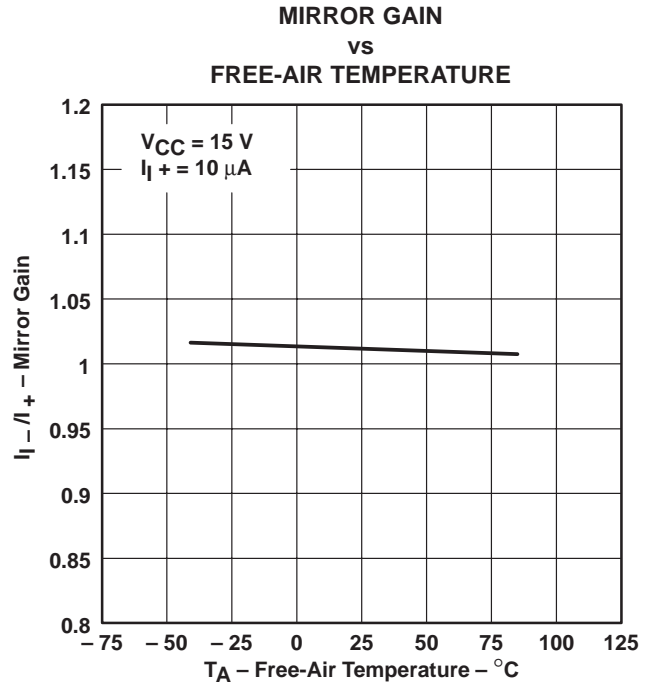
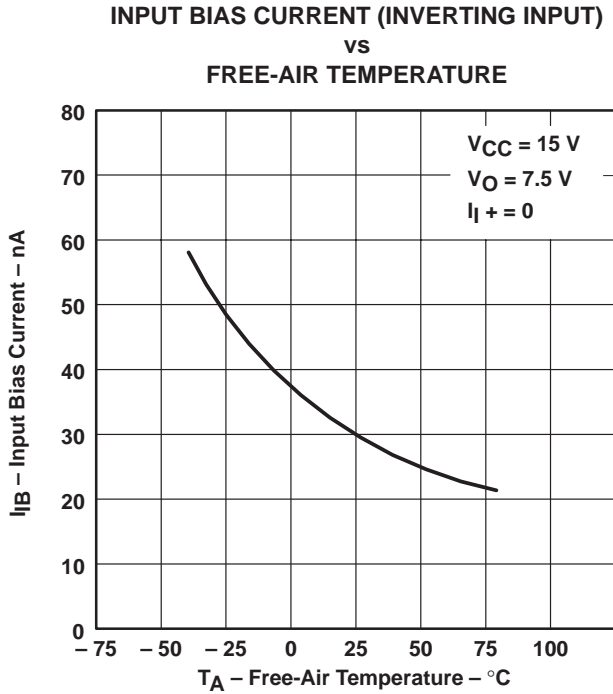

† Data at high and low temperatures are applicable only within the rated operating free-air temperature ranges of the various devices.

LM2900, LM3900 QUADRUPLE NORTON OPERATIONAL AMPLIFIERS

SLOS059 – JULY 1979 – REVISED SEPTEMBER 1990

TYPICAL CHARACTERISTICS†

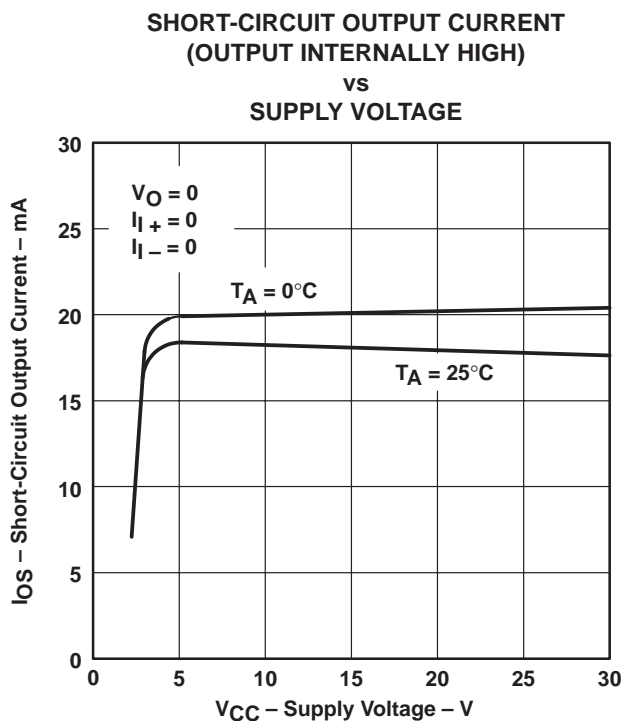
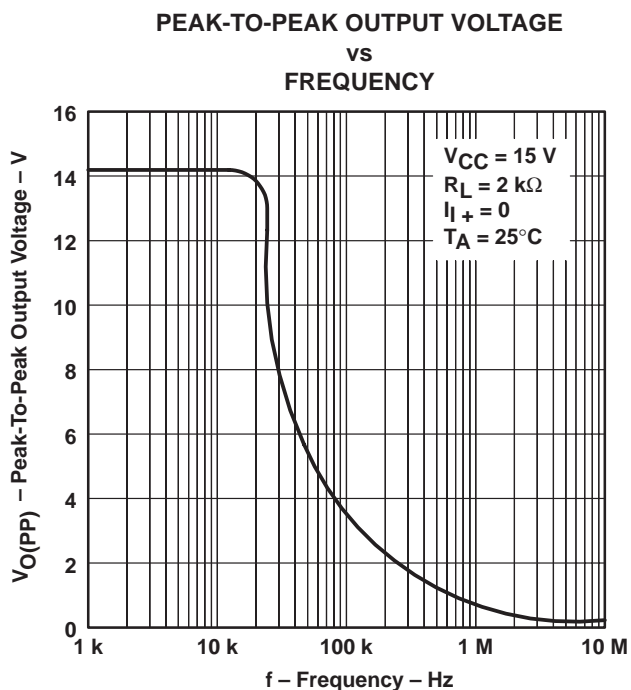
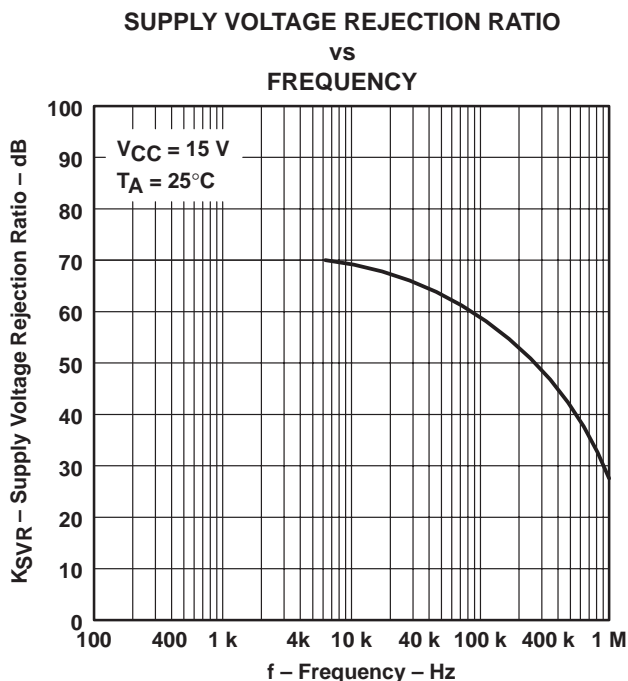
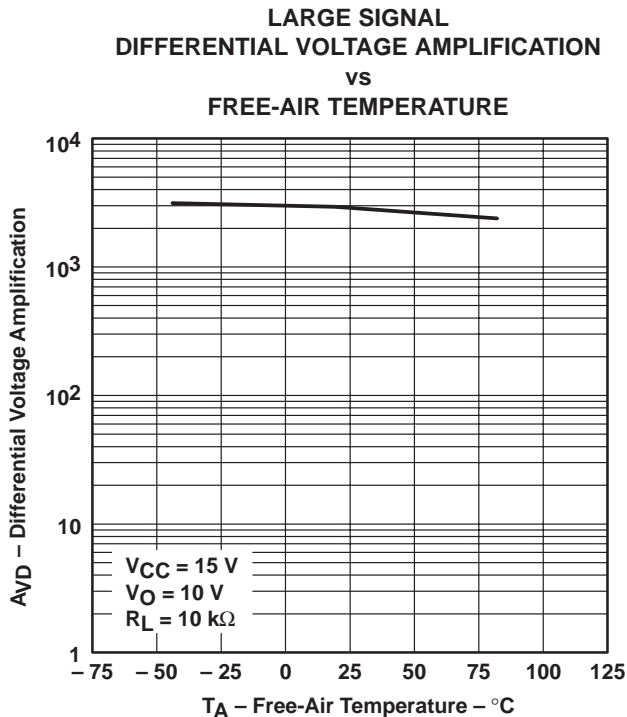

† Data at high and low temperatures are applicable only within the rated operating free-air temperature ranges of the various devices.

LM2900, LM3900 QUADRUPLE NORTON OPERATIONAL AMPLIFIERS

SLOS059 – JULY 1979 – REVISED SEPTEMBER 1990

TYPICAL CHARACTERISTICS†

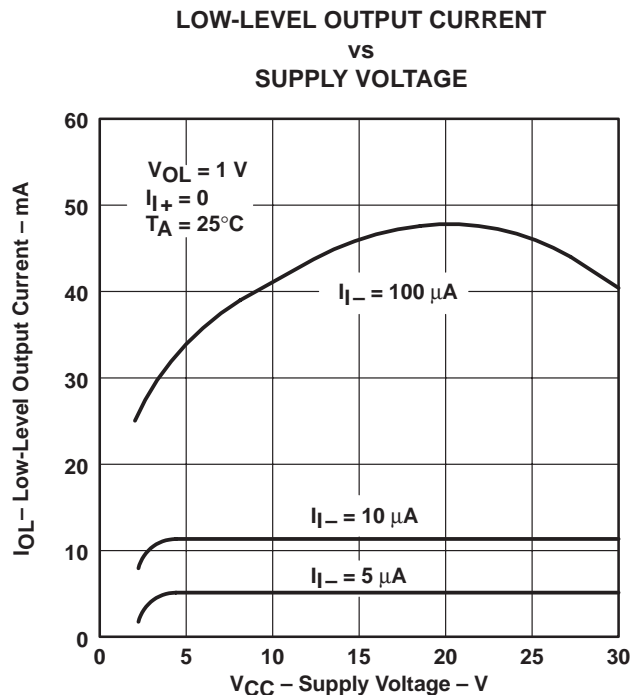

Figure 9

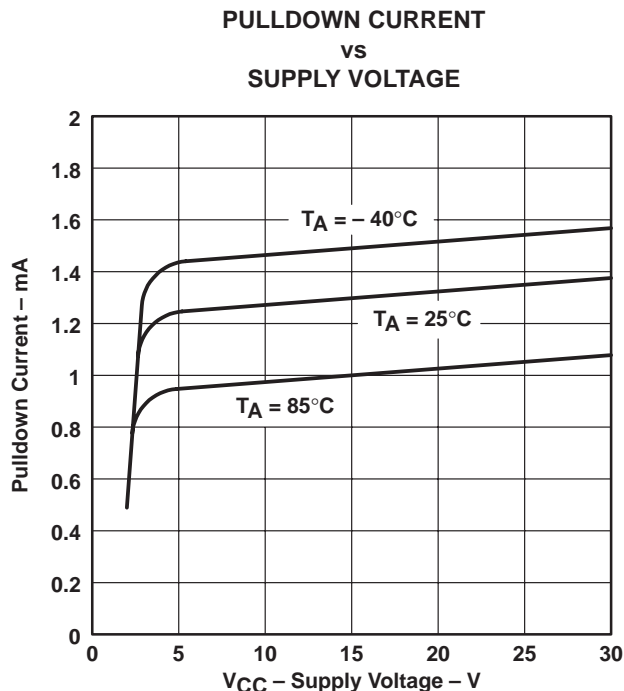

Figure 10

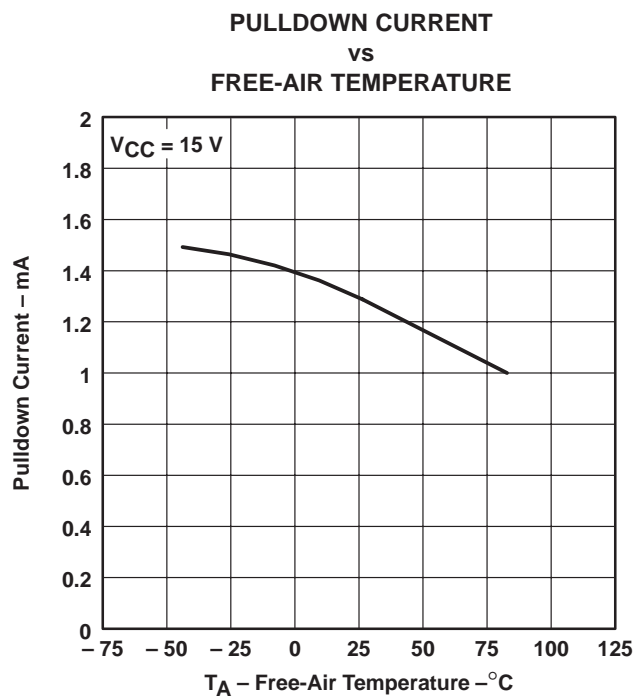

Figure 11

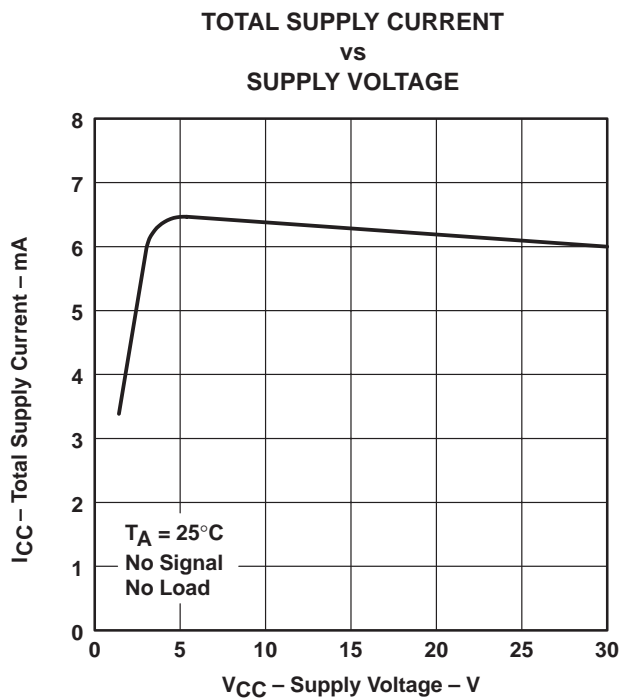

Figure 12

† Data at high and low temperatures are applicable only within the rated operating free-air temperature ranges of the various devices.

LM2900, LM3900

QUADRUPLE NORTON OPERATIONAL AMPLIFIERS

SLOS059 – JULY 1979 – REVISED SEPTEMBER 1990

APPLICATION INFORMATION

Norton (or current-differencing) amplifiers can be used in most standard general-purpose operational amplifier applications. Performance as a dc amplifier in a single-power-supply mode is not as precise as a standard integrated-circuit operational amplifier operating from dual supplies. Operation of the amplifier can best be understood by noting that input currents are differenced at the inverting input terminal and this current then flows through the external feedback resistor to produce the output voltage. Common-mode current biasing is generally useful to allow operating with signal levels near (or even below) ground.

Internal transistors clamp negative input voltages at approximately -0.3 V but the magnitude of current flow has to be limited by the external input network. For operation at high temperature, this limit should be approximately $-100\ \mu\text{A}$.

Noise immunity of a Norton amplifier is less than that of standard bipolar amplifiers. Circuit layout is more critical since coupling from the output to the noninverting input can cause oscillations. Care must also be exercised when driving either input from a low-impedance source. A limiting resistor should be placed in series with the input lead to limit the peak input current. Current up to $20\ \text{mA}$ will not damage the device, but the current mirror on the noninverting input will saturate and cause a loss of mirror gain at higher current levels, especially at high operating temperatures.

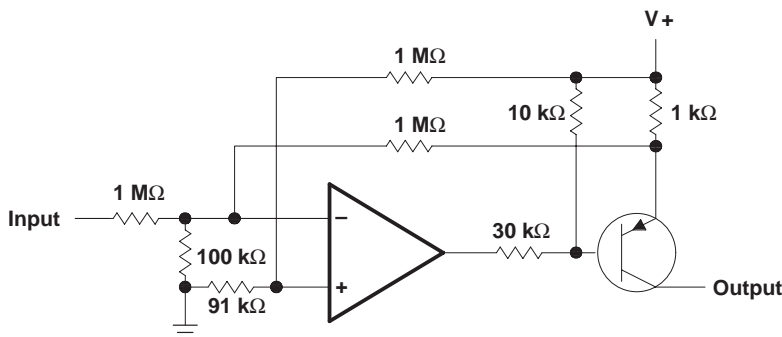

$I_O \approx 1\ \text{mA per input volt}$

Figure 13. Voltage-Controlled Current Source

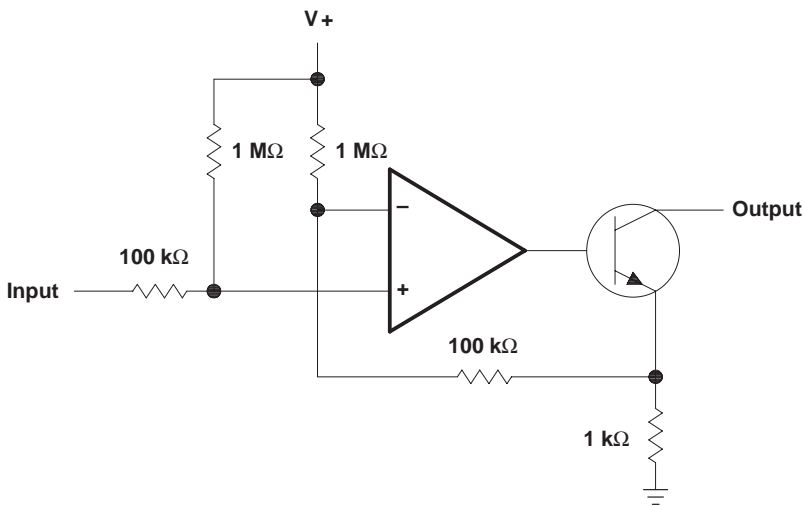

$I_O \approx 1\ \text{mA per input volt}$

Figure 14. Voltage-Controlled Current Sink

IMPORTANT NOTICE

Texas Instruments and its subsidiaries (TI) reserve the right to make changes to their products or to discontinue any product or service without notice, and advise customers to obtain the latest version of relevant information to verify, before placing orders, that information being relied on is current and complete. All products are sold subject to the terms and conditions of sale supplied at the time of order acknowledgement, including those pertaining to warranty, patent infringement, and limitation of liability.

TI warrants performance of its semiconductor products to the specifications applicable at the time of sale in accordance with TI's standard warranty. Testing and other quality control techniques are utilized to the extent TI deems necessary to support this warranty. Specific testing of all parameters of each device is not necessarily performed, except those mandated by government requirements.

CERTAIN APPLICATIONS USING SEMICONDUCTOR PRODUCTS MAY INVOLVE POTENTIAL RISKS OF DEATH, PERSONAL INJURY, OR SEVERE PROPERTY OR ENVIRONMENTAL DAMAGE ("CRITICAL APPLICATIONS"). TI SEMICONDUCTOR PRODUCTS ARE NOT DESIGNED, AUTHORIZED, OR WARRANTED TO BE SUITABLE FOR USE IN LIFE-SUPPORT DEVICES OR SYSTEMS OR OTHER CRITICAL APPLICATIONS. INCLUSION OF TI PRODUCTS IN SUCH APPLICATIONS IS UNDERSTOOD TO BE FULLY AT THE CUSTOMER'S RISK.

In order to minimize risks associated with the customer's applications, adequate design and operating safeguards must be provided by the customer to minimize inherent or procedural hazards.

TI assumes no liability for applications assistance or customer product design. TI does not warrant or represent that any license, either express or implied, is granted under any patent right, copyright, mask work right, or other intellectual property right of TI covering or relating to any combination, machine, or process in which such semiconductor products or services might be or are used. TI's publication of information regarding any third party's products or services does not constitute TI's approval, warranty or endorsement thereof.