

- **2.5-V Virtual Ground for 5-V/GND Analog Systems**
- **Self-Contained in Small-Outline, Dual-In-Line or 3-Terminal TO-226AA Packages**
- **High Output-Current Capability Sink or Source . . . 20 mA Typ**
- **Micropower Operation . . . 170 μ A Typ**

- **Excellent Regulation Characteristics**
 - **Output Regulation**
 –45 μ V Typ at $I_O = 0$ to –10 mA
 +15 μ V Typ at $I_O = 0$ to +10 mA
 - **Input Regulation = 1.5 μ V/V Typ**
- **Low-Impedance Output . . . 0.0075 Ω Typ**
- **Macromodel Included**

description

In signal-conditioning applications using a single power source, a reference voltage is required for termination of all signal grounds. To accomplish this, engineers have typically used solutions consisting of resistors, capacitors, operational amplifiers, and voltage references. Texas Instruments has eliminated all of those components with one easy-to-use 3-terminal device. That device is the TLE2425 precision virtual ground.

Use of the TLE2425 over other typical circuit solutions gives the designer increased dynamic signal range, improved signal-to-noise ratio, lower distortion, improved signal accuracy, and easier interfacing to ADCs and DACs. These benefits are the result of combining a precision micropower voltage reference and a high-performance precision operational amplifier in a single silicon chip. It is the precision and performance of these two circuit functions together that yield such dramatic system-level performance.

The TLE2425 improves input regulation as well as output regulation and, in addition, reduces output impedance and power dissipation in a majority of virtual-ground-generation circuits. Both input regulation and load regulation exceed 12 bits of accuracy on a single 5-V system. Signal-conditioning front ends of data acquisition systems that push 12 bits and beyond can use the TLE2425 to eliminate a major source of system error.

The TLE2425C is characterized for operation from 0°C to 70°C. The TLE2425I is characterized for operation from –40°C to 85°C. The TLE2425M is characterized for operation over the full military temperature range of –55°C to 125°C.

OUTPUT REGULATION

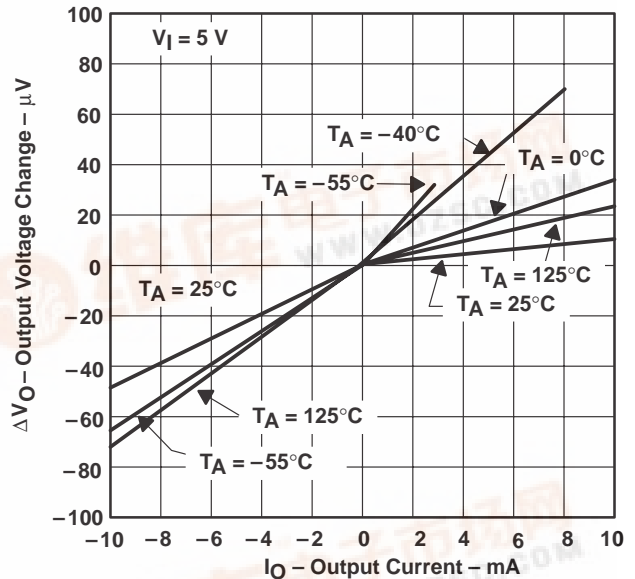

AVAILABLE OPTIONS

T _A	PACKAGED DEVICES			CHIP FORM (Y)
	SMALL OUTLINE (D)	CERAMIC DIP (JG)	PLASTIC TO-226AA (LP)	
0°C to 70°C	TLE2425CD	—	TLE2425CD	TLE2425Y
–40°C to 85°C	TLE2425ID	—	TLE2425ID	—
–55°C to 125°C	TLE2425MD	TLE2425MD	TLE2425MD	—

† The D and LP packages are available taped and reeled in the commercial temperature range only. Add R suffix to the device type (e.g., TLE2425CDR). The chip form is tested at 25°C.

Please be aware that an important notice concerning availability, standard warranty, and use in critical applications of Texas Instruments semiconductor products and disclaimers thereto appears at the end of this data sheet.

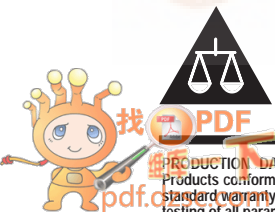

TLE2425, TLE2425Y PRECISION VIRTUAL GROUND

SLOS065C – MARCH 1991 – REVISED MAY 1998

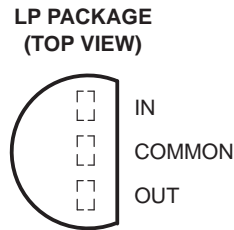
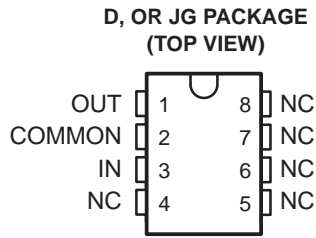

NC – No internal connection

TLE2425Y chip information

This chip, properly assembled, displays characteristics similar to the TLE2425C. Thermal compression or ultrasonic bonding may be used on the doped aluminum bonding pads. The chip may be mounted with conductive epoxy or a gold-silicon preform.

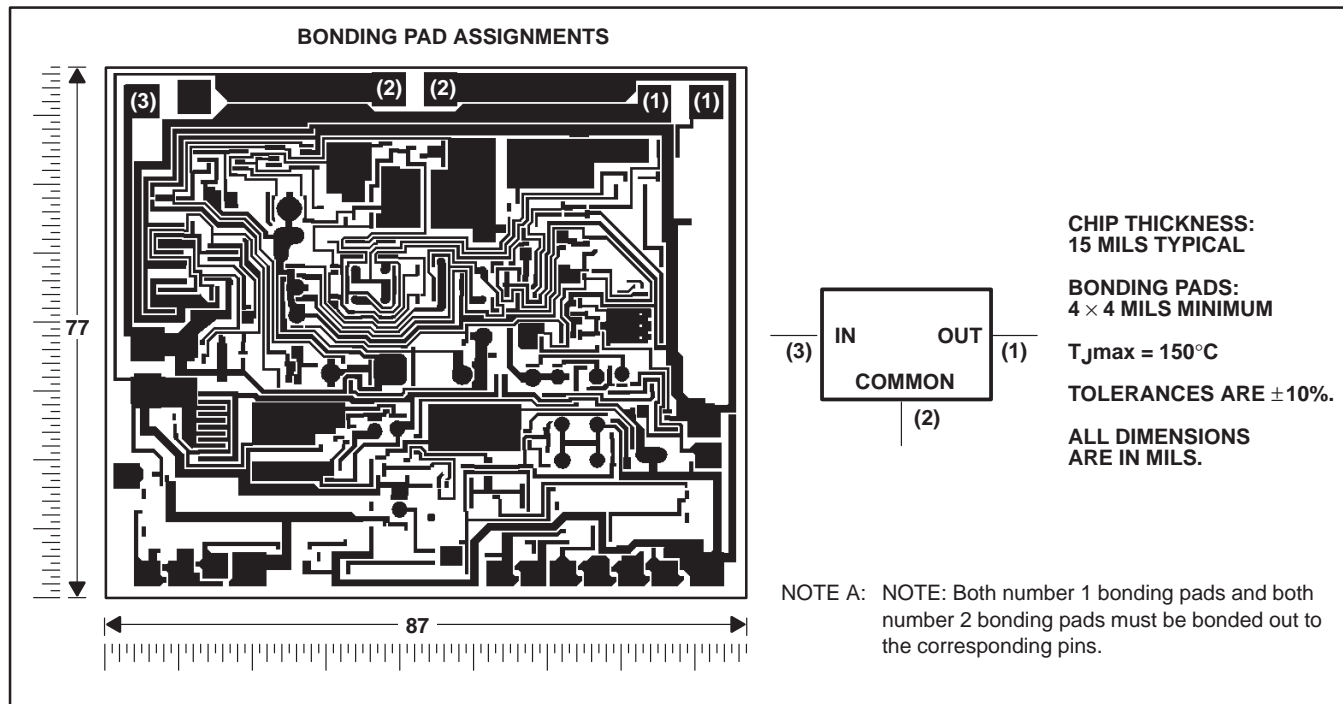

TLE2425, TLE2425Y PRECISION VIRTUAL GROUND

SLOS065C – MARCH 1991 – REVISED MAY 1998

absolute maximum ratings over operating free-air temperature range (unless otherwise noted)†

Continuous input voltage, V_I	40 V
Output current, I_O	± 80 mA
Duration of short-circuit current at (or below) 25°C (see Note 1)	unlimited
Continuous total power dissipation	See Dissipation Rating Table
Operating free-air temperature range, T_A : C-suffix	0°C to 70°C
I-suffix	-40°C to 85°C
M-suffix	-55°C to 125°C
Storage temperature range, T_{stg}	-65°C to 150°C
Lead temperature 1,6 mm (1/16 inch) from case for 10 seconds: D package	260°C
Lead temperature 1,6 mm (1/16 inch) from case for 60 seconds: JG or LP package	300°C

† Stresses beyond those listed under “absolute maximum ratings” may cause permanent damage to the device. These are stress ratings only, and functional operation of the device at these or any other conditions beyond those indicated under “recommended operating conditions” is not implied. Exposure to absolute-maximum-rated conditions for extended periods may affect device reliability.

NOTE 1: The output may be shorted to either supply. Temperature and/or supply voltages must be limited to ensure that the maximum dissipation rating is not exceeded.

DISSIPATION RATING TABLE

PACKAGE	$T_A \leq 25^\circ\text{C}$	DERATING FACTOR	$T_A = 70^\circ\text{C}$	$T_A = 85^\circ\text{C}$	$T_A = 125^\circ\text{C}$
	POWER RATING	ABOVE $T_A = 25^\circ\text{C}$	POWER RATING	POWER RATING	POWER RATING
D	725 mW	5.8 mW/°C	464 mW	377 mW	145 mW
JG	1050 mW	8.4 mW/°C	672 mW	546 mW	210 mW
LP	775 mW	6.2 mW/°C	496 mW	403 mW	155 mW

recommended operating conditions

	C-SUFFIX		I-SUFFIX		M-SUFFIX		UNIT
	MIN	MAX	MIN	MAX	MIN	MAX	
Input voltage, V_I	4	40	4	40	4	40	V
Operating free-air temperature, T_A	0	70	-40	85	-55	125	°C

TLE2425, TLE2425Y PRECISION VIRTUAL GROUND

SLOS065C – MARCH 1991 – REVISED MAY 1998

electrical characteristics at specified free-air temperature, $V_I = 5\text{ V}$, $I_O = 0$ (unless otherwise noted)

PARAMETER	TEST CONDITIONS	T_A †	TLE2425C			UNIT
			MIN	TYP	MAX	
Output voltage		25°C	2.48	2.5	2.52	V
		Full range	2.47		2.53	
Temperature coefficient of output voltage		25°C		20		ppm/°C
Bias current	$I_O = 0$	25°C		170	250	μA
		Full range			250	
Input voltage regulation	$V_I = 4.5\text{ V to }5.5\text{ V}$	25°C		1.5	20	μV
		Full range			25	
	$V_I = 4\text{ V to }40\text{ V}$	25°C		1.5	20	μV/V
		Full range			25	
Ripple rejection	$f = 120\text{ Hz}$, $\Delta V_I(\text{PP}) = 1\text{ V}$	25°C		80		dB
Output voltage regulation (source current) ‡	$I_O = 0\text{ to }-10\text{ mA}$	25°C	-160	-45	160	μV
		Full range	-250		250	
	$I_O = 0\text{ to }-20\text{ mA}$	25°C	-450	-150	450	
Output voltage regulation (sink current) ‡	$I_O = 0\text{ to }10\text{ mA}$	25°C	-160	15	160	μV
		Full range	-250		250	
	$I_O = 0\text{ to }20\text{ mA}$	25°C	-235	65	235	
Long-term drift of output voltage	$\Delta t = 1000\text{ h}$, Noncumulative	25°C		15		ppm
Output impedance		25°C		7.5	22.5	mΩ
Short-circuit output current (sink current)	$V_O = 5\text{ V}$	25°C	30	55		mA
Short-circuit output current (source current)	$V_O = 0$		-30	-50		
Output noise voltage, rms	$f = 10\text{ Hz to }10\text{ kHz}$	25°C		100		μV
Output voltage response to output current step	$V_O\text{ to }0.1\%$, $I_O = \pm 10\text{ mA}$	$C_L = 0$	25°C		110	μs
				$C_L = 100\text{ pF}$	115	
	$V_O\text{ to }0.01\%$, $I_O = \pm 10\text{ mA}$	$C_L = 0$		180		
		$C_L = 100\text{ pF}$		180		
Output voltage response to input voltage step	$V_I = 4.5\text{ to }5.5\text{ V}$, $V_O\text{ to }0.1\%$	25°C		12	μs	
	$V_I = 4.5\text{ to }5.5\text{ V}$, $V_O\text{ to }0.01\%$			30		
Output voltage turn-on response	$V_I = 0\text{ to }5\text{ V}$, $V_O\text{ to }0.1\%$	25°C		125	μs	
	$V_I = 0\text{ to }5\text{ V}$, $V_O\text{ to }0.01\%$			210		

† Full range is 0°C to 70°C.

‡ The listed values are not production tested.

TLE2425, TLE2425Y PRECISION VIRTUAL GROUND

SLOS065C – MARCH 1991 – REVISED MAY 1998

electrical characteristics at specified free-air temperature, $V_I = 5\text{ V}$, $I_O = 0$ (unless otherwise noted)

PARAMETER	TEST CONDITIONS	T_A †	TLE2425I			UNIT
			MIN	TYP	MAX	
Output voltage		25°C	2.48	2.5	2.52	V
		Full range	2.47		2.53	
Temperature coefficient of output voltage		25°C		20		ppm/°C
Bias current	$I_O = 0$	25°C		170	250	μA
		Full range			250	
Input voltage regulation	$V_I = 4.5\text{ V to }5.5\text{ V}$	25°C		1.5	20	μV
		Full range			75	
	$V_I = 4\text{ V to }40\text{ V}$	25°C		1.5	20	μV/V
		Full range			75	
Ripple rejection	$f = 120\text{ Hz}$, $\Delta V_I(\text{PP}) = 1\text{ V}$	25°C		80		dB
Output voltage regulation (source current)‡	$I_O = 0\text{ to }-10\text{ mA}$	25°C	-160	-45	160	μV
		Full range	-250		250	
	$I_O = 0\text{ to }-20\text{ mA}$	25°C	-450	-150	450	
Output voltage regulation (sink current)‡	$I_O = 0\text{ to }8\text{ mA}$	25°C	-160	15	160	μV
		Full range	-250		250	
	$I_O = 0\text{ to }20\text{ mA}$	25°C	-235	65	235	
Long-term drift of output voltage	$\Delta t = 1000\text{ h}$, Noncumulative	25°C		15		ppm
Output impedance		25°C		7.5	22.5	mΩ
Short-circuit output current (sink current)	$V_O = 5\text{ V}$	25°C	30	55		mA
Short-circuit output current (source current)	$V_O = 0$		-30	-50		
Output noise voltage, rms	$f = 10\text{ Hz to }10\text{ kHz}$	25°C		100		μV
Output voltage response to output current step	V_O to 0.1%, $I_O = \pm 10\text{ mA}$	25°C		$C_L = 0$	110	μs
				$C_L = 100\text{ pF}$	115	
	V_O to 0.01%, $I_O = \pm 10\text{ mA}$			$C_L = 0$	180	
				$C_L = 100\text{ pF}$	180	
Output voltage response to input voltage step	$V_I = 4.5\text{ to }5.5\text{ V}$, V_O to 0.1%	25°C			12	μs
	$V_I = 4.5\text{ to }5.5\text{ V}$, V_O to 0.01%				30	
Output voltage turn-on response	$V_I = 0\text{ to }5\text{ V}$, V_O to 0.1%	25°C			125	μs
	$V_I = 0\text{ to }5\text{ V}$, V_O to 0.01%				210	

† Full range is -40°C to 85°C.

‡ The listed values are not production tested.

TLE2425, TLE2425Y PRECISION VIRTUAL GROUND

SLOS065C – MARCH 1991 – REVISED MAY 1998

electrical characteristics at specified free-air temperature, $V_I = 5\text{ V}$, $I_O = 0$ (unless otherwise noted)

PARAMETER	TEST CONDITIONS	T_A †	TLE2425M			UNIT
			MIN	TYP	MAX	
Output voltage		25°C	2.48	2.5	2.52	V
		Full range	2.47		2.53	
Temperature coefficient of output voltage		25°C		20		ppm/°C
Bias current	$I_O = 0$	25°C		170	250	μA
		Full range			250	
Input voltage regulation	$V_I = 4.5\text{ V to }5.5\text{ V}$	25°C		1.5	20	μV
		Full range			100	
	$V_I = 4.5\text{ V to }40\text{ V}$	25°C		1.5	20	μV/V
		Full range			100	
Ripple rejection	$f = 120\text{ Hz}$, $\Delta V_I(\text{PP}) = 1\text{ V}$	25°C		80		dB
Output voltage regulation (source current) ‡	$I_O = 0\text{ to }-10\text{ mA}$	25°C	-160	-45	160	μV
		Full range	-250		250	
	$I_O = 0\text{ to }-20\text{ mA}$	25°C	-450	-150	450	
Output voltage regulation (sink current) ‡	$I_O = 0\text{ to }3\text{ mA}$	25°C	-160	15	160	μV
		Full range	-250		250	
	$I_O = 0\text{ to }20\text{ mA}$	25°C	-235	65	235	
Long-term drift of output voltage	$\Delta t = 1000\text{ h}$, Noncumulative	25°C		15		ppm
Output impedance		25°C		7.5	22.5	mΩ
Short-circuit output current (sink current)	$V_O = 5\text{ V}$	25°C	30	55		mA
Short-circuit output current (source current)	$V_O = 0$		-30	-50		
Output noise voltage, rms	$f = 10\text{ Hz to }10\text{ kHz}$	25°C		100		μV
Output voltage response to output current step	$V_O\text{ to }0.1\%$, $I_O = \pm 10\text{ mA}$	25°C	$C_L = 0$		110	μs
			$C_L = 100\text{ pF}$		115	
	$V_O\text{ to }0.01\%$, $I_O = \pm 10\text{ mA}$	$C_L = 0$		180		
		$C_L = 100\text{ pF}$		180		
Output voltage response to input voltage step	$V_I = 4.5\text{ to }5.5\text{ V}$, $V_O\text{ to }0.1\%$	25°C		12	μs	
	$V_I = 4.5\text{ to }5.5\text{ V}$, $V_O\text{ to }0.01\%$			30		
Output voltage turn-on response	$V_I = 0\text{ to }5\text{ V}$, $V_O\text{ to }0.1\%$	25°C		125	μs	
	$V_I = 0\text{ to }5\text{ V}$, $V_O\text{ to }0.01\%$			210		

† Full range is -55°C to 125°C.

‡ The listed values are not production tested.

TLE2425, TLE2425Y PRECISION VIRTUAL GROUND

SLOS065C – MARCH 1991 – REVISED MAY 1998

electrical characteristics $V_I = 5\text{ V}$, $I_O = 0$, $T_A = 25^\circ\text{C}$ (unless otherwise noted)

PARAMETER	TEST CONDITIONS	TLE2425Y			UNIT
		MIN	TYP	MAX	
Output voltage			2.5		V
Temperature coefficient of output voltage			20		ppm/°C
Bias current	$I_O = 0$		170		μA
Input voltage regulation	$V_I = 4.5\text{ V to } 5.5\text{ V}$		1.5		μV
	$V_I = 4\text{ V to } 40\text{ V}$		1.5		$\mu\text{V/V}$
Ripple rejection	$f = 120\text{ Hz}$, $\Delta V_I(\text{PP}) = 1\text{ V}$		80		dB
Output voltage regulation (source current)†	$I_O = 0\text{ to } -10\text{ mA}$		-45		μV
	$I_O = 0\text{ to } -20\text{ mA}$		-150		
Output voltage regulation (sink current)†	$I_O = 0\text{ to } 10\text{ mA}$		15		μV
	$I_O = 0\text{ to } 20\text{ mA}$		65		
Output impedance			7.5		$\text{m}\Omega$
Short-circuit output current (sink current)	$V_O = 5\text{ V}$		55		mA
Short-circuit output current (source current)	$V_O = 0$		-50		
Output noise voltage, rms	$f = 10\text{ Hz to } 10\text{ kHz}$		100		μV
Output voltage response to output current step	$V_O\text{ to } 0.1\%$, $I_O = \pm 10\text{ mA}$	$C_L = 0$	110		μs
		$C_L = 100\text{ pF}$	115		
	$V_O\text{ to } 0.01\%$, $I_O = \pm 10\text{ mA}$	$C_L = 0$	180		
		$C_L = 100\text{ pF}$	180		
Output voltage response to input voltage step	$V_I = 4.5\text{ to } 5.5\text{ V}$, $V_O\text{ to } 0.1\%$		12		μs
	$V_I = 4.5\text{ to } 5.5\text{ V}$, $V_O\text{ to } 0.01\%$		30		
Output voltage turn-on response	$V_I = 0\text{ to } 5\text{ V}$, $V_O\text{ to } 0.1\%$		125		μs
	$V_I = 0\text{ to } 5\text{ V}$, $V_O\text{ to } 0.01\%$		210		

† The listed values are not production tested.

TLE2425, TLE2425Y PRECISION VIRTUAL GROUND

SLOS065C – MARCH 1991 – REVISED MAY 1998

TYPICAL CHARACTERISTICS

Table Of Graphs

		FIGURE
Output voltage	Distribution	1
	vs Free-air temperature	2
Output voltage hysteresis	vs Free-air temperature	3
Input bias current	vs Input voltage	4
	vs Free-air temperature	5
Input voltage regulation		6
Ripple rejection	vs Frequency	7
Output voltage regulation		8
Output impedance	vs Frequency	9
Short-circuit output current	vs Free-air temperature	10
Spectral noise voltage density	vs Frequency	11
Wide-band noise voltage	vs Frequency	12
Output voltage change with current step	vs Time	13
Output voltage change with voltage step	vs Time	14
Output voltage power-up response	vs Time	15
Output current	vs Load capacitance	16

TYPICAL CHARACTERISTICS†

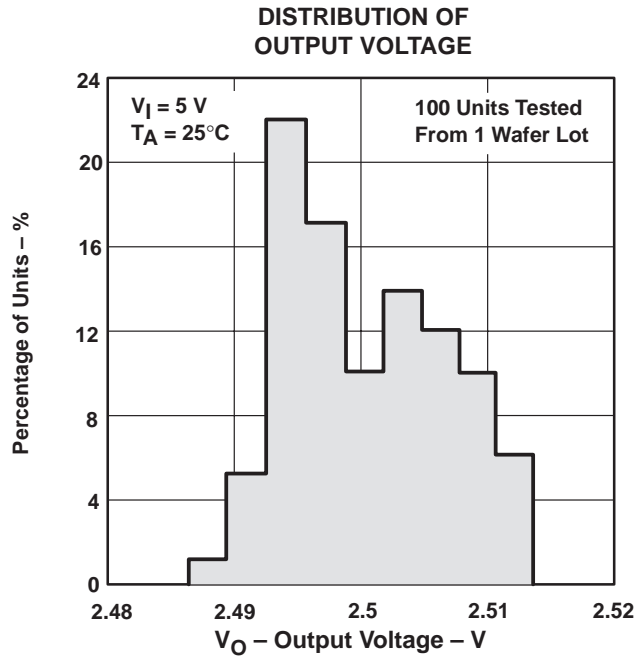

Figure 1

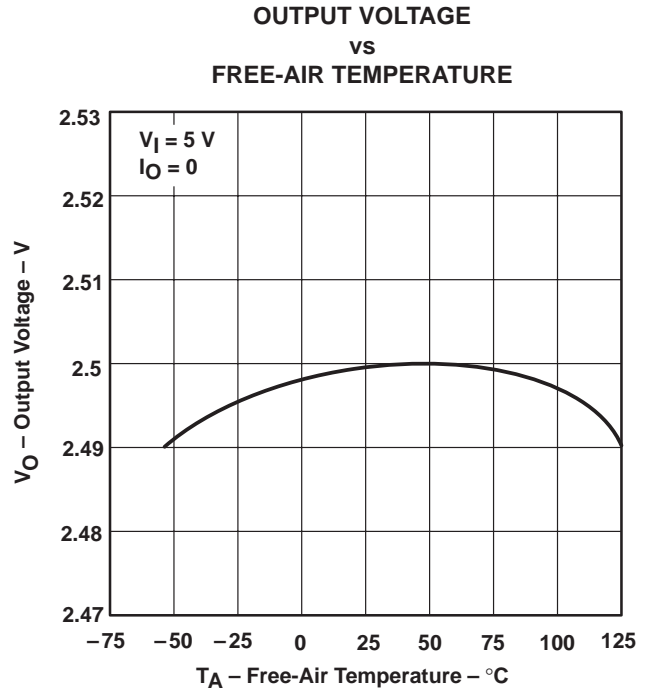

Figure 2

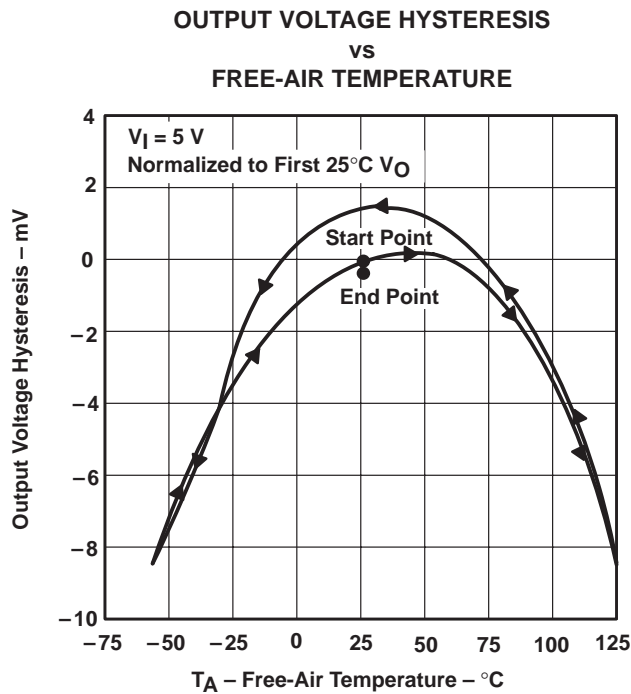

Figure 3

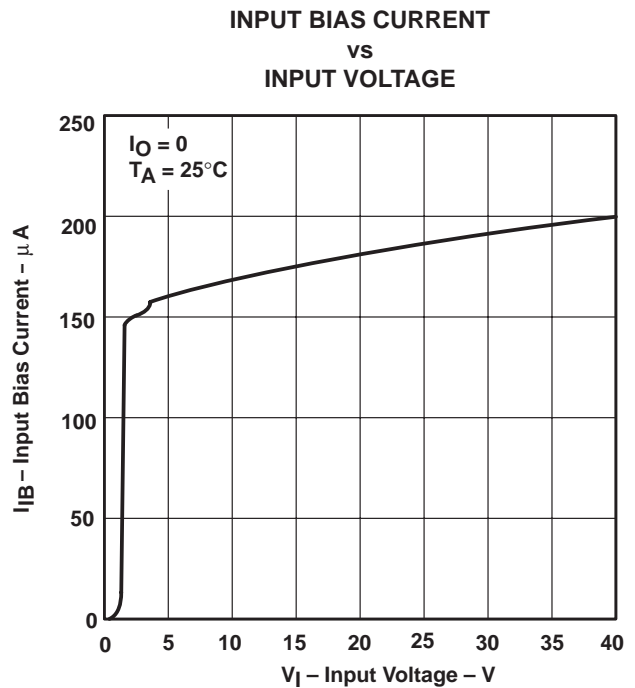

Figure 4

† Data at high and low temperatures are applicable within rated operating free-air temperature ranges of the various devices.

TLE2425, TLE2425Y PRECISION VIRTUAL GROUND

SLOS065C – MARCH 1991 – REVISED MAY 1998

TYPICAL CHARACTERISTICS†

**INPUT BIAS CURRENT
VS
FREE-AIR TEMPERATURE**

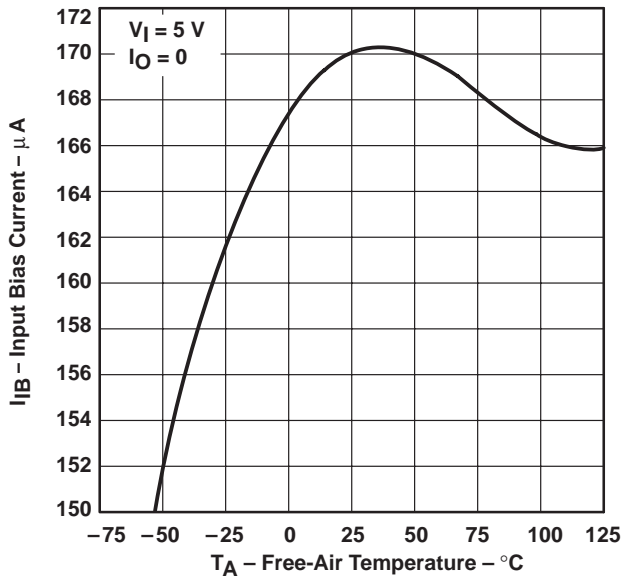

Figure 5

INPUT VOLTAGE REGULATION

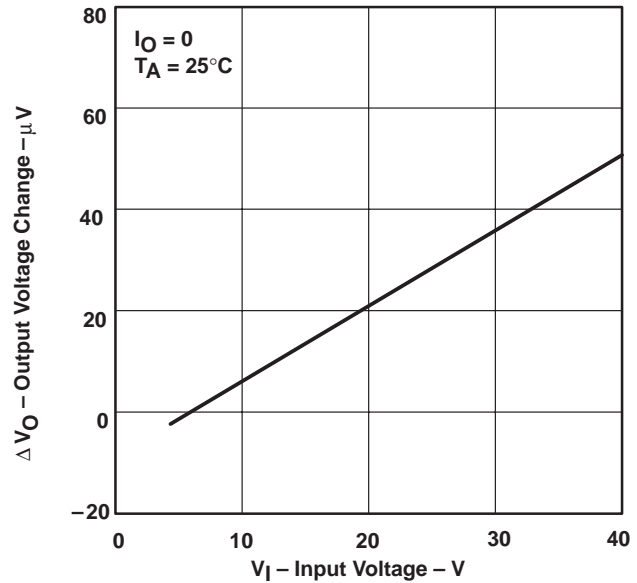

Figure 6

**RIPPLE REJECTION
VS
FREQUENCY**

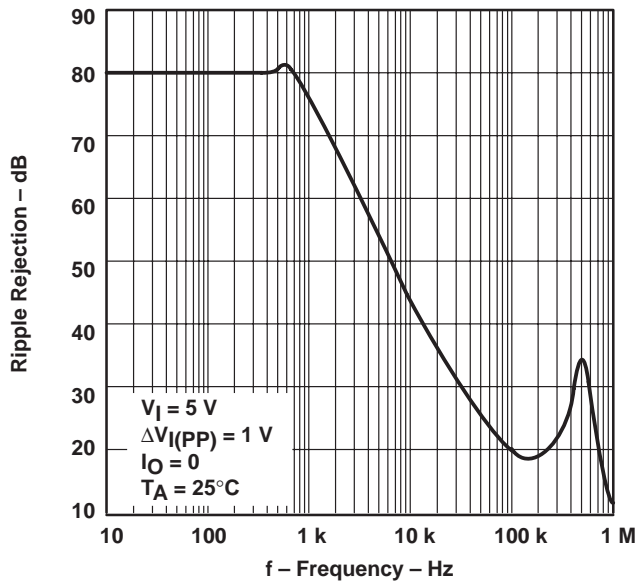

Figure 7

OUTPUT VOLTAGE REGULATION

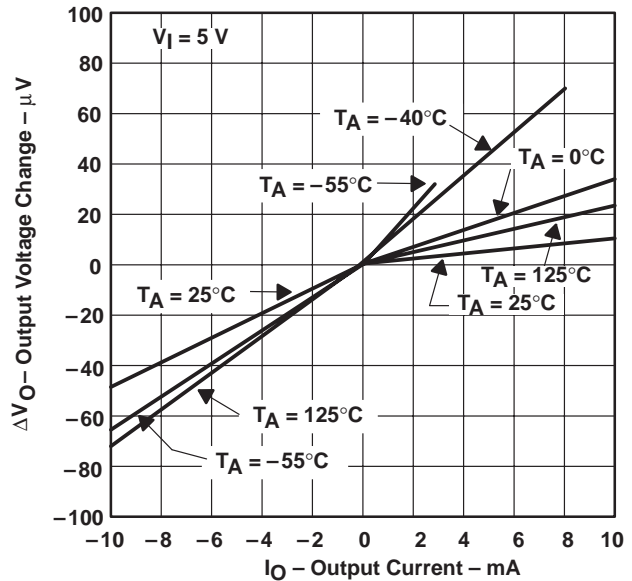

Figure 8

† Data at high and low temperatures are applicable within rated operating free-air temperature ranges of the various devices.

TYPICAL CHARACTERISTICS

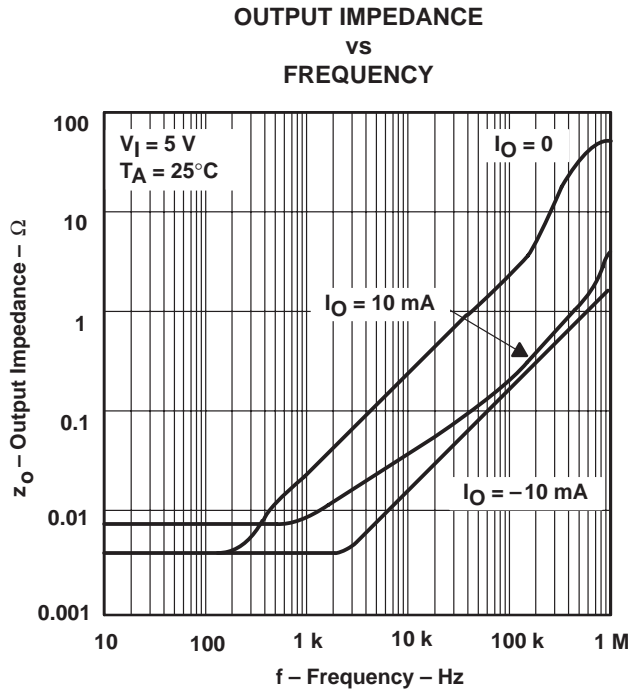

Figure 9

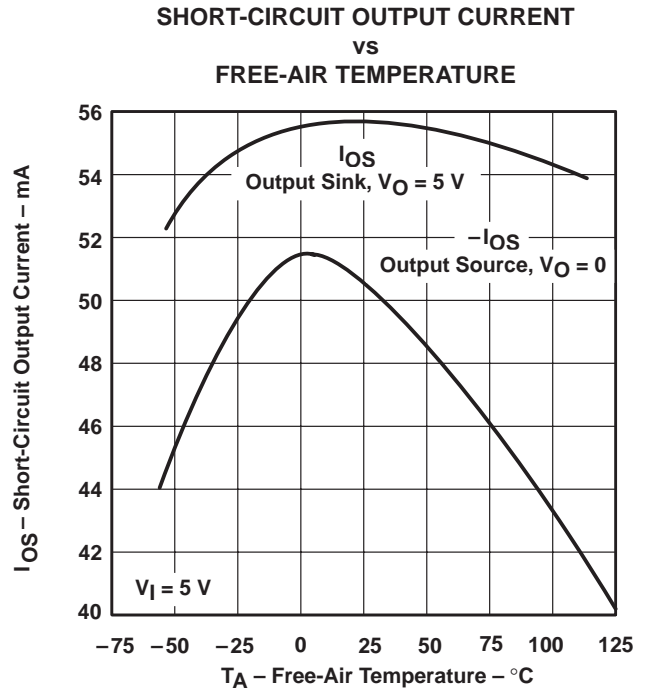

Figure 10

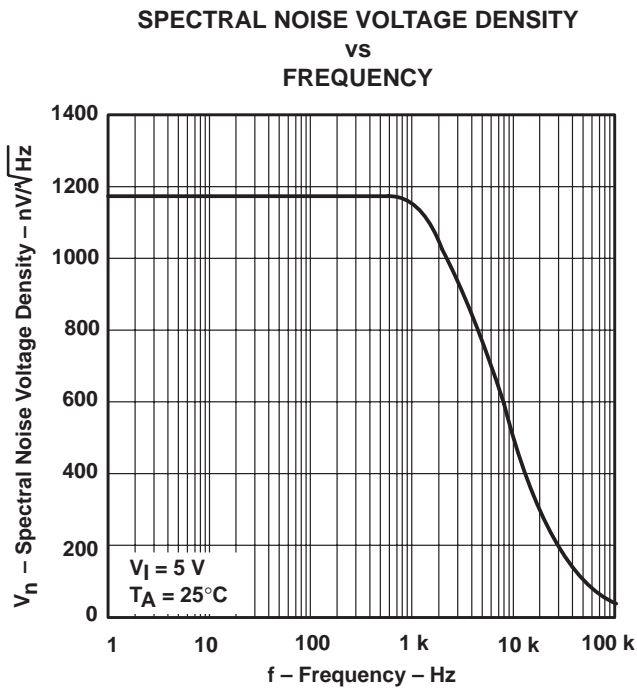

Figure 11

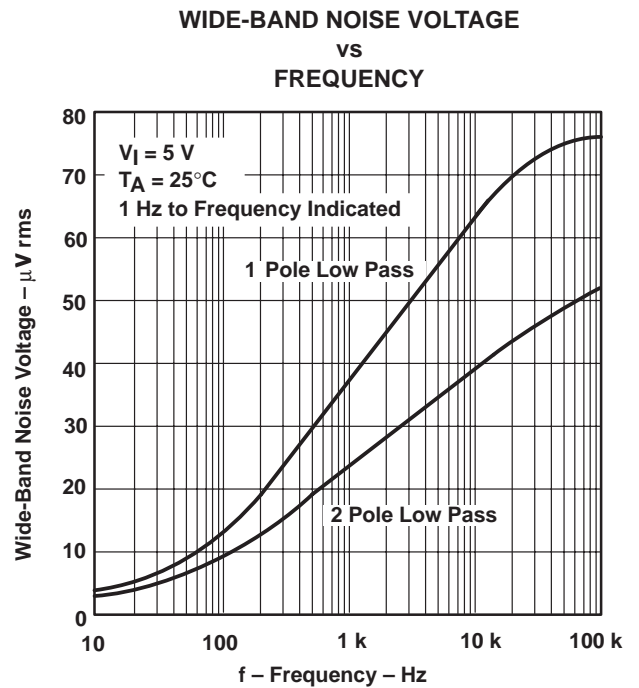

Figure 12

TLE2425, TLE2425Y PRECISION VIRTUAL GROUND

SLOS065C – MARCH 1991 – REVISED MAY 1998

TYPICAL CHARACTERISTICS

OUTPUT VOLTAGE RESPONSE
TO OUTPUT CURRENT STEP
VS
TIME

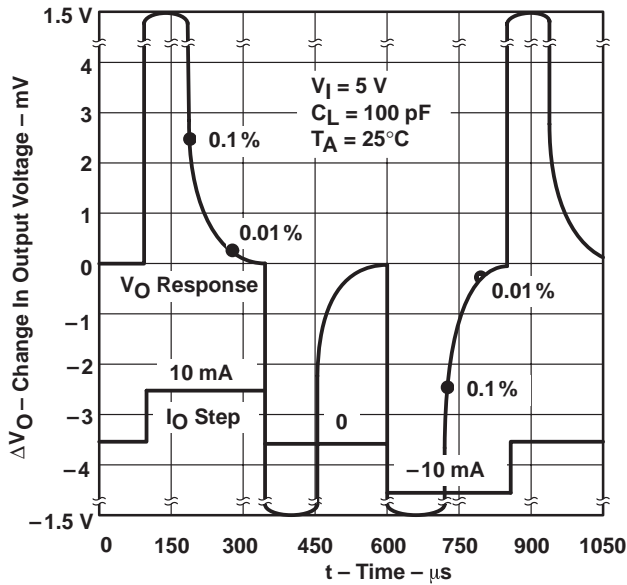

Figure 13

OUTPUT VOLTAGE RESPONSE
TO INPUT VOLTAGE STEP
VS
TIME

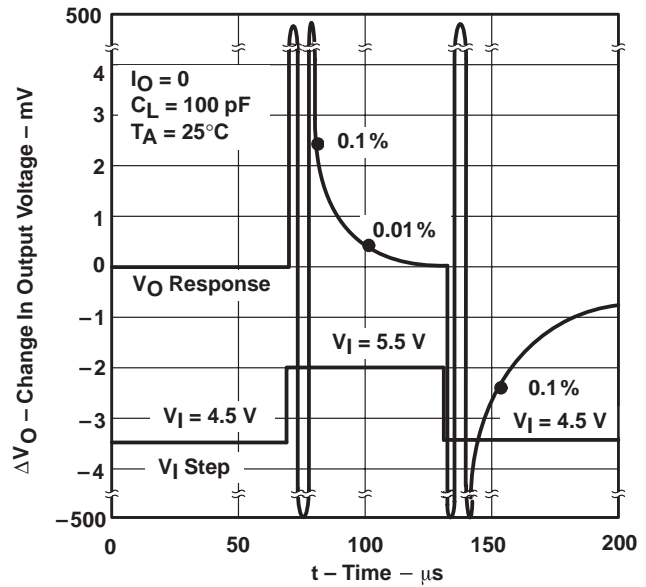

Figure 14

OUTPUT VOLTAGE POWER-UP RESPONSE
VS
TIME

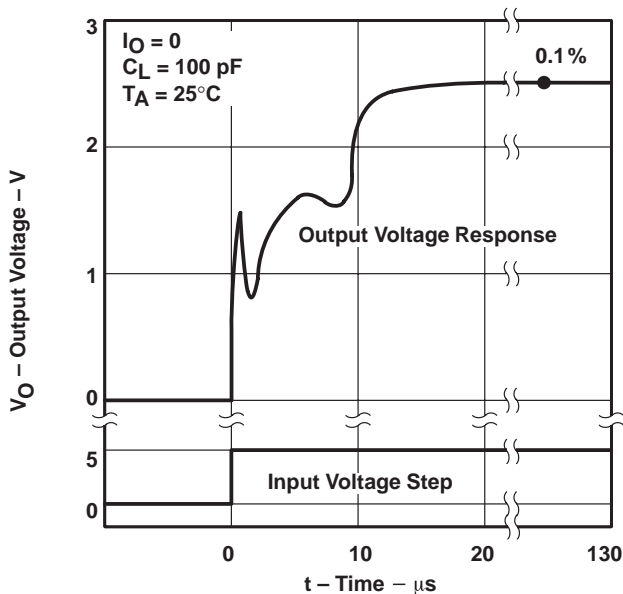

Figure 15

STABILITY RANGE
OUTPUT CURRENT
VS
LOAD CAPACITANCE

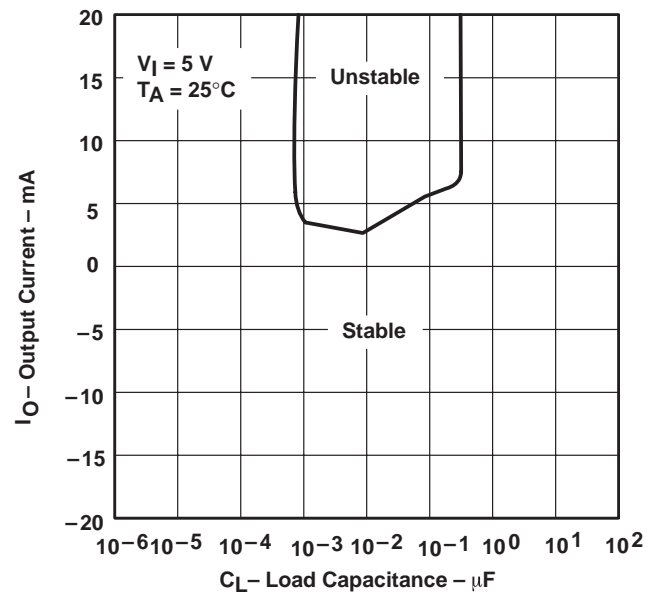

Figure 16

TLE2425, TLE2425Y PRECISION VIRTUAL GROUND

SLOS065C – MARCH 1991 – REVISED MAY 1998

macromodel information

```
* TLE2425 OPERATIONAL AMPLIFIER "MACROMODEL" SUBCIRCUIT
* CREATED USING PARTS RELEASE 4.03 ON 08/21/90 AT 13:51
* REV (N/A) SUPPLY VOLTAGE: 5 V
* CONNECTIONS: INPUT
*                |   COMMON
*                |   |   OUTPUT
*                |   |   |
*                |   |   |
* .SUBCKT TLE2425 3   4   5
*
```

```
* OPAMP SECTION
C1  11 12 21.66E-12
C2  6  7 30.00E-12
C3  87 0 10.64E-9
CPSR 85 86 15.9E-9
DCM+ 81 82 DX
DCM- 83 81 DX
DC  5 53 DX
DE  54 5  DX
DLN 92 90 DX
DLP 90 91 DX
DP  4 3  DX
ECMR 84 99 (2,99) 1
EGND 99 0 POLY(2) (3,0) (4,0) 0 .5 .5
EPSR 85 0 POLY(1) (3,4) -16.22E-6 3.24E-6
ENSE 89 2 POLY(1) (88,0) 120E-6 1
FB  7 99 POLY(6) VB VC VE VLP VLN VPSR 0 74.8E6 -10E6 10E6 10E6
+ -10E6 74E6
GA  6 0 11 12 320.4E-6
GCM  0 6 10 99 1.013E-9
GPSR 85 86 (85,86) 100E-6
GRC1 4 11 (4,11) 3.204E-4
GRC2 4 12 (4,12) 3.204E-4
GRE1 13 10 (13,10) 1.038E-3
GRE2 14 10 (14,10) 1.038E-3
HLIM 90 0 VLIM 1K
HCMR 80 1 POLY(2) VCM+ VCM- 0 1E2 1E2
IRP  3 4 146E-6
IEE  3 10 DC 24.05E-6
IIO  2 0 .2E-9
I1  88 0 1E-21
Q1  11 89 13 QX
Q2  12 80 14 QX
R2  6 9 100.0E3
RCM 84 81 1K
REE 10 99 8.316E6
RN1 87 0 2.55E8
RN2 87 88 11.67E3
```

TLE2425, TLE2425Y PRECISION VIRTUAL GROUND

SLOS065C – MARCH 1991 – REVISED MAY 1998

macromodel information (continued)

```
RO1      8  5  63
RO2      7 99  62
VCM+    82 99  1.0
VCM-    83 99 -2.3
VB       9  0  DC 0
VC       3 53  DC 1.400
VE      54  4  DC 1.400
VLIM     7  8  DC  0
VLP     91  0  DC 30
VLN     0 92  DC 30
VPSR    0 86  DC  0
RFB     5  2  1K
RIN    30  1  1K
RCOM    34  4  .1
*REGULATOR SECTION
RG1     30  0  20MEG
RG2     30 31  .2
RG3     31 35  400K
RG4     35 34  411K
RG5     31 36  25MEG
HREG    31 32  POLY(2)   VPSET  VNSET  0  1E2 1E2
VREG    32 33  DC 0V
EREG    33 34  POLY(1)   (36,34)  1.23 1
VADJ    36 34  1.27V
HPSET   37  0  VREG  1.030E3
VPSET   38  0  DC 20V
HNSET   39  0  VREG  6.11E5
VNSET   40  0  DC -20V
DSUB    4  34  DX
DPOS    37 38  DX
DNNEG   40 39  DX
.MODEL  DX  D(IS=800.0E-18)
.MODEL  QX  PNP(IS=800.0E-18 BF=480)
.ENDS
```

TLE2425, TLE2425Y PRECISION VIRTUAL GROUND

SLOS065C – MARCH 1991 – REVISED MAY 1998

MECHANICAL INFORMATION

D (R-PDSO-G**)

PLASTIC SMALL-OUTLINE PACKAGE

14 PIN SHOWN

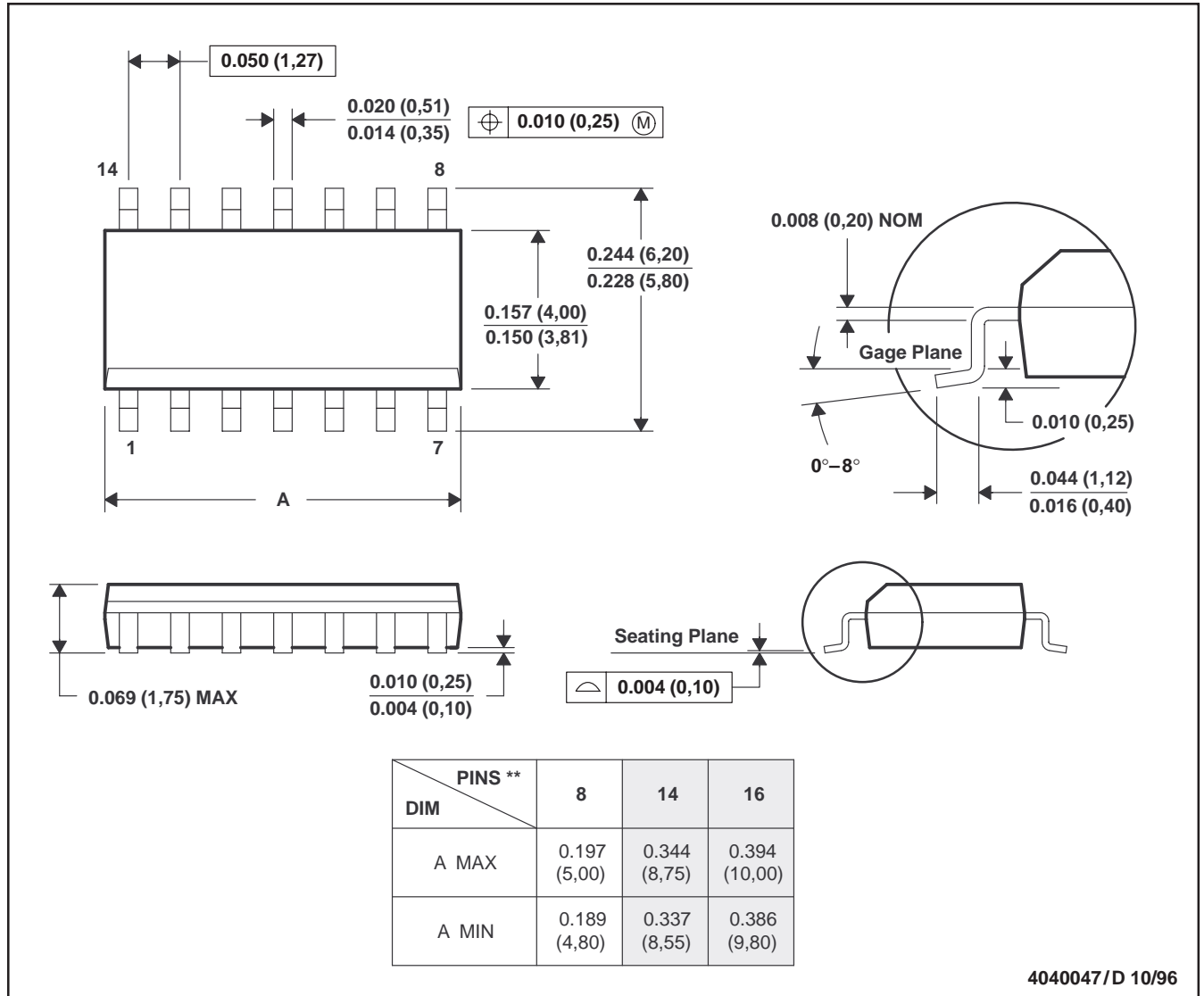

- NOTES: A. All linear dimensions are in inches (millimeters).
 B. This drawing is subject to change without notice.
 C. Body dimensions do not include mold flash or protrusion, not to exceed 0.006 (0,15).
 D. Falls within JEDEC MS-012

TLE2425, TLE2425Y PRECISION VIRTUAL GROUND

SLOS065C – MARCH 1991 – REVISED MAY 1998

MECHANICAL INFORMATION

JG (R-GDIP-T8)

CERAMIC DUAL-IN-LINE PACKAGE

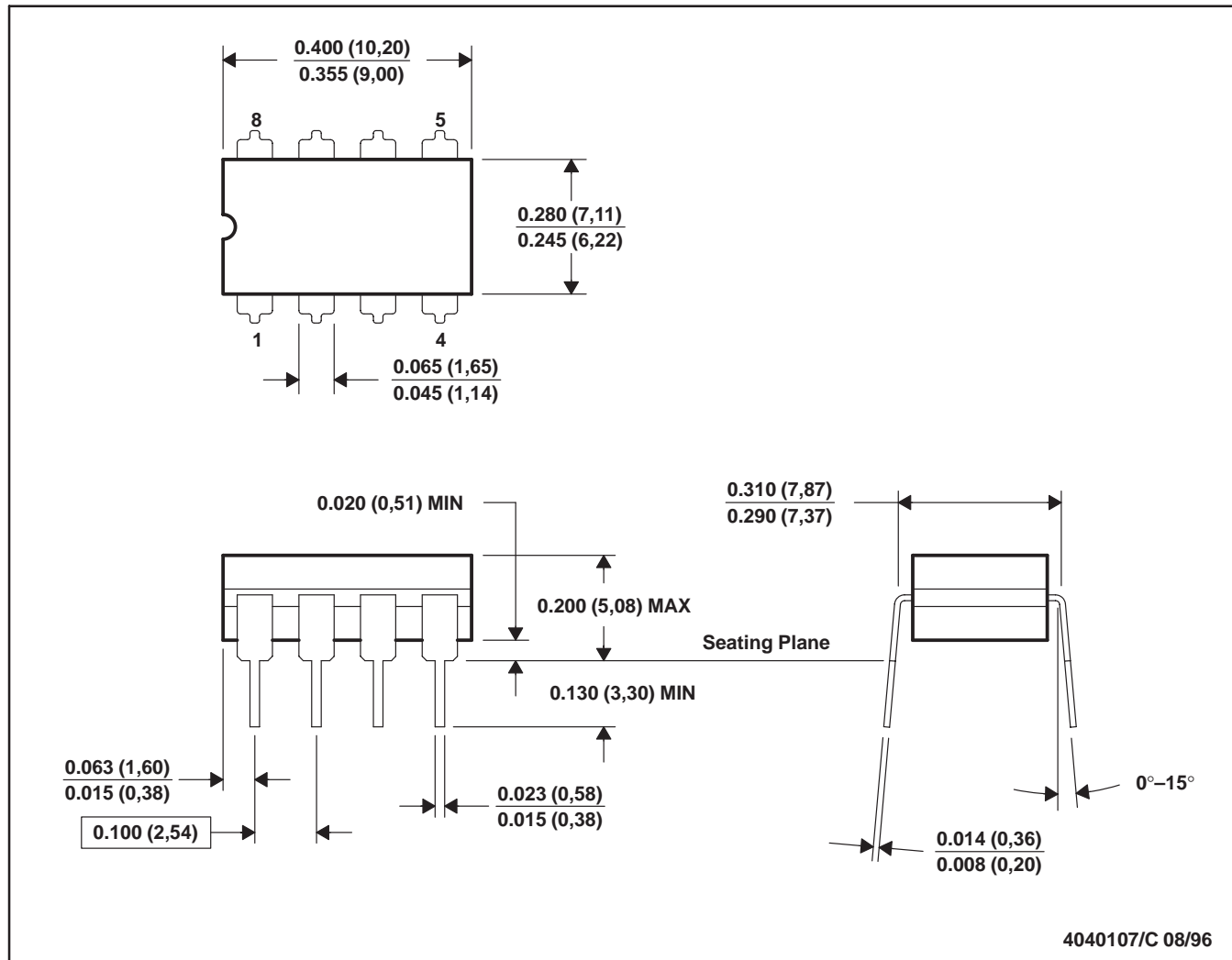

- NOTES:
- All linear dimensions are in inches (millimeters).
 - This drawing is subject to change without notice.
 - This package can be hermetically sealed with a ceramic lid using glass frit.
 - Index point is provided on cap for terminal identification only on press ceramic glass frit seal only.
 - Falls within MIL-STD-1835 GDIP1-T8

TLE2425, TLE2425Y PRECISION VIRTUAL GROUND

SLOS065C – MARCH 1991 – REVISED MAY 1998

MECHANICAL INFORMATION

LP (O-PBCY-W3)

PLASTIC CYLINDRICAL PACKAGE

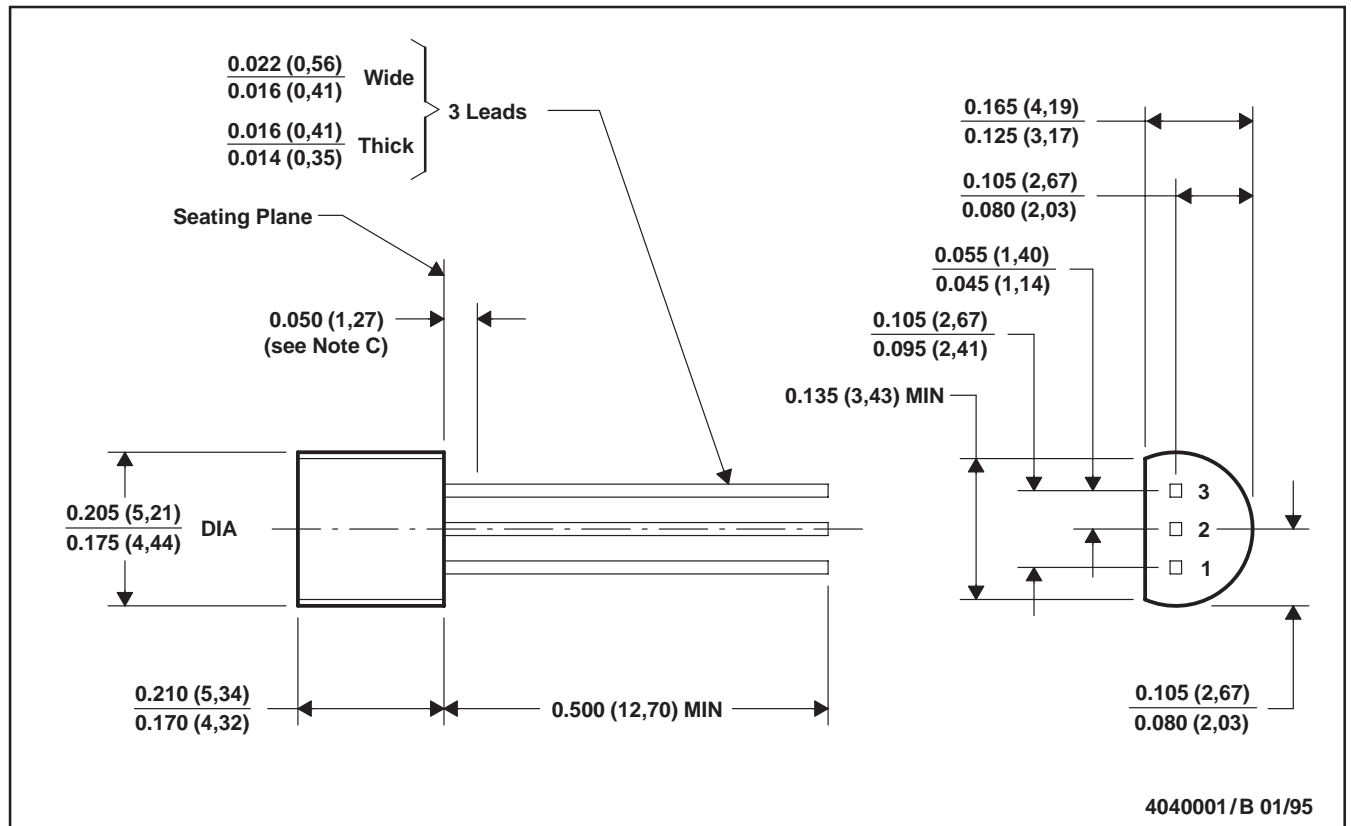

- NOTES: A. All linear dimensions are in inches (millimeters).
 B. This drawing is subject to change without notice.
 C. Lead dimensions are not controlled within this area.
 D. Falls within JEDEC TO-226AA (TO-226AA replaces TO-92)

IMPORTANT NOTICE

Texas Instruments and its subsidiaries (TI) reserve the right to make changes to their products or to discontinue any product or service without notice, and advise customers to obtain the latest version of relevant information to verify, before placing orders, that information being relied on is current and complete. All products are sold subject to the terms and conditions of sale supplied at the time of order acknowledgement, including those pertaining to warranty, patent infringement, and limitation of liability.

TI warrants performance of its semiconductor products to the specifications applicable at the time of sale in accordance with TI's standard warranty. Testing and other quality control techniques are utilized to the extent TI deems necessary to support this warranty. Specific testing of all parameters of each device is not necessarily performed, except those mandated by government requirements.

CERTAIN APPLICATIONS USING SEMICONDUCTOR PRODUCTS MAY INVOLVE POTENTIAL RISKS OF DEATH, PERSONAL INJURY, OR SEVERE PROPERTY OR ENVIRONMENTAL DAMAGE ("CRITICAL APPLICATIONS"). TI SEMICONDUCTOR PRODUCTS ARE NOT DESIGNED, AUTHORIZED, OR WARRANTED TO BE SUITABLE FOR USE IN LIFE-SUPPORT DEVICES OR SYSTEMS OR OTHER CRITICAL APPLICATIONS. INCLUSION OF TI PRODUCTS IN SUCH APPLICATIONS IS UNDERSTOOD TO BE FULLY AT THE CUSTOMER'S RISK.

In order to minimize risks associated with the customer's applications, adequate design and operating safeguards must be provided by the customer to minimize inherent or procedural hazards.

TI assumes no liability for applications assistance or customer product design. TI does not warrant or represent that any license, either express or implied, is granted under any patent right, copyright, mask work right, or other intellectual property right of TI covering or relating to any combination, machine, or process in which such semiconductor products or services might be or are used. TI's publication of information regarding any third party's products or services does not constitute TI's approval, warranty or endorsement thereof.