

DESCRIPTION

2SC3018 is a silicon NPN epitaxial planar type transistor designed for 7.2Volts VHF power amplifiers applications.

FEATURES

- High gain: $G_{pe} \geq 13dB$ @ $f = 175MHz$, $V_{CC} = 7.2V$
 $P_{in} = 0.15W$.
- Convenient ceramic type package with flange for high gain and excellent heat dissipation.
- Emitter ballasted construction.
- High ruggedness: Ability to withstand more than 20:1 load VSWR when operated at $V_{CC} = 9V$, $P_O = 3W$.

APPLICATION

Output stage of 2W portable type transmitter in VHF band.

OUTLINE DRAWING

Dimensions in mm

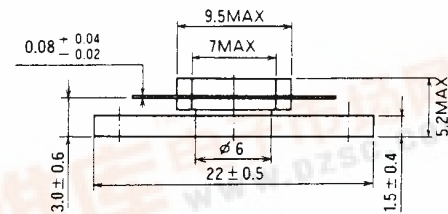
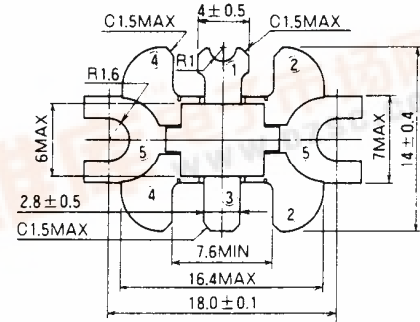

PIN :

- ① COLLECTOR
- ② EMITTER (FLANGE)
- ③ BASE
- ④ EMITTER (FLANGE)
- ⑤ FIN (EMITTER)

T-31E

ABSOLUTE MAXIMUM RATINGS ($T_C = 25^\circ C$)

Symbol	Parameter	Conditions	Ratings	Unit
V_{CBO}	Collector to base voltage		20	V
V_{EBO}	Emitter to base voltage		3.5	V
V_{CEO}	Collector to emitter voltage	$R_{BE} = \infty$	9	V
I_C	Collector current		1.5	A
P_C	Collector dissipation	$T_C = 25^\circ C$	10	W
T_j	Junction temperature		175	$^\circ C$
T_{stg}	Storage temperature		-55 to 175	$^\circ C$

Note. Above parameters are guaranteed independently.

ELECTRICAL CHARACTERISTICS ($T_C = 25^\circ C$)

Symbol	Parameter	Test conditions	Limits			Unit
			Min	Typ	Max	
$V_{(BR)EBO}$	Emitter to base breakdown voltage	$I_E = 1mA, I_C = 0$	3.5			V
$V_{(BR)CBO}$	Collector to base breakdown voltage	$I_C = 10mA, I_E = 0$	20			V
$V_{(BR)CEO}$	Collector to emitter breakdown voltage	$I_C = 10mA, R_{BE} = \infty$	9			V
I_{CBO}	Collector cut off current	$V_{CB} = 10V, I_E = 0$			300	μA
I_{EBO}	Emitter cut off current	$V_{EB} = 2V, I_C = 0$			300	μA
h_{FE}	DC forward current gain*	$V_{CE} = 5V, I_C = 0.1A$	20	50	180	—
P_O	Power Output	$V_{CC} = 7.2V, P_{in} = 0.15W, f = 175MHz$	3.0	3.5		W
η_C	Collector efficiency		55	60		%

Note: * Pulse test, $P_W = 150\mu s$, duty = 5%.
Above parameters, ratings, limits and conditions are subject to change.

MITSUBISHI RF POWER TRANSISTOR 2SC3018

NPN EPITAXIAL PLANAR TYPE

TEST CIRCUIT

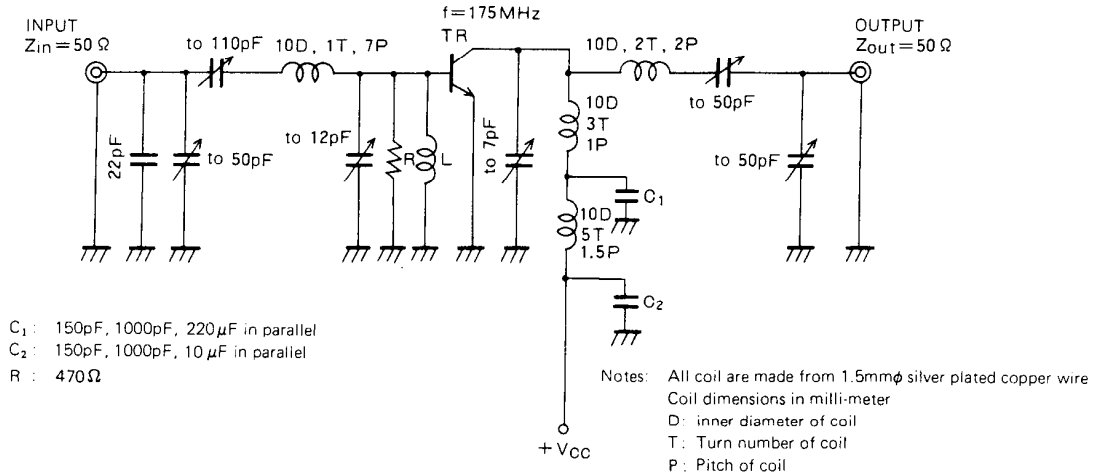

TYPICAL PERFORMANCE DATA

COLLECTOR DISSIPATION VS. CASE TEMPERATURE CHARACTERISTICS

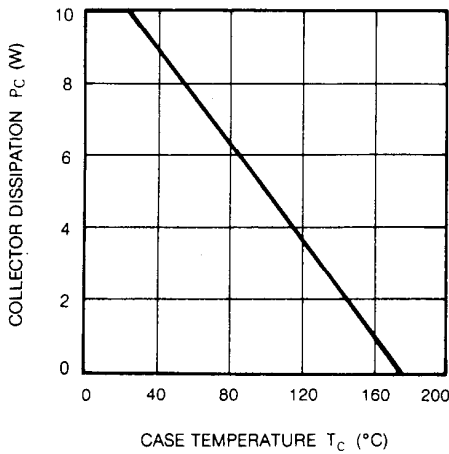

DC CURRENT GAIN VS. COLLECTOR CURRENT

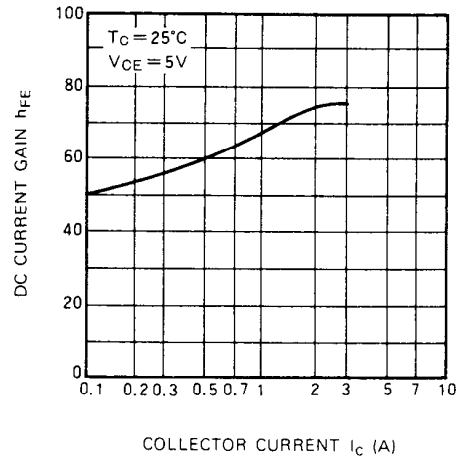

COLLECTOR OUTPUT CAPACITANCE VS. COLLECTOR TO BASE VOLTAGE

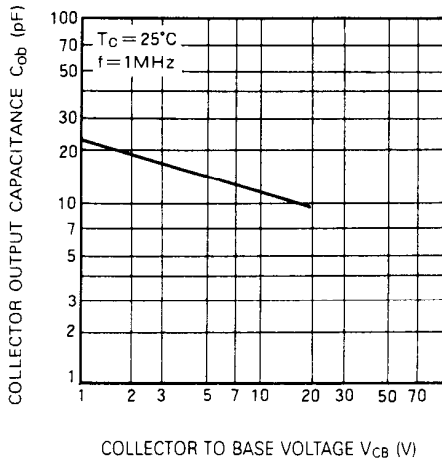

OUTPUT POWER, COLLECTOR EFFICIENCY VS. INPUT POWER CHARACTERISTICS

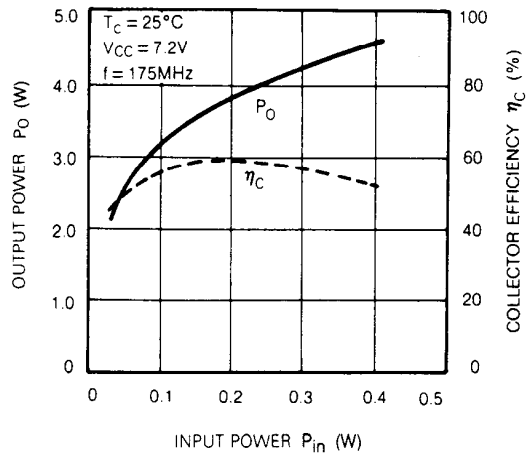

OUTPUT POWER VS. COLLECTOR SUPPLY VOLTAGE CHARACTERISTICS

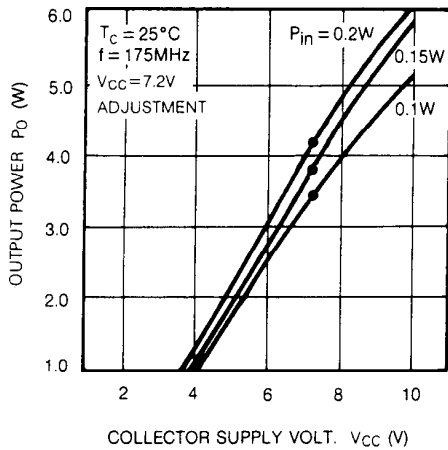

OUTPUT POWER VS. FREQUENCY CHARACTERISTICS

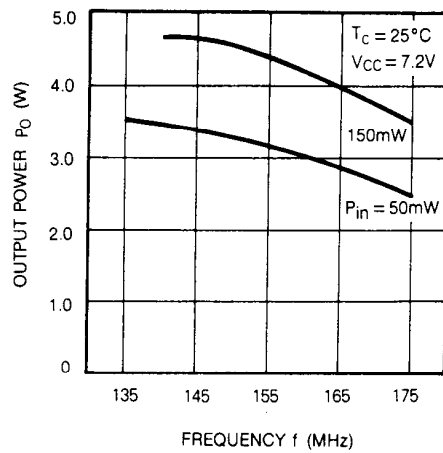

INPUT, OUTPUT IMPEDANCE VS. FREQUENCY CHARACTERISTICS

