

2SC4624

NPN EPITAXIAL PLANAR TYPE

DESCRIPTION

2SC4624 is a silicon NPN epitaxial planar type transistor specifically designed for RF power amplifiers in 800-900 MHz band range.

FEATURES

- High power gain : $G_{pe} \geq 4.7\text{dB}$, $P_o \geq 45\text{W}$
@ $V_{cc} = 12.5\text{V}$, $f = 900\text{MHz}$, $P_{in} = 15\text{W}$
- Emitter ballasted construction.
- High ruggedness : Ability to withstand 20 : 1 load VSWR when operated at $V_{cc} = 15.2\text{V}$, $P_o = 45\text{W}$, $f = 900\text{MHz}$.
- High reliability due to gold metalization die.
- Flange type ceramic package.
- Common emitter configuraion.

APPLICATIONS

RF power amplifiers in 800-900MHz band range, especially suitable for radio applications.

OUTLINE DRAWING

Dimension in mm

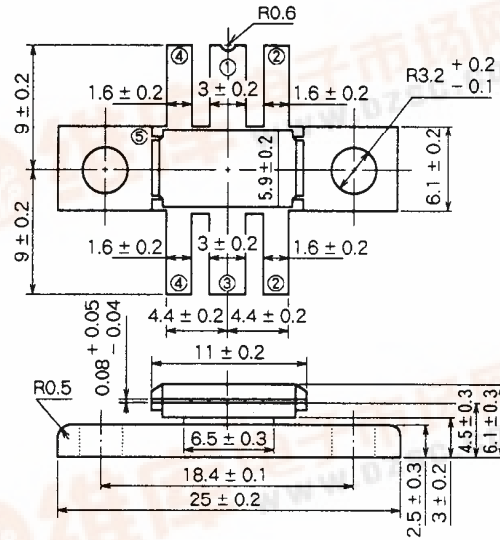

- PIN :
- ① COLLECTOR
 - ② EMITTER (FLANGE)
 - ③ BASE
 - ④ EMITTER (FLANGE)
 - ⑤ FIN (EMITTER)

T-44E

ABSOLUTE MAXIMUM RATINGS ($T_c = 25^\circ\text{C}$ unless otherwise noted)

Symbol	Parameter	Conditions	Ratings	Unit
V_{cbo}	Collector-base voltage		35	V
V_{ebo}	Emitter-base voltage		2.5	V
V_{ces}	Collector-emitter voltage	$R_{BE} = \infty$	16	V
I_c	Collector current		15	A
P_c	Collector dissipation	$T_c = 25^\circ\text{C}$	110	W
T_j	Junction temperature		175	$^\circ\text{C}$
T_{stg}	Storage temperature range		- 55 to 175	$^\circ\text{C}$
R_{th-c}	Thermal resistance	Junction to case	1.36	$\text{W}/^\circ\text{C}$

Note. Above parameters are guaranteed independently.

ELECTRICAL CHARACTERISTICS ($T_c = 25^\circ\text{C}$ unless otherwise noted)

Symbol	Parameter	Test conditions	Limits			Unit
			Min	Typ	Max	
$V_{(BR)EBO}$	Emitter-base breakdown voltage	$I_E = 10\text{mA}$, $I_C = 0$	2.5			V
$V_{(BR)CBO}$	Collector-base breakdown voltage	$I_C = 10\text{mA}$, $I_E = 0$	35			V
$V_{(BR)CEO}$	Collector-emitter breakdown voltage	$I_C = 100\text{mA}$, $R_{BE} = \infty$	16			V
I_{cbo}	Collector cutoff current	$V_{cb} = 15\text{V}$, $I_E = 0$			5000	μA
I_{ebo}	Emitter cutoff current	$V_{EB} = 2\text{V}$, $I_C = 0$			5000	μA
h_{FE}	DC forward current gain *	$V_{CE} = 10\text{V}$, $I_C = 1\text{A}$	10	50	180	-
P_o	Output power	$V_{cc} = 12.5\text{V}$, $P_{in} = 15\text{W}$, $f = 900\text{MHz}$	45	50		W
η_c	Collector efficiency		45	50		%

Note. Above parameters, ratings, limits and conditions are subject to change.



TEST CIRCUIT

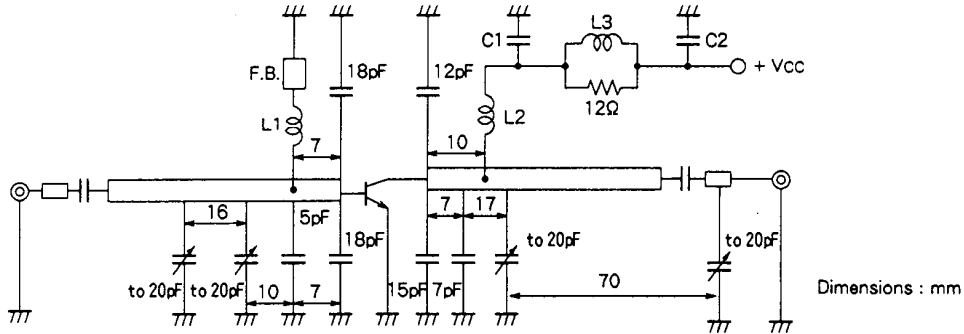

Z1, Z2, Z3, Z4: Microboard material 1.6mm thick glass-terflon $\epsilon r = 2.6$ 50 Ω - line
 C1: 100pF, 100pF, 1000pF, 22000pF in parallel
 C2: 1000pF, 22000pF, 100 μ F in parallel

L1: 2Turn, AWG # 13, 9.5mm I.D.
 L2: 1Turn, AWG # 13, 9.5mm I.D.
 L3: 6Turn, AWG # 20, 5mm I.D.

F.B.: Ferrite Bead

TYPICAL PERFORMANCE DATA

COLLECTOR DISSIPATION VS. CASE TEMPERATURE CHARACTERISTICS

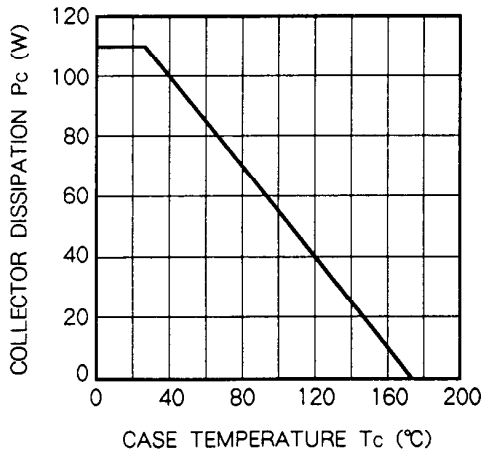

COLLECTOR CURRENT VS. COLLECTOR TO EMITTER VOLTAGE

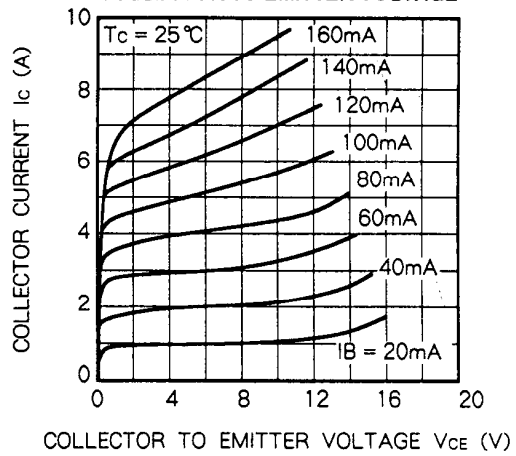

DC CURRENT GAIN VS. COLLECTOR CURRENT

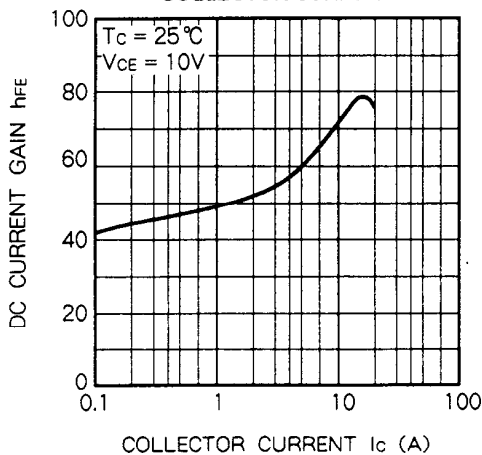

COLLECTOR OUTPUT CAPACITANCE VS. COLLECTOR TO BASE VOLTAGE

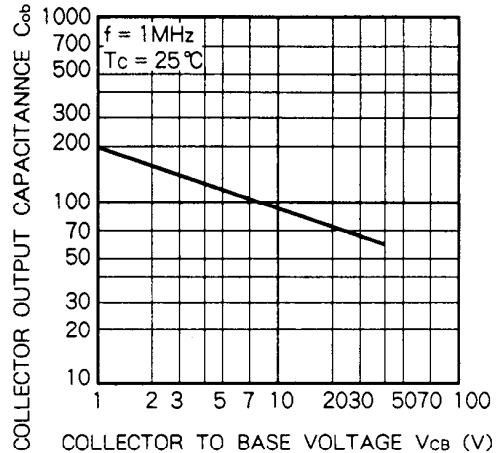

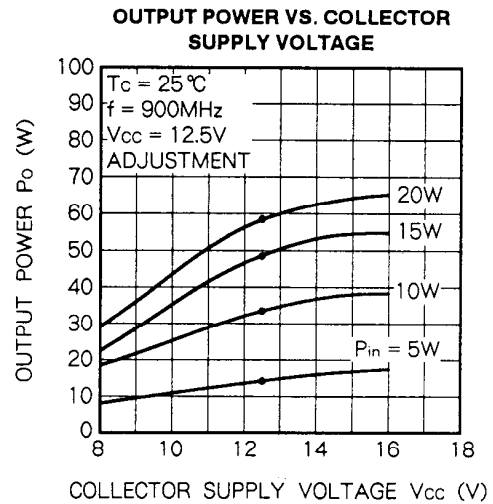
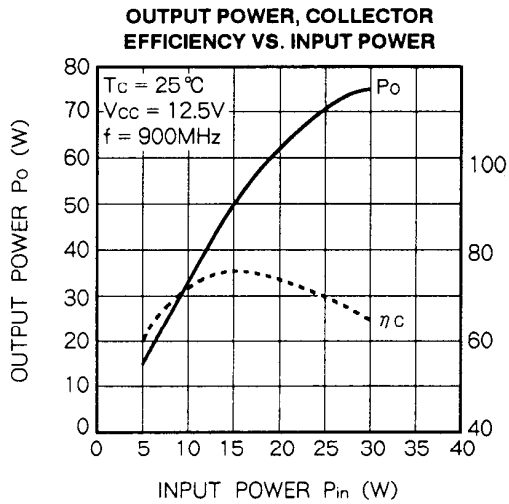

INPUT AND OUTPUT SERIES IMPEDANCE VS. FREQUENCY CHARACTERISTICS

$Z_o = 10\ \Omega$

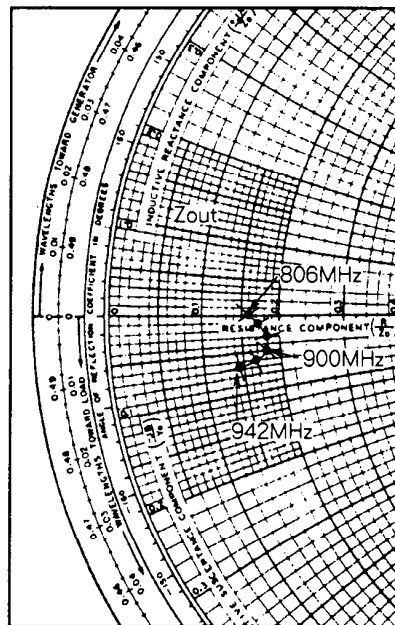
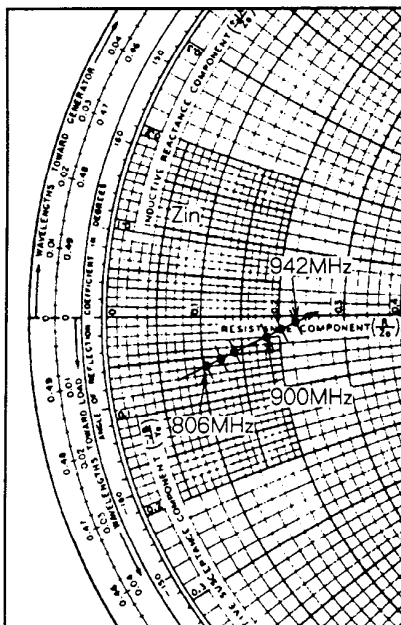

f (GHz)	Z_{in} (Ω)	Z_{out} (Ω)
806	$1.05 - j0.60$	$1.63 - j0.00$
840	$1.20 - j0.55$	$1.72 - j0.01$
870	$1.40 - j0.50$	$1.90 - j0.30$
900	$1.80 - j0.30$	$1.85 - j0.45$
920	$2.00 - j0.20$	$1.70 - j0.58$
942	$2.20 - j0.15$	$1.50 - j0.62$

CONDITIONS : $V_{cc} = 12.5\text{V}$, $P_o = 45\text{W}$