

2SK2939(L), 2SK2939(S)

Silicon N Channel MOS FET
High Speed Power Switching

HITACHI

ADE-208-562D (Z)
5th. Edition
June 1, 1998

Features

- Low on-resistance
 $R_{DS} = 0.020 \Omega$ typ.
- High speed switching
- 4V gate drive device can be driven from 5V source

Outline

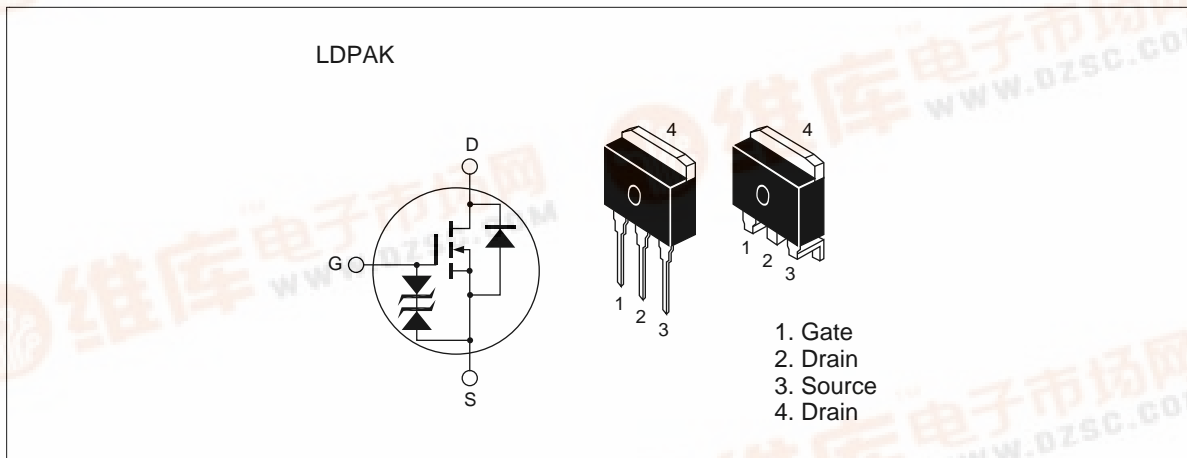

2SK2939(L), 2SK2939(S)

Absolute Maximum Ratings (Ta = 25°C)

Item	Symbol	Ratings	Unit
Drain to source voltage	V _{DSS}	60	V
Gate to source voltage	V _{GSS}	±20	V
Drain current	I _D	35	A
Drain peak current	I _{D(pulse)} ^{Note1}	140	A
Body-drain diode reverse drain current	I _{DR}	35	A
Avalanche current	I _{AP} ^{Note3}	35	A
Avalanche energy	E _{AR} ^{Note3}	105	mJ
Channel dissipation	P _{ch} ^{Note2}	50	W
Channel temperature	T _{ch}	150	°C
Storage temperature	T _{stg}	-55 to +150	°C

- Note: 1. PW ≤ 10μs, duty cycle ≤ 1 %
2. Value at Tc = 25°C
3. Value at Tch = 25°C, Rg ≥ 50Ω

2SK2939(L), 2SK2939(S)

Electrical Characteristics (Ta = 25°C)

Item	Symbol	Min	Typ	Max	Unit	Test Conditions
Drain to source breakdown voltage	$V_{(BR)DSS}$	60	—	—	V	$I_D = 10\text{mA}$, $V_{GS} = 0$
Gate to source breakdown voltage	$V_{(BR)GSS}$	± 20	—	—	V	$I_G = \pm 100\mu\text{A}$, $V_{DS} = 0$
Gate to source leak current	I_{GSS}	—	—	± 10	μA	$V_{GS} = \pm 16\text{V}$, $V_{DS} = 0$
Zero gate voltage drain current	I_{DSS}	—	—	10	μA	$V_{DS} = 60\text{V}$, $V_{GS} = 0$
Gate to source cutoff voltage	$V_{GS(off)}$	1.5	—	2.5	V	$I_D = 1\text{mA}$, $V_{DS} = 10\text{V}$
Static drain to source on state resistance	$R_{DS(on)}$	—	0.020	0.026	Ω	$I_D = 15\text{A}$, $V_{GS} = 10\text{V}$ ^{Note4}
	$R_{DS(on)}$	—	0.032	0.050	Ω	$I_D = 15\text{A}$, $V_{GS} = 4\text{V}$ ^{Note4}
Forward transfer admittance	$ y_{fs} $	14	23	—	S	$I_D = 15\text{A}$, $V_{DS} = 10\text{V}$ ^{Note4}
Input capacitance	C_{iss}	—	1100	—	pF	$V_{DS} = 10\text{V}$
Output capacitance	C_{oss}	—	540	—	pF	$V_{GS} = 0$
Reverse transfer capacitance	C_{rss}	—	200	—	pF	$f = 1\text{MHz}$
Turn-on delay time	$t_{d(on)}$	—	15	—	ns	$I_D = 15\text{A}$, $V_{GS} = 10\text{V}$
Rise time	t_r	—	180	—	ns	$R_L = 2\Omega$
Turn-off delay time	$t_{d(off)}$	—	175	—	ns	
Fall time	t_f	—	195	—	ns	
Body-drain diode forward voltage	V_{DF}	—	0.95	—	V	$I_F = 35\text{A}$, $V_{GS} = 0$
Body-drain diode reverse recovery time	t_{rr}	—	40	—	ns	$I_F = 35\text{A}$, $V_{GS} = 0$ $di_F/dt = 50\text{A}/\mu\text{s}$

Note: 4. Pulse test

2SK2939(L), 2SK2939(S)

Main Characteristics

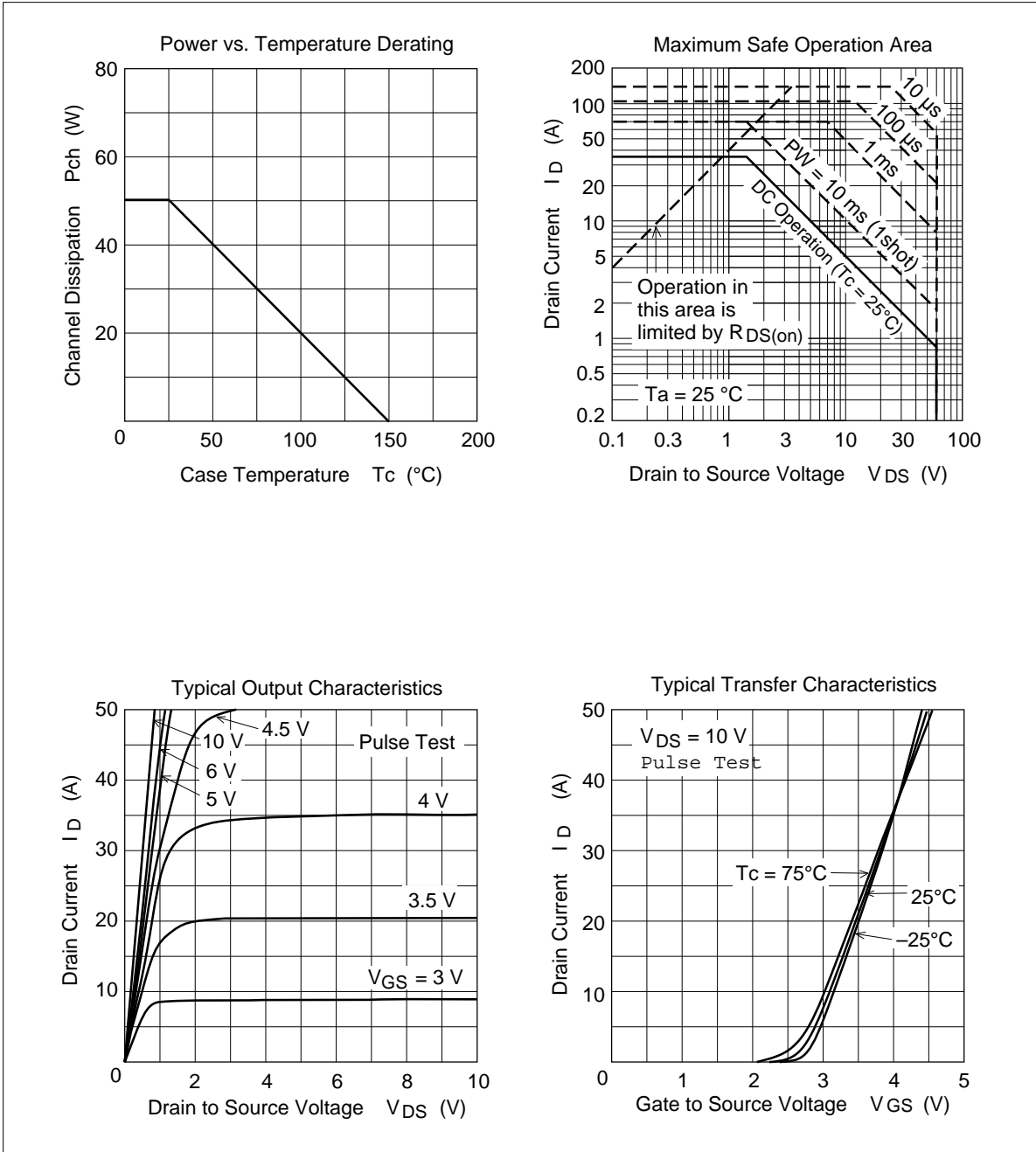

2SK2939(L), 2SK2939(S)

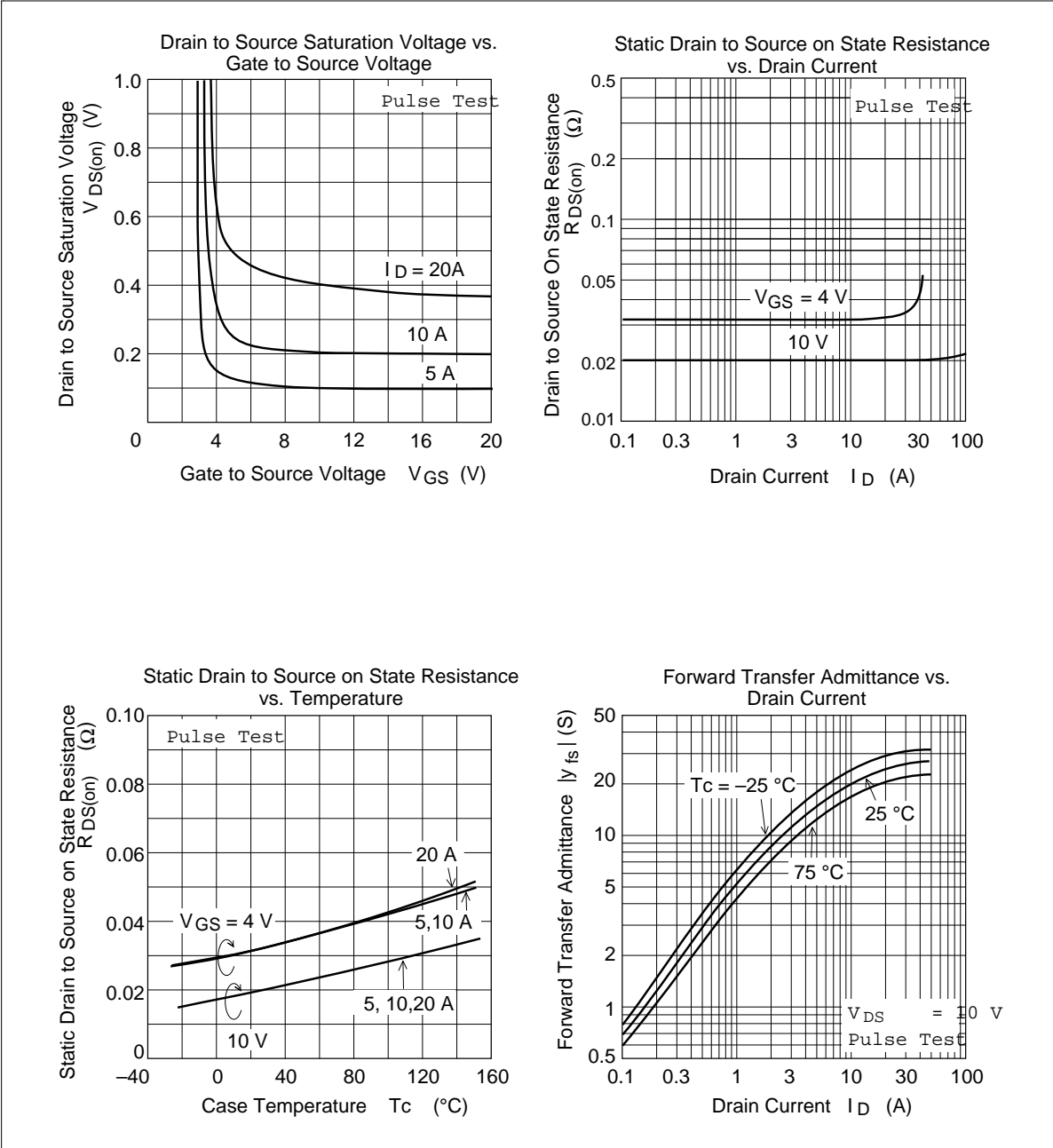

2SK2939(L), 2SK2939(S)

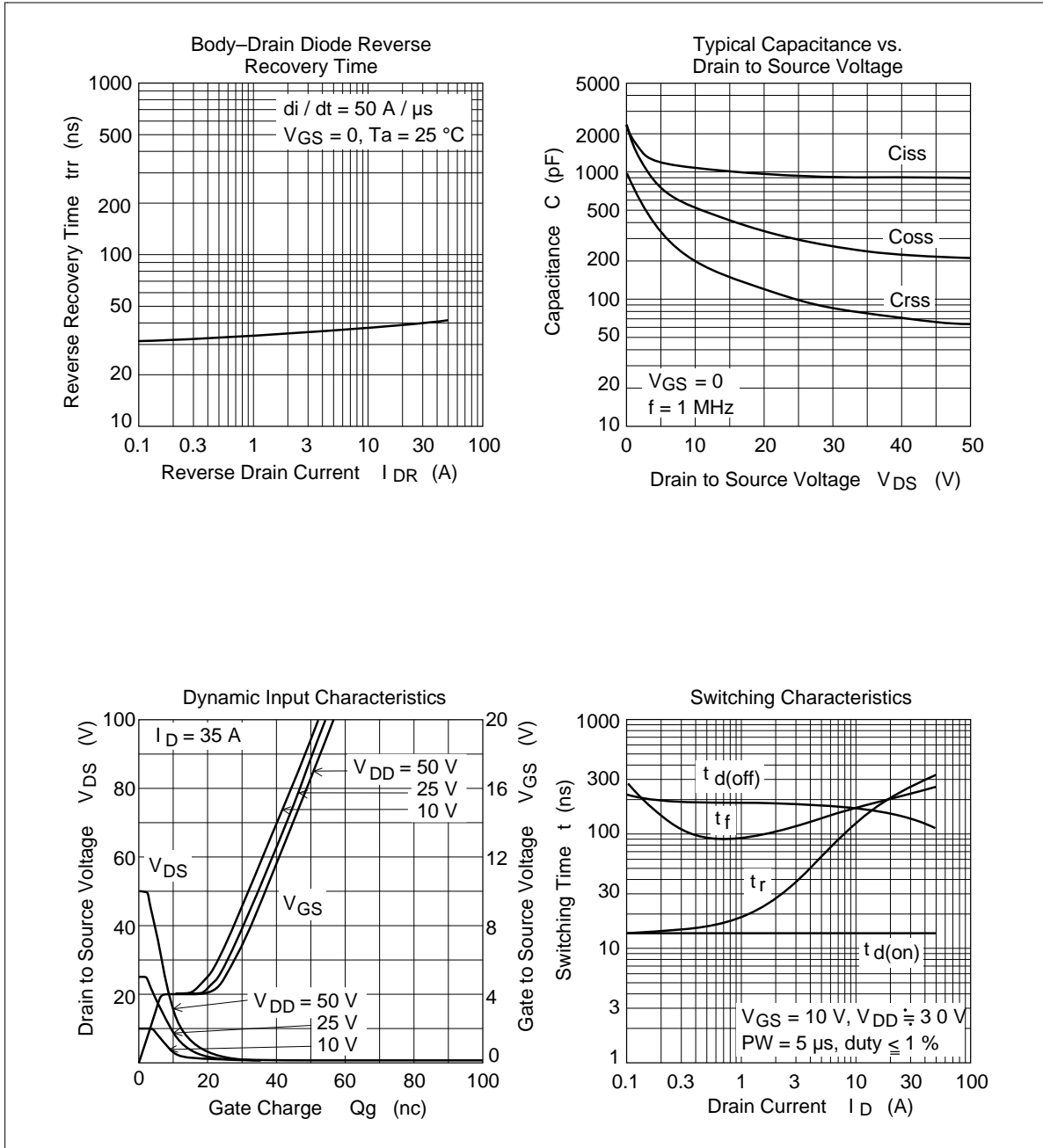

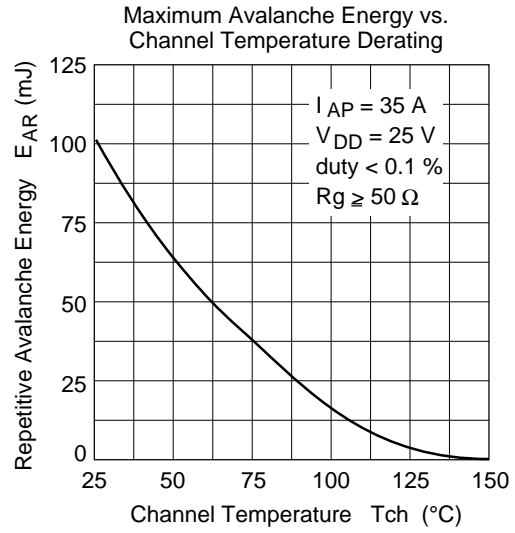
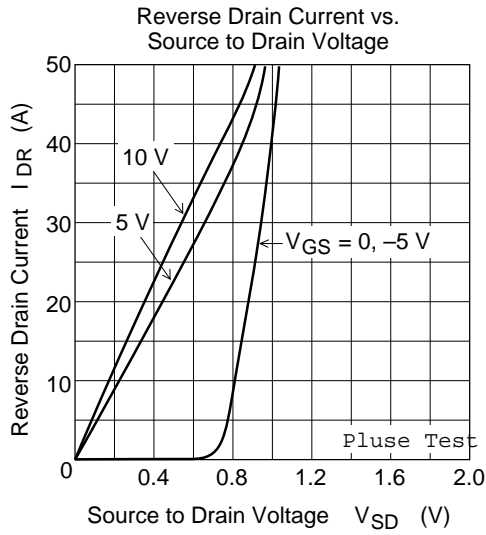

Avalanche Test Circuit

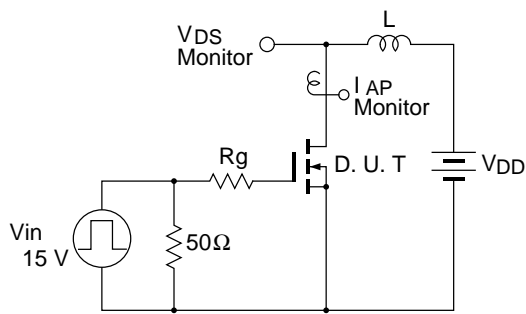

Avalanche Waveform

$$E_{AR} = \frac{1}{2} \cdot L \cdot I_{AP}^2 \cdot \frac{V_{DSS}}{V_{DSS} - V_{DD}}$$

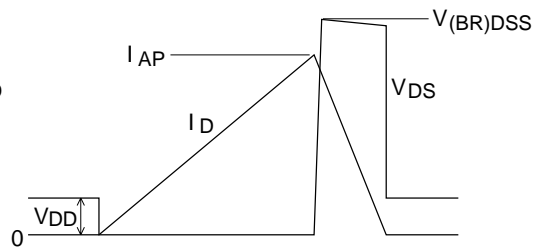

2SK2939(L), 2SK2939(S)

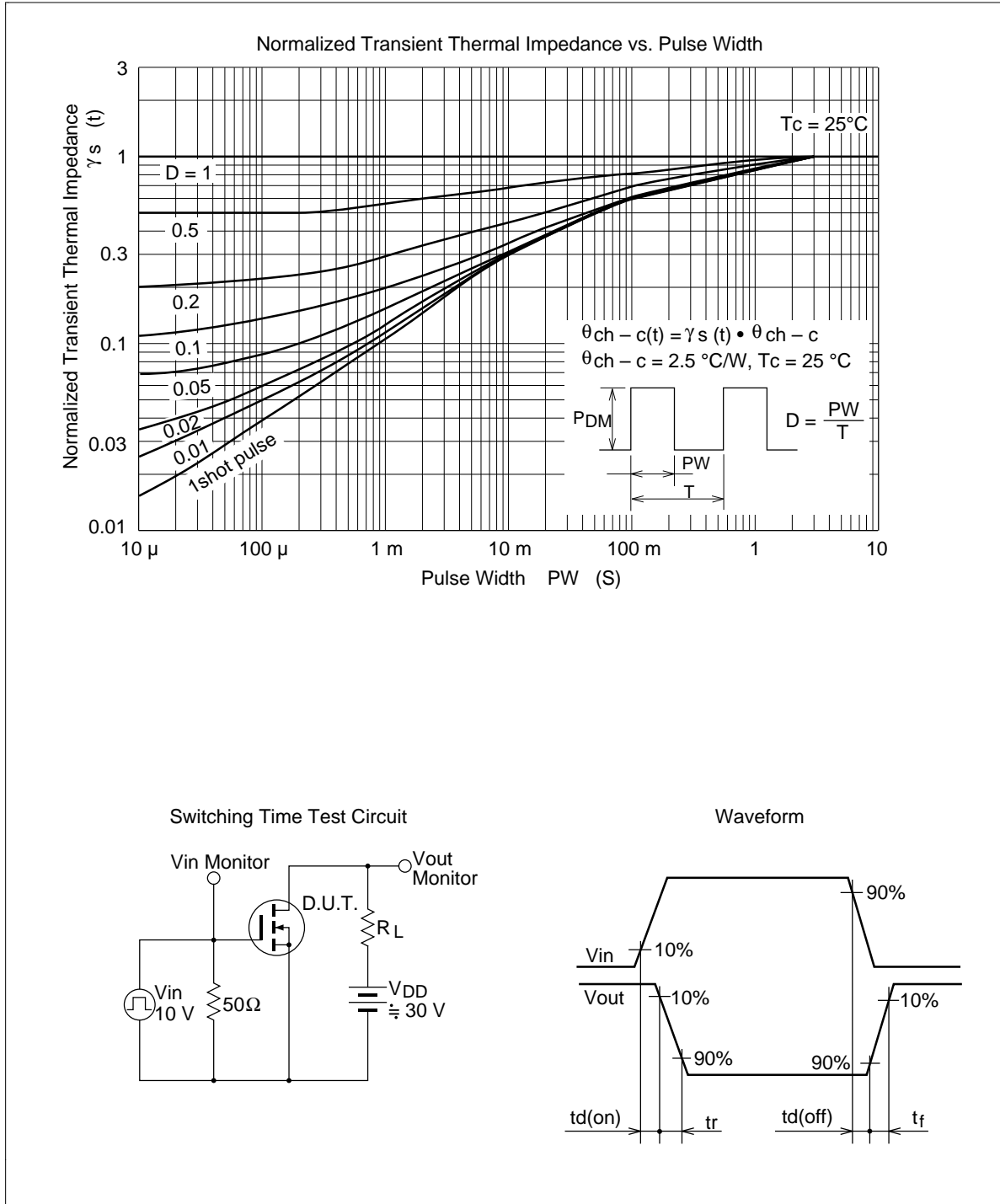

2SK2939(L), 2SK2939(S)

Package Dimensions (Unit: mm)

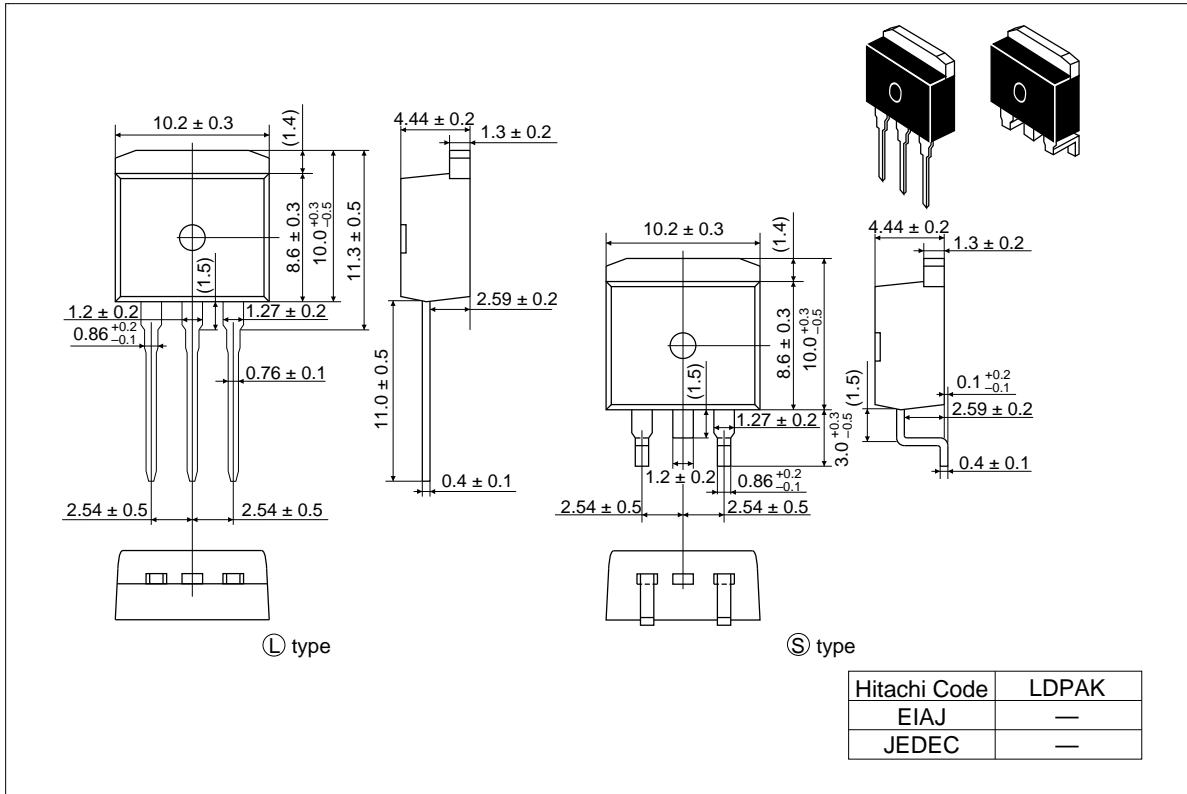

2SK2939(L), 2SK2939(S)

Cautions

1. Hitachi neither warrants nor grants licenses of any rights of Hitachi's or any third party's patent, copyright, trademark, or other intellectual property rights for information contained in this document. Hitachi bears no responsibility for problems that may arise with third party's rights, including intellectual property rights, in connection with use of the information contained in this document.
2. Products and product specifications may be subject to change without notice. Confirm that you have received the latest product standards or specifications before final design, purchase or use.
3. Hitachi makes every attempt to ensure that its products are of high quality and reliability. However, contact Hitachi's sales office before using the product in an application that demands especially high quality and reliability or where its failure or malfunction may directly threaten human life or cause risk of bodily injury, such as aerospace, aeronautics, nuclear power, combustion control, transportation, traffic, safety equipment or medical equipment for life support.
4. Design your application so that the product is used within the ranges guaranteed by Hitachi particularly for maximum rating, operating supply voltage range, heat radiation characteristics, installation conditions and other characteristics. Hitachi bears no responsibility for failure or damage when used beyond the guaranteed ranges. Even within the guaranteed ranges, consider normally foreseeable failure rates or failure modes in semiconductor devices and employ systemic measures such as fail-safes, so that the equipment incorporating Hitachi product does not cause bodily injury, fire or other consequential damage due to operation of the Hitachi product.
5. This product is not designed to be radiation resistant.
6. No one is permitted to reproduce or duplicate, in any form, the whole or part of this document without written approval from Hitachi.
7. Contact Hitachi's sales office for any questions regarding this document or Hitachi semiconductor products.

HITACHI

Hitachi, Ltd.

Semiconductor & IC Div.

Nippon Bldg., 2-6-2, Ohte-machi, Chiyoda-ku, Tokyo 100-0004, Japan

Tel: Tokyo (03) 3270-2111

Fax: (03) 3270-5109

For further information write to:

Hitachi Semiconductor

(America) Inc.

2000 Sierra Point Parkway

Brisbane, CA. 94005-1897

U S A

Tel: 800-285-1601

Fax: 303-297-0447

Hitachi Europe GmbH

Continental Europe

Dornacher Straße 3

D-85622 Feldkirchen

München

Tel: 089-9 91 80-0

Fax: 089-9 29 30-00

Hitachi Europe Ltd.

Electronic Components Div.

Northern Europe Headquarters

Whitebrook Park

Lower Cookham Road

Maidenhead

Berkshire SL6 8YA

United Kingdom

Tel: 01628-585000

Fax: 01628-585160

Hitachi Asia Pte. Ltd.

16 Collyer Quay #20-00

Hitachi Tower

Singapore 049318

Tel: 535-2100

Fax: 535-1533

Hitachi Asia (Hong Kong) Ltd.

Unit 706, North Tower,

World Finance Centre,

Harbour City, Canton Road

Tsim Sha Tsui, Kowloon

Hong Kong

Tel: 27359218

Fax: 27306071

Copyright © Hitachi, Ltd., 1998. All rights reserved. Printed in Japan.