

PF0310

MOS FET Power Amplifier Module for VHF Band

HITACHI

ADE-208-103B (Z)
3rd. Edition
July 1996

Application

VHF Band 136 to 150 MHz

Features

- Small package: $30 \times 10 \times 5.9$ mm
- High efficiency: 50% Typ
- Low power control current: 0.5 mA Max

Pin Arrangement

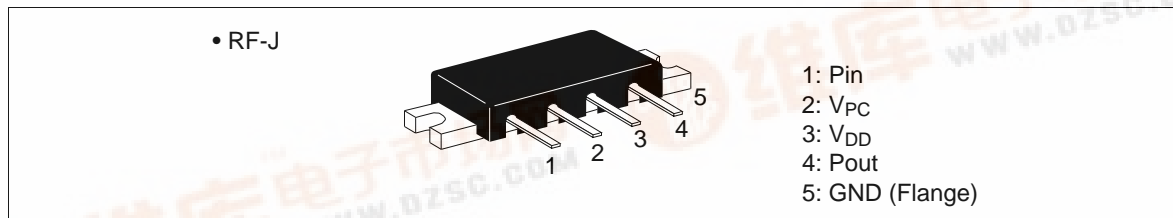

PF0310

Internal Diagram and External Circuit

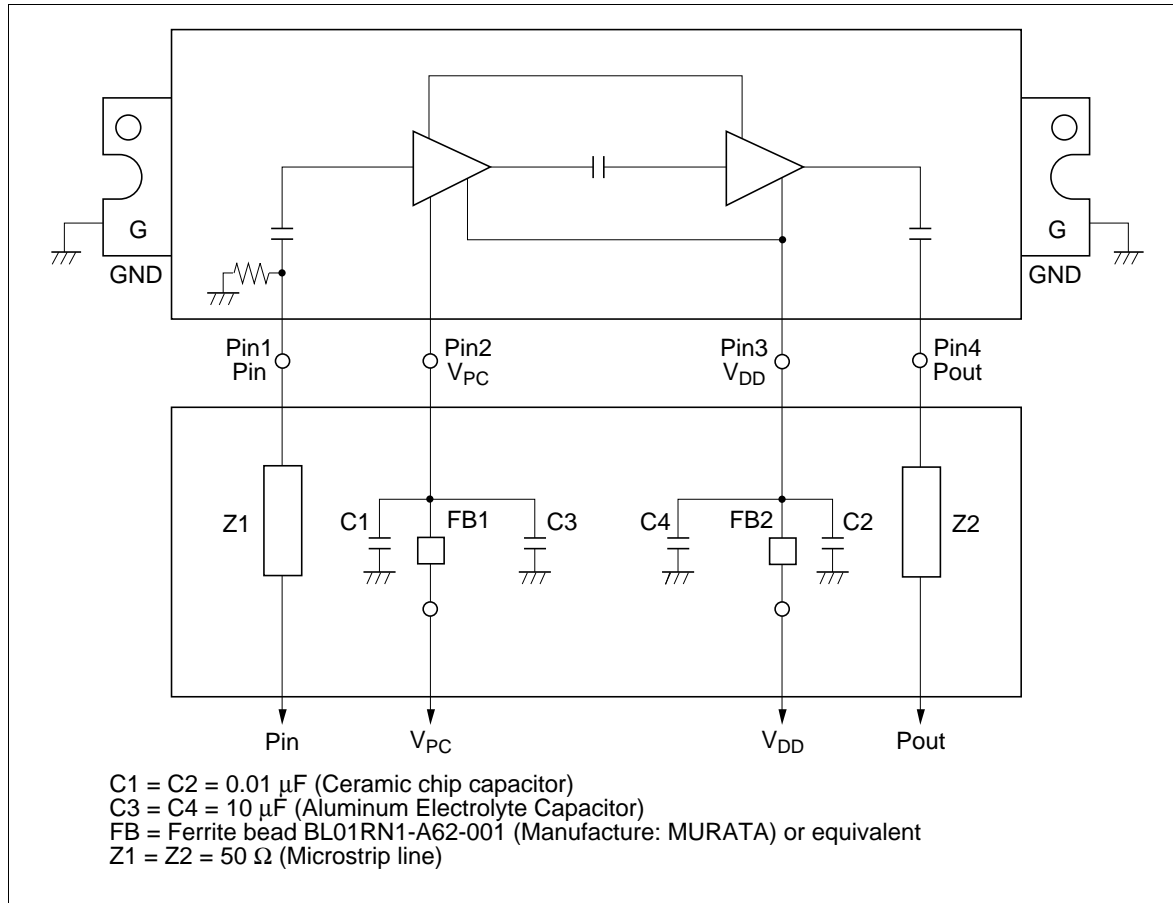

Absolute Maximum Ratings ($T_c = 25^\circ\text{C}$)

Item	Symbol	Rating	Unit
Supply voltage	VDD	17	V
Supply current	IDD	3	A
PC voltage	VPC	7	V
Input power	Pin	50	mW
Operating case temperature	T_c (op)	-30 to +100	$^\circ\text{C}$
Storage temperature	T_{stg}	-40 to +110	$^\circ\text{C}$

Electrical Characteristics ($T_c = 25^\circ\text{C}$)

Item	Symbol	Min	Typ	Max	Unit	Test Condition
Frequency range	f	136	—	150	MHz	—
Drain cutoff current	I_{DS}	—	—	100	μA	$V_{DD} = 17\text{ V}$, $V_{PC} = 0\text{ V}$
Total efficiency	η_T	45	50	—	%	$P_{in} = 20\text{ mW}$, $V_{DD} = 9.6\text{ V}$,
2nd harmonic distortion	2nd H.D.	—	-25	-20	dBc	$P_{out} = 7\text{ W}$ (at VAPC controlled),
3rd harmonic distortion	3rd H.D.	—	-35	-30	dBc	$R_L = R_g = 50\ \Omega$, $T_c = 25^\circ\text{C}$
4th harmonic distortion	4th H.D.	—	-40	-30	dBc	
Input VSWR	VSWR (in)	—	1.5	3	—	
Output VSWR	VSWR (out)	—	1.5	—	—	
Output power (1)	$P_{out} (1)$	7	8	—	W	$P_{in} = 20\text{ mW}$, $V_{DD} = 9.6\text{ V}$, $V_{PC} = 6\text{ V}$, $R_L = R_g = 50\ \Omega$
Output power (2)	$P_{out} (2)$	2.5	3	—	W	$P_{in} = 20\text{ mW}$, $V_{DD} = 6\text{ V}$, $V_{PC} = 5.5\text{ V}$, $R_L = R_g = 50\ \Omega$
Load VSWR tolerance	—	No degradation		—	—	$P_{in} = 20\text{ mW}$, $V_{DD} = 15\text{ V}$, $P_{out} \leq 7\text{ W}$, (VPC controlled), Output VSWR = 6:1 All phases
Stability	—	No parasitic oscillation		—	—	$P_{in} = 20\text{ mW}$, $V_{DD} = 6\text{ to }15\text{ V}$, $P_{out} \leq 7\text{ W}$, (VPC controlled), Output VSWR = 3:1 All phases

Test System Diagram

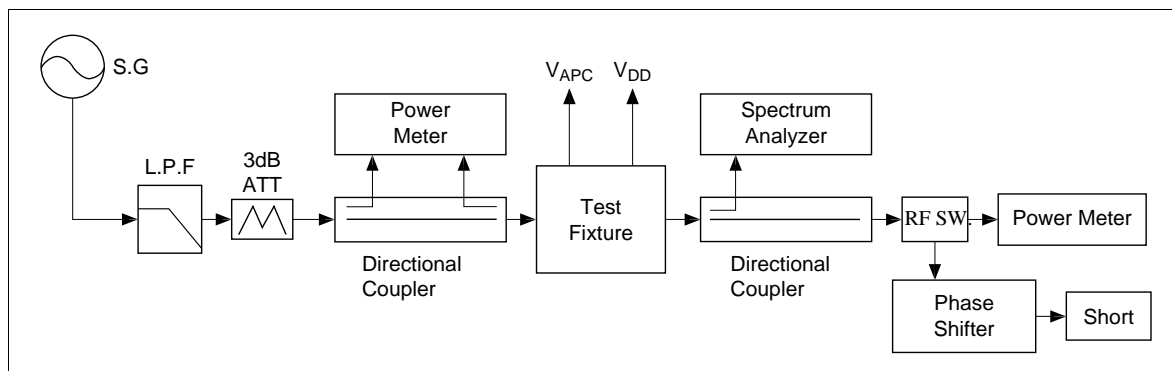

PF0310

Test Fixture Pattern

Unit: mm

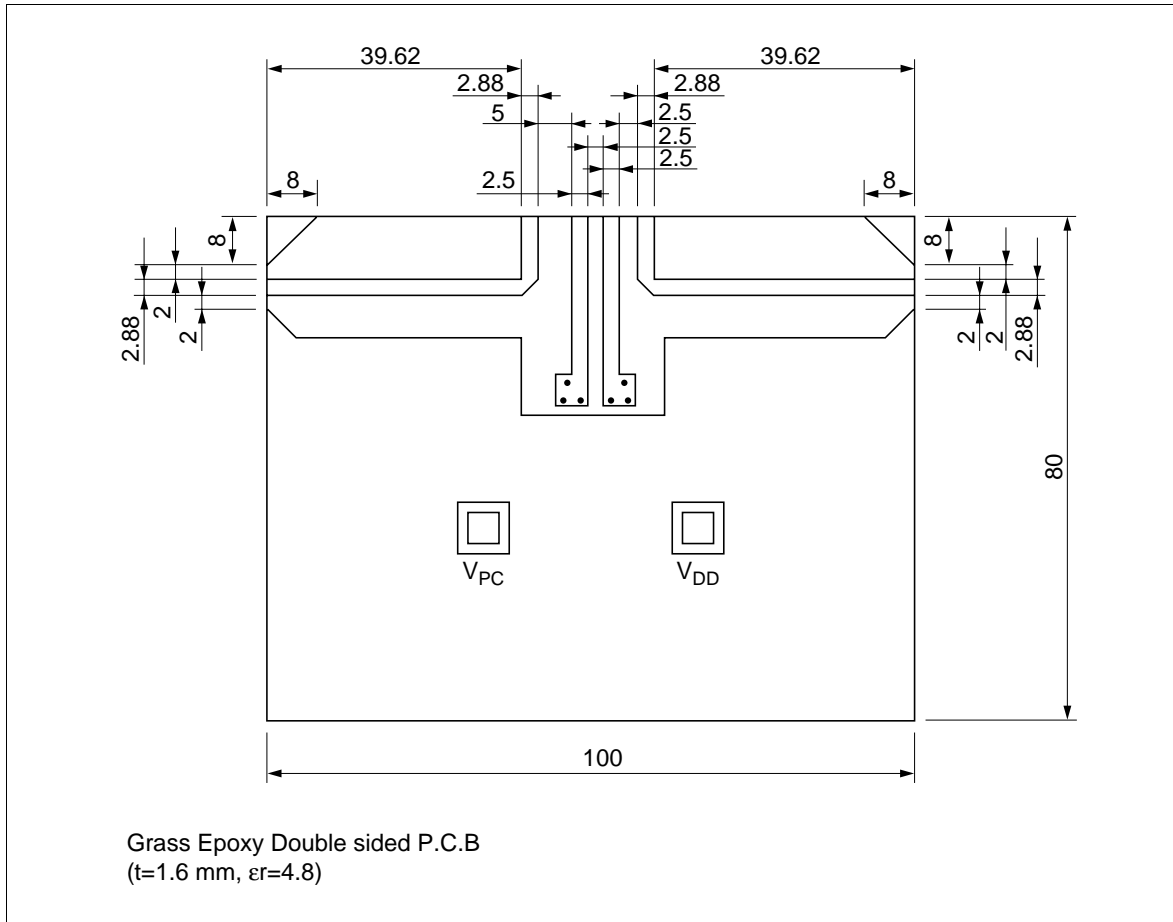

Mechanical Characteristics

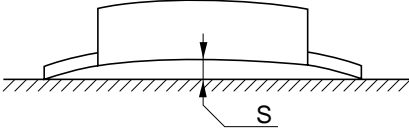
Item	Measuring Conditions	Spec
Torque for screw up the heatsink flange	M2.6 Screw Bolts	1.5 to 3.5 kg•cm
Warp size of the heatsink flange: S		S = 0 +0.1/-0 mm

Note for Use

- Unevenness and distortion at the surface of the heatsink attached module should be less than 0.05 mm.
- It should not be existed any dust between module and heatsink.
- Torque for screw up the heatsink flange should be 1.5 to 3.5 kg · cm with M2.6 screw bolts.
- Don't solder the flange directly.
- Soldering temperature and soldering time should be less than 230°C, 10 sec.
(Soldering position spaced from the root point of the lead frame: 2 mm).
- It should not be given mechanical and thermal stress to lead and flange of the module.
- To protect devices from electro-static damage, soldering iron, measuring-equipment and human body etc. should be grounded.
- Don't washing the module except lead pins.
- When the external parts (Isolator, Duplexer, etc.) of the module are changed, the electrical characteristics should be evaluated enough.
- To get good stability, ground impedance between the module GND flange and PCB GND pattern should be designed as low as possible.

PF0310

Characteristics Curve

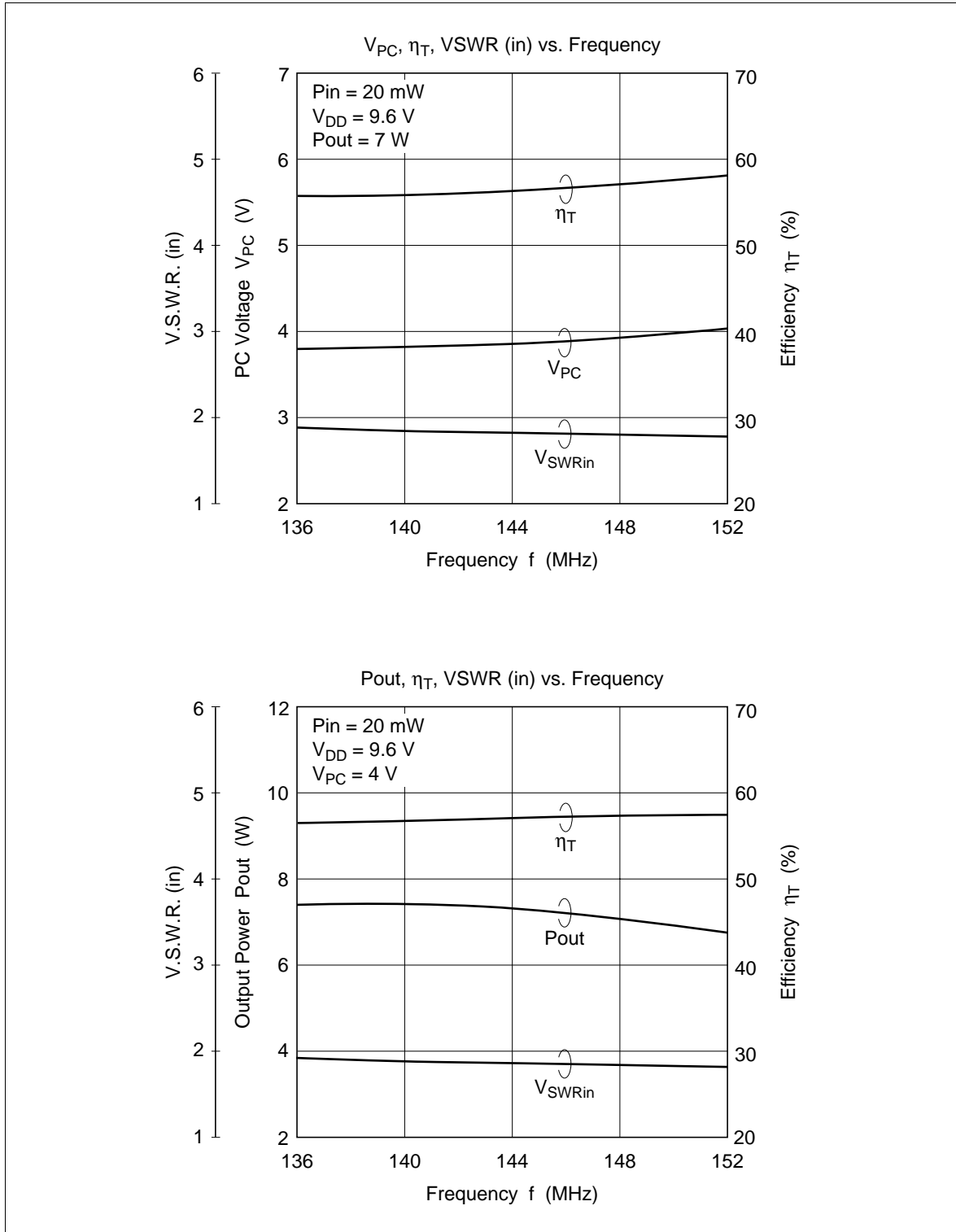

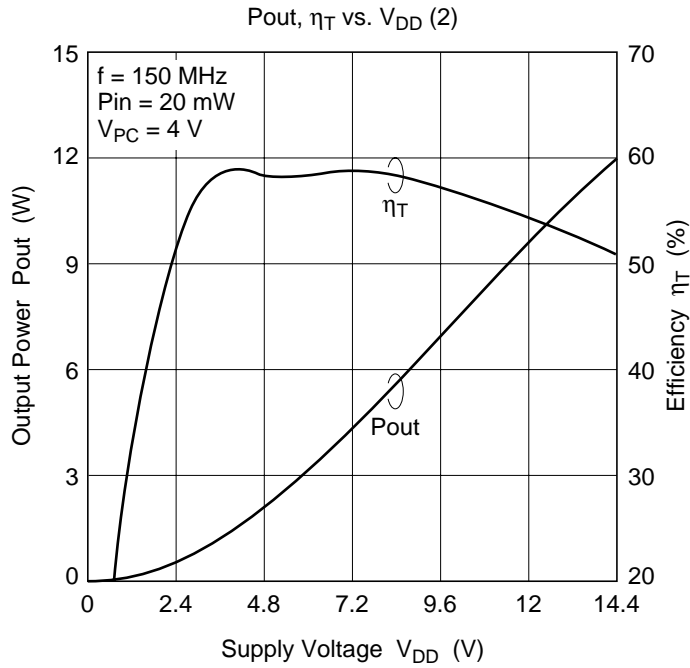
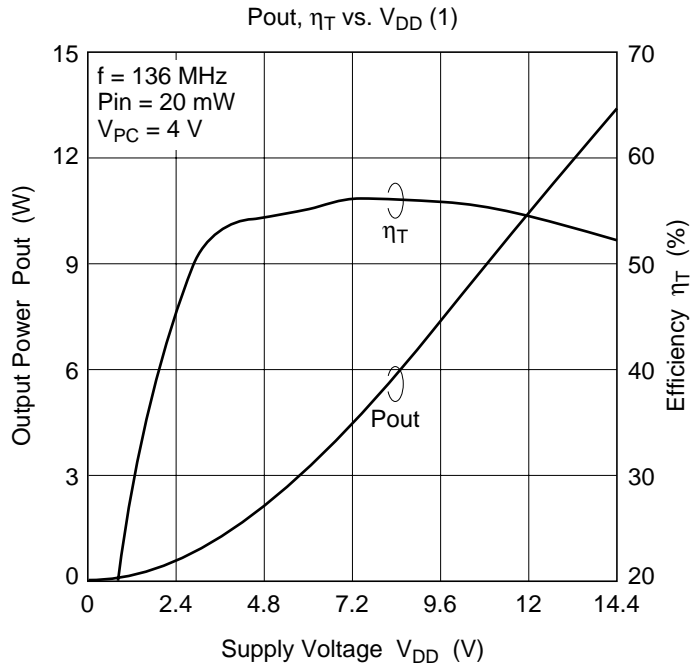

PF0310

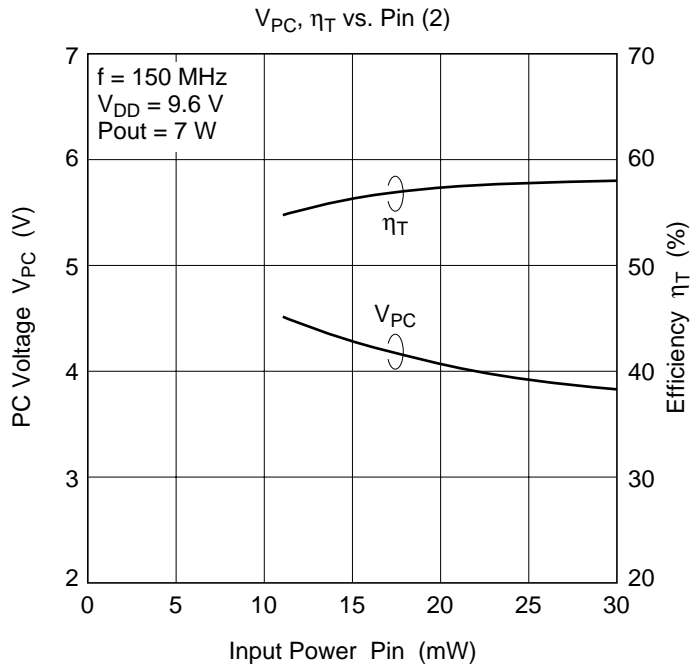
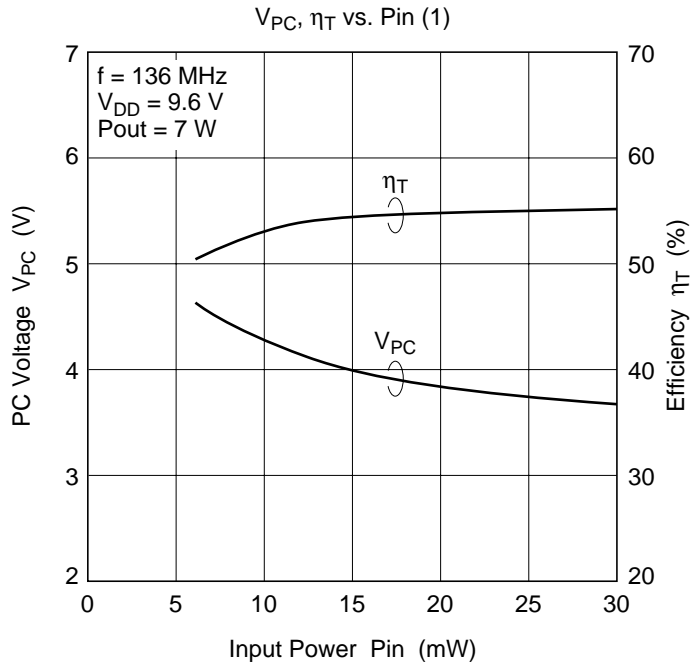

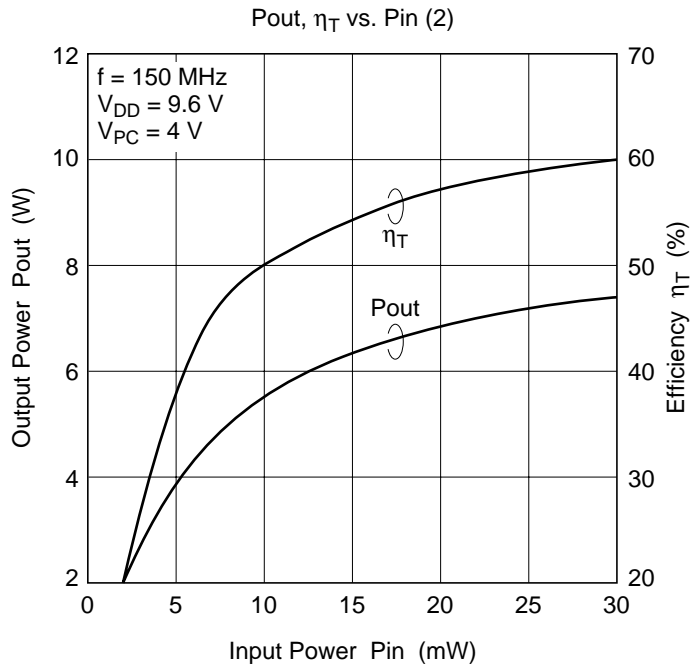
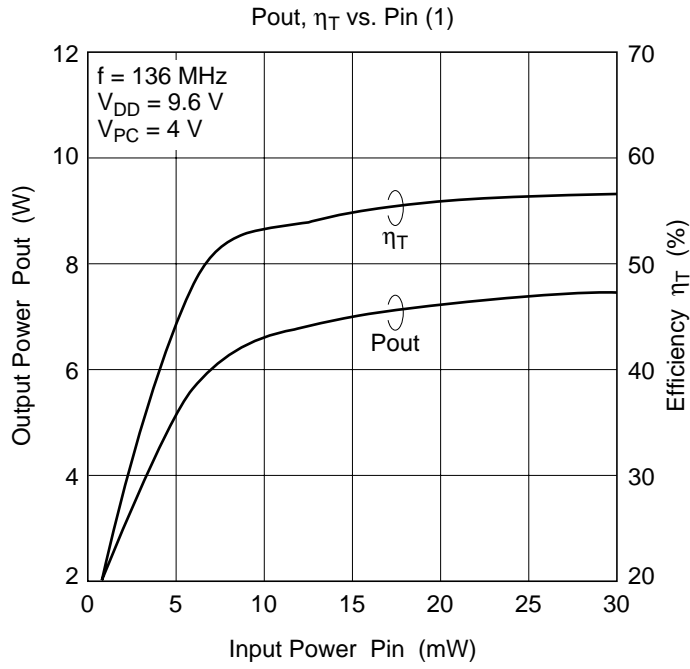

PF0310

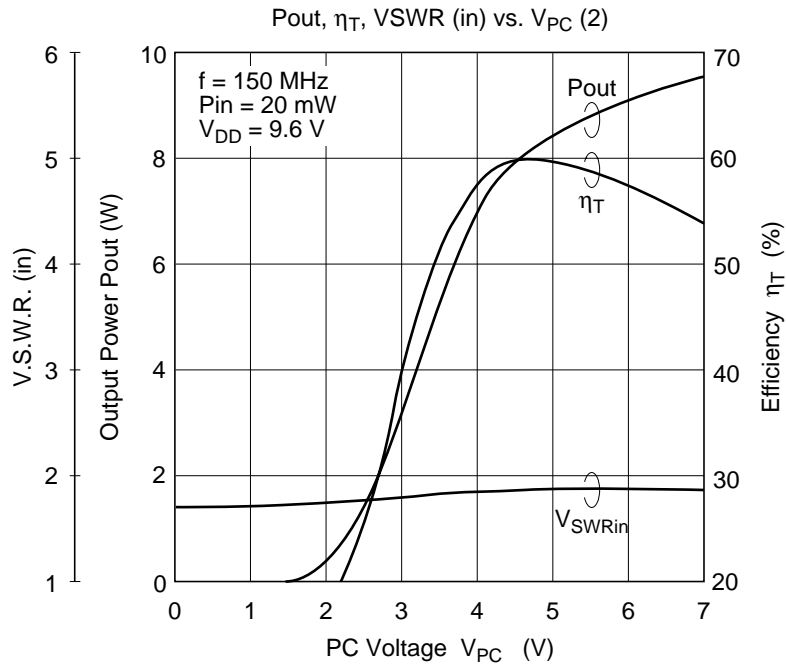
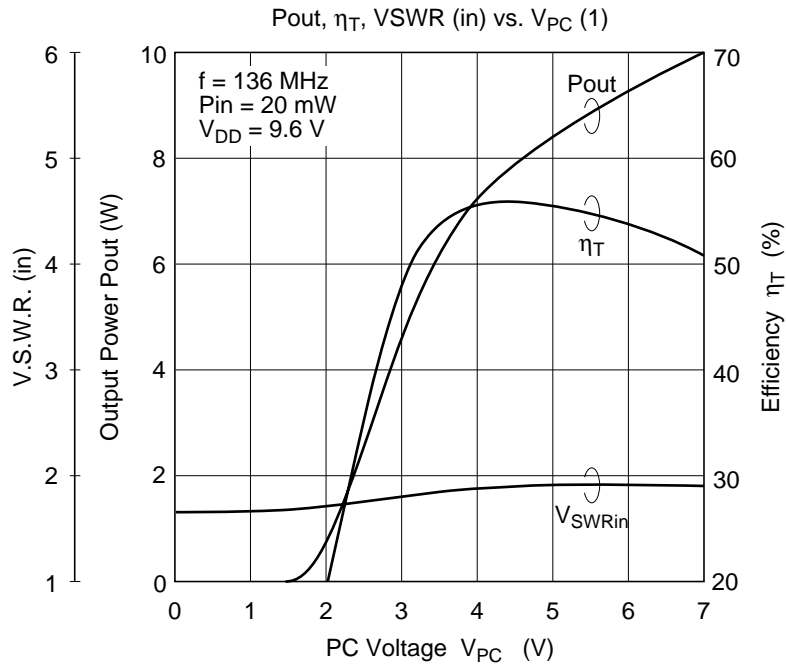

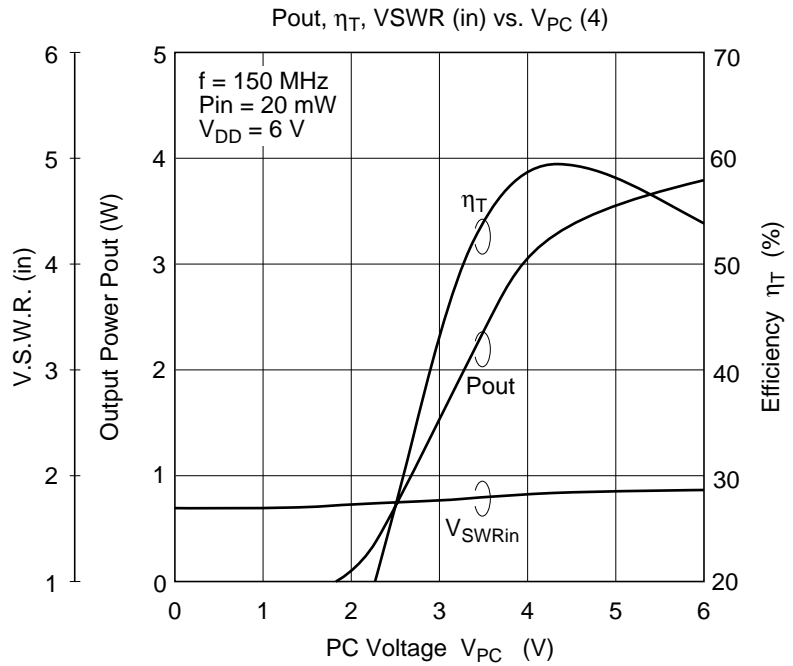
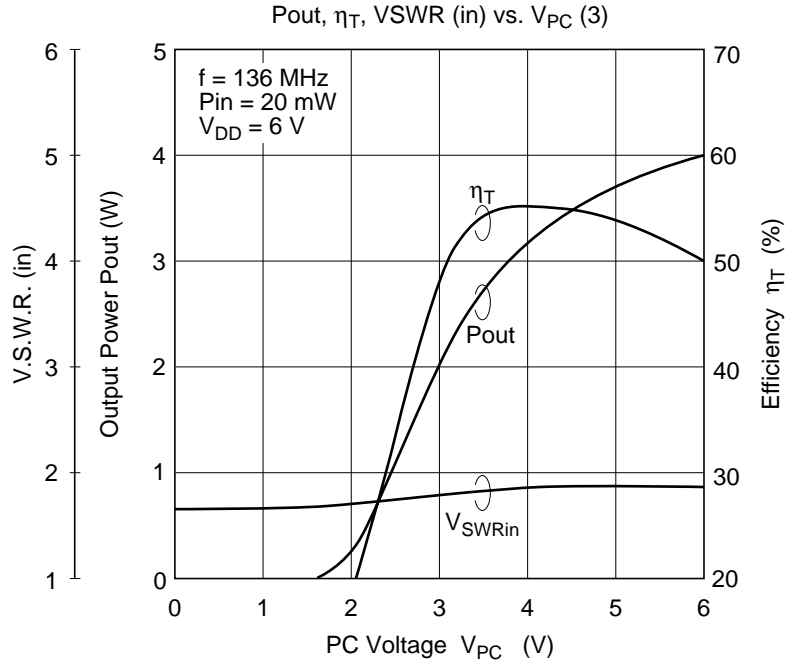

PF0310

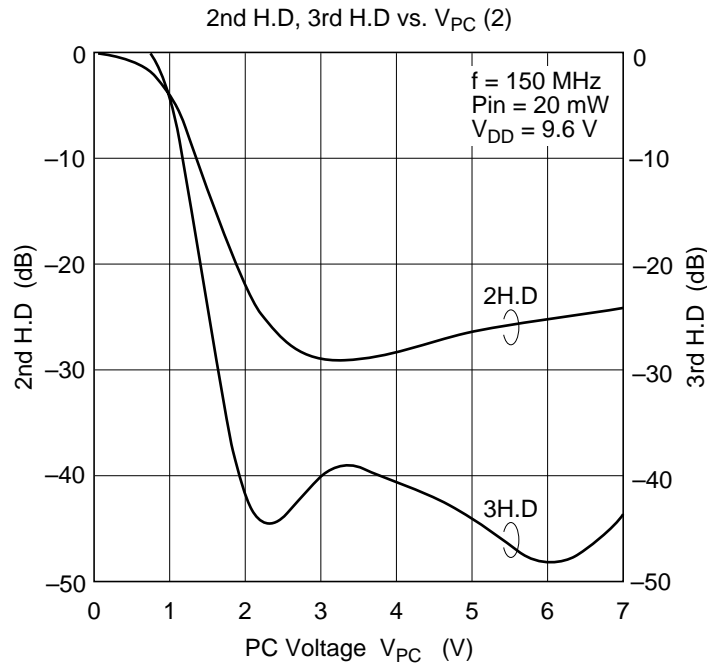
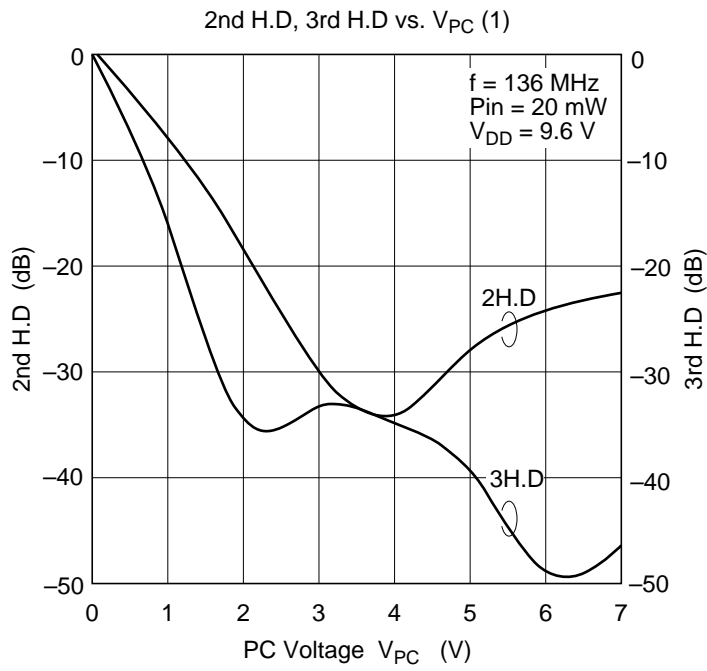

Package Dimensions

Unit: mm

