

PF0045A/PF0065A

MOS FET Power Amplifier Module for AMPS Handy Phone

HITACHI

ADE-208-309B (Z)
Preliminary 3rd. Edition
July 1996

Features

- High efficiency
PF0045A: 58 % Typ at 1.2 W
PF0065A: 52 % Typ at 1.2 W
- Low voltage operation: 4.8 V
- High power gain: 1 mW input
- Low power control current: 500 μ A Typ
- Reflowable surface mounted small package: 1 cc, 3 g

Pin Arrangement

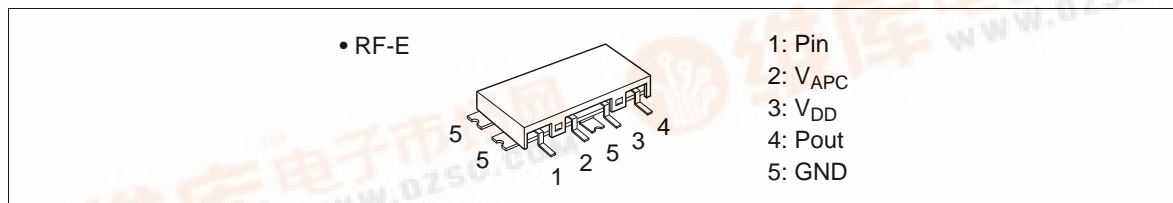

PF0045A/PF0065A

Internal Diagram and External Circuit

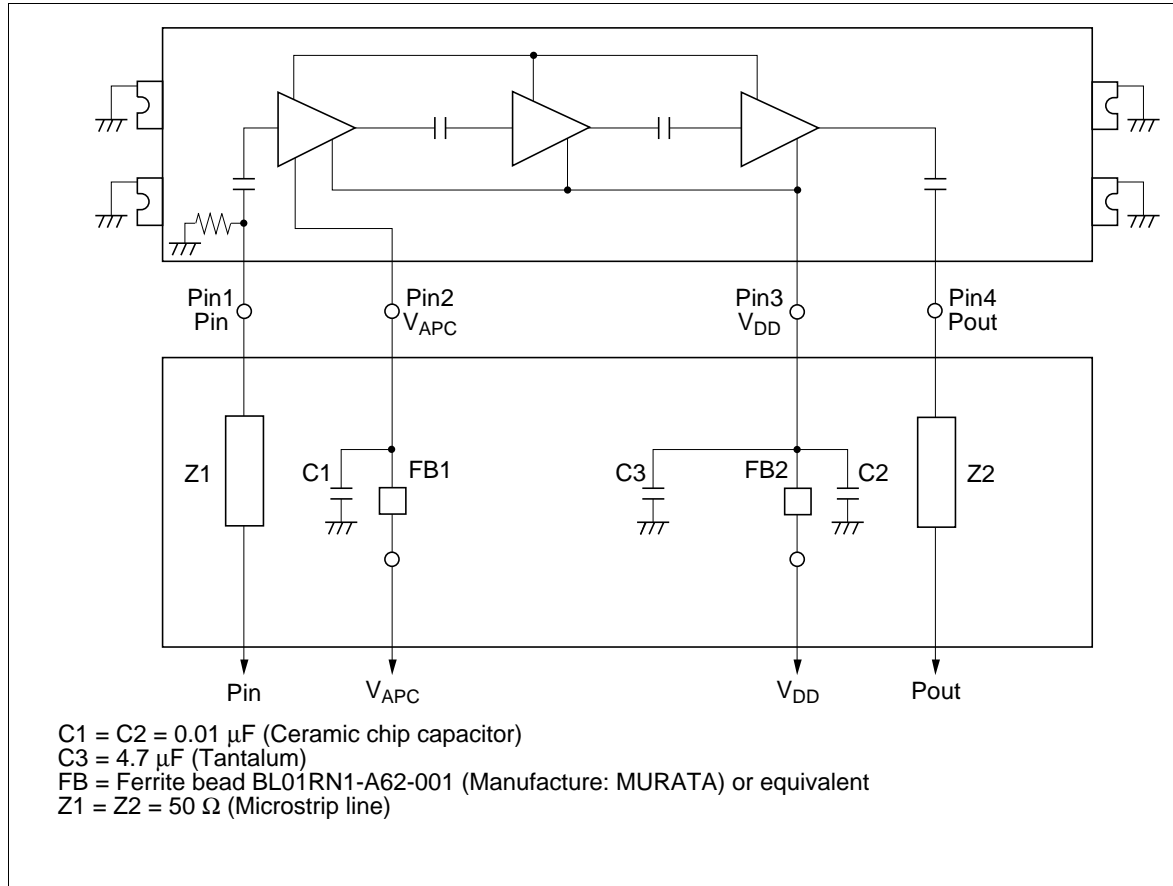

Absolute Maximum Ratings ($T_c = 25^\circ\text{C}$)

Item	Symbol	Rating	Unit
Supply voltage	VDD	10	V
Supply current	IDD	1.5	A
VAPC voltage	VAPC	4.5	V
Input power	Pin	20	mW
Operating case temperature	T_c (op)	-30 to +100	$^\circ\text{C}$
Storage temperature	T_{stg}	-30 to +100	$^\circ\text{C}$

PF0045A/PF0065A

Electrical Characteristics ($T_c = 25^\circ\text{C}$)

Item	Symbol	Min	Typ	Max	Unit	Test Condition
Drain cutoff current	IDS	—	—	100	μA	VDD = 10 V, VAPC = 0 V, RL = Rg = 50 Ω
Total efficiency (PF0045A) η_T		53	58	—	%	f = 824, 849 MHz,
Total efficiency (PF0065A) η_T		48	52	—	%	Pin = 1 mW, VDD = 4.8 V,
2nd harmonic distortion	2nd H.D.	—	-35	-30	dBc	Pout = 1.2 W (at VAPC controlled),
3rd harmonic distortion	3rd H.D.	—	-40	-30	dBc	RL = Rg = 50 Ω
Input VSWR	VSWR (in)	—	2	3	—	
Output power	Pout	1.25	1.4	—	W	f = 824, 849 MHz, Pin = 1 mW, VDD = 4.8 V, VAPC = 4 V, RL = Rg = 50 Ω
Isolation	—	—	-40	-35	dBm	f = 824, 849 MHz, Pin = 1 mW, VDD = 4.8 V, VAPC = 0.5 V, RL = Rg = 50 Ω
Stability	—	No parasitic oscillation		—	—	f = 824 to 849 MHz, Pin = 1 mW, VDD = 4.3 to 6 V, Pout \leq 1.4 W, Rg = 50 Ω , Load VSWR = 3:1 All phases angles
Load VSWR tolerance	—	No degradation		—	—	f = 824 to 849 MHz, Pin = 1 mW, t = 10 sec., VDD = 4.3 to 6 V, Pout \leq 1.4 W, Rg = 50 Ω , Load VSWR = 20:1 All phases angles

PF0045A/PF0065A

Characteristics Curve

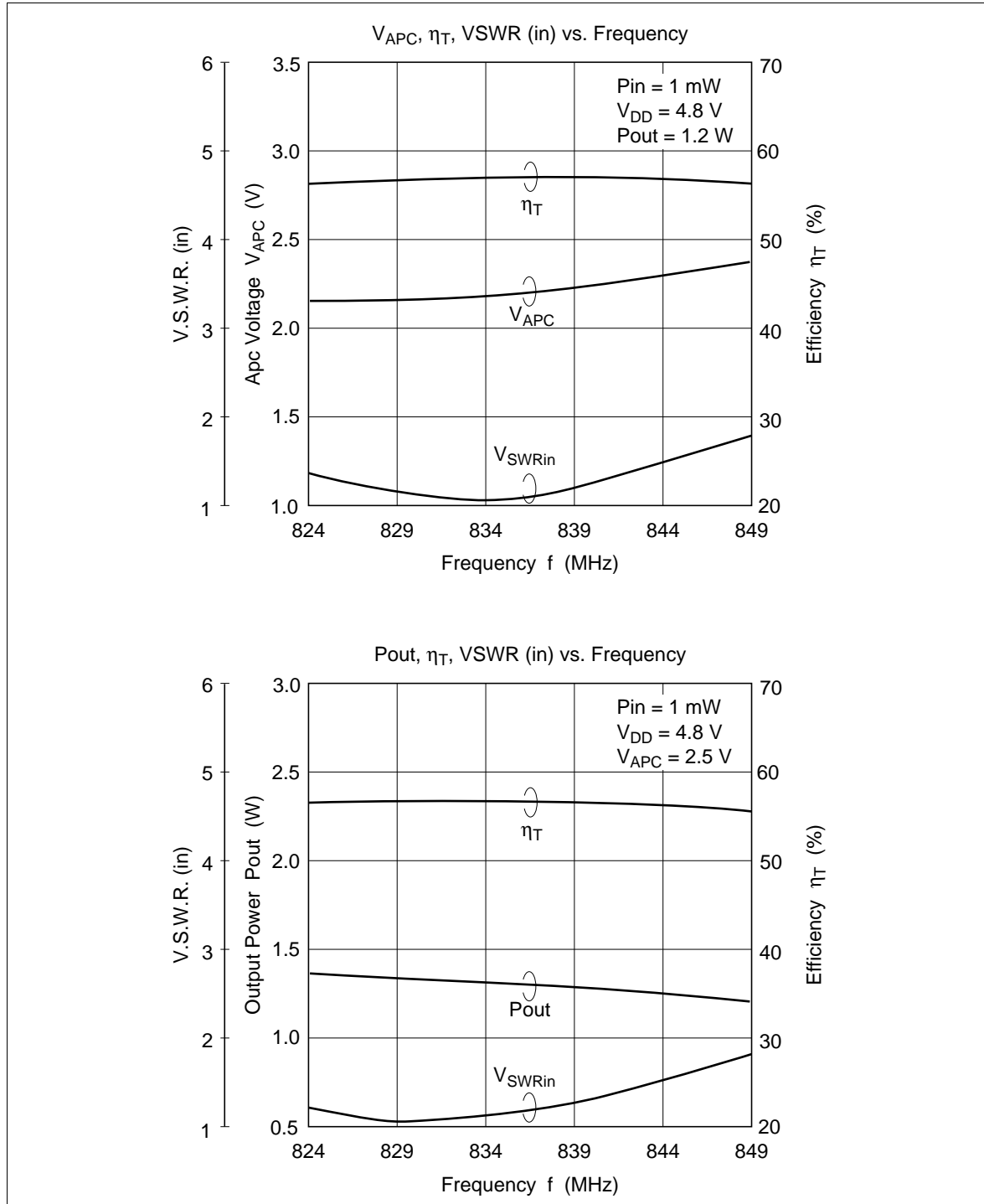

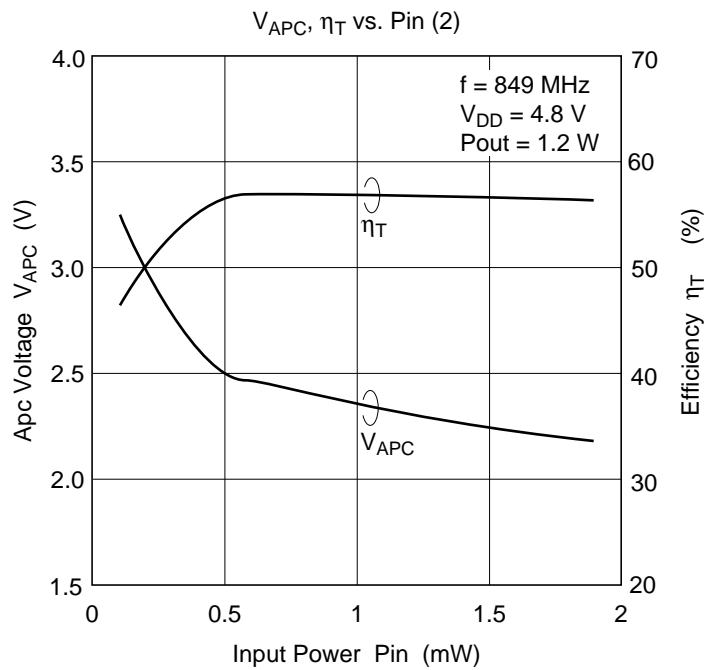
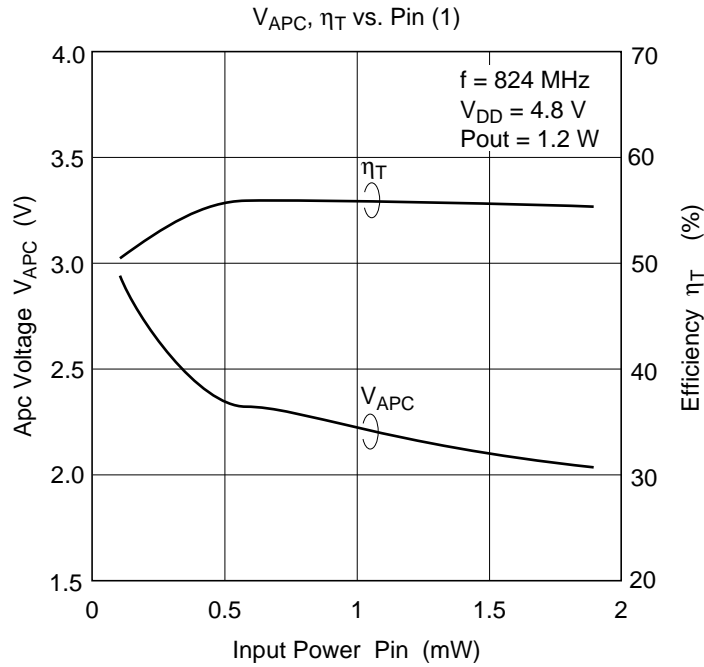

PF0045A/PF0065A

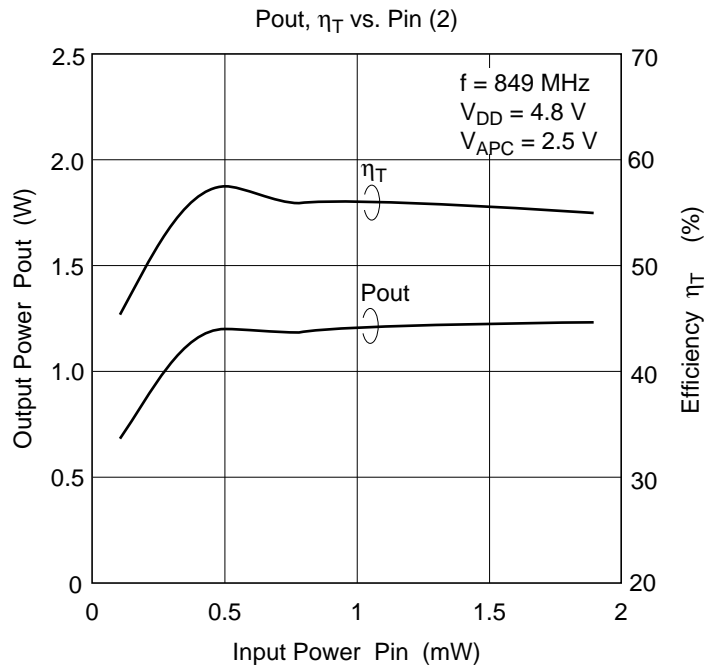
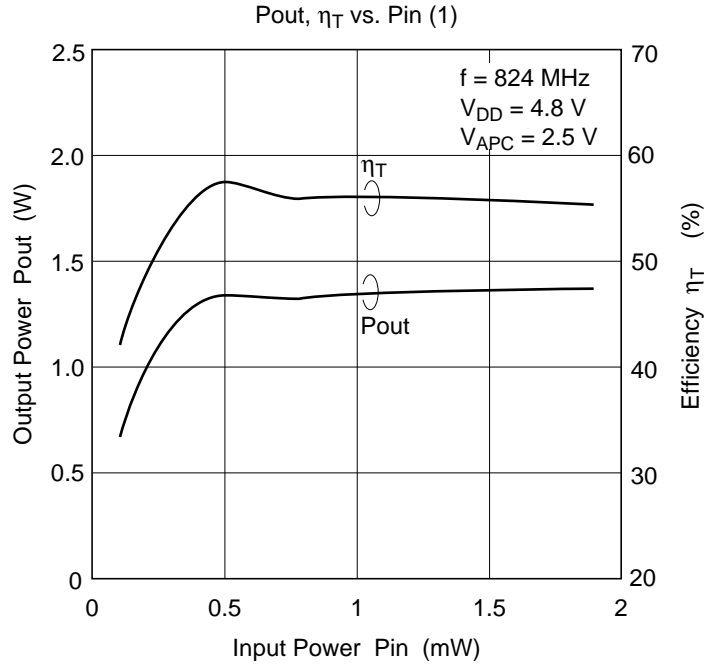

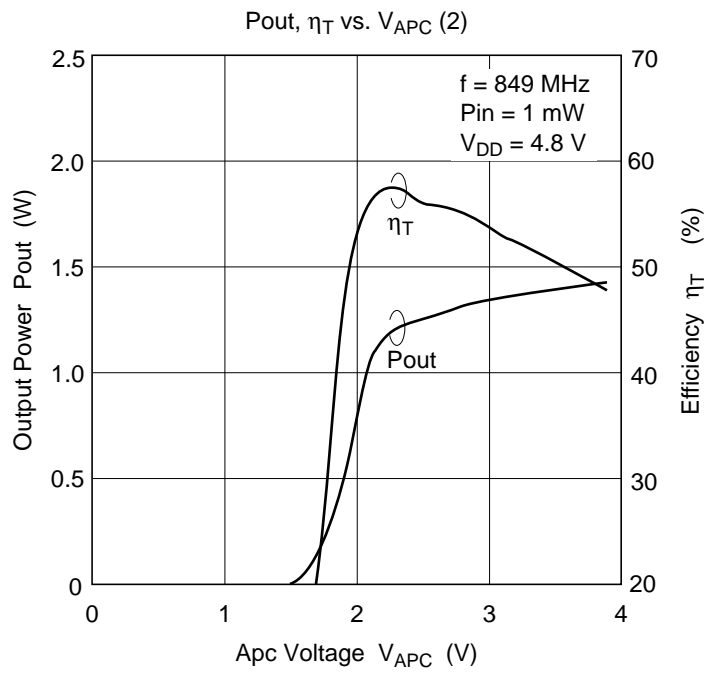
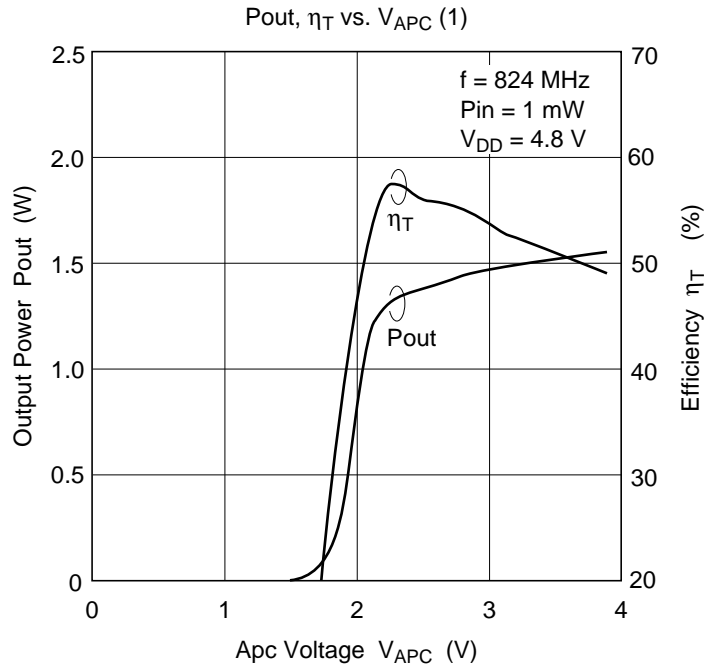

PF0045A/PF0065A

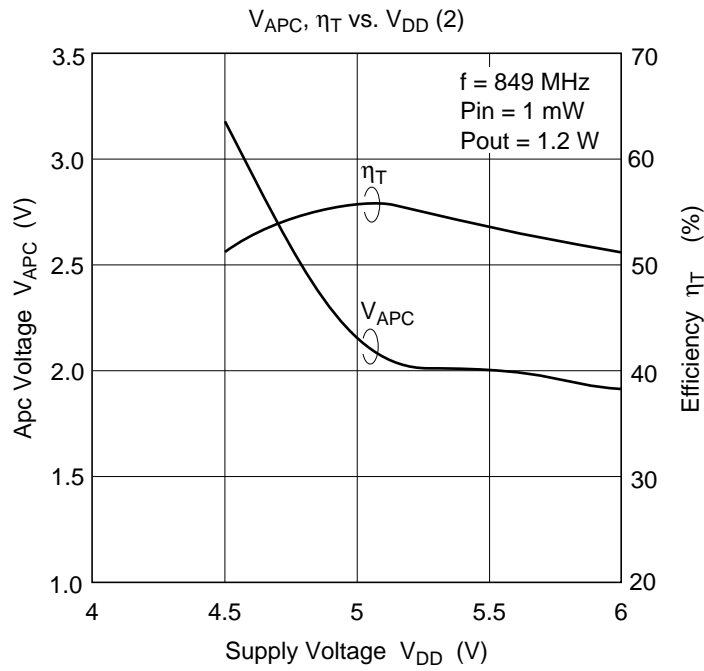
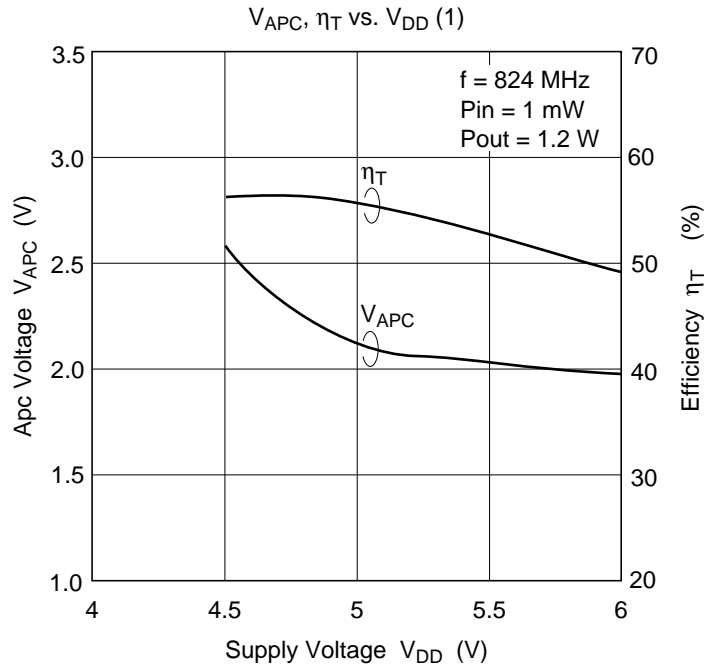

PF0045A/PF0065A

Package Dimensions

Unit: mm

