

3

**HEXADECIMAL-TO-SEVEN SEGMENT LATCH/  
 DECODER LED DRIVER**

The MC14495-1 is constructed with CMOS enhancement-mode devices and NPN bipolar output drivers in a monolithic structure. The circuit provides the functions of a 4-bit storage latch. The decoder is implemented utilizing a mask-programmable ROM. With a 5-volt power supply, it can be used without resistor interface to drive seven segment LEDs. The series output resistors of, typically, 290 ohms are internal to the device.

Applications include MPU systems display driver, instrument display driver, computer/calculator display driver, clockpit display driver, and various clock, watch, and timer uses.

- Low Logic-Circuit Power Dissipation
- High Current-Sourcing Outputs with Internal Limiting Resistors
- Latch Storage of Code
- Supply Voltage Range=4.5 to 18 V
- CMOS Input Switching Levels
- Standard ROM Provides Hex-to-Seven Segment Decoding
- Other ROM Options Available Upon Request (Contact your Motorola Sales Office)
- Chip Complexity: 187 FETs plus 9 NPNs or 49 Equivalent Gates

**MC14495-1**

**CMOS MSI**

(LOW-POWER COMPLEMENTARY MOS)

**HEXADECIMAL-TO-SEVEN  
 SEGMENT LATCH/DECODER  
 LED DRIVER**

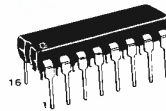

P SUFFIX  
 PLASTIC DIP  
 CASE 648

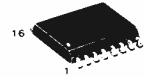

DW SUFFIX  
 SOG  
 CASE 751G

**ORDERING INFORMATION**

MC14495P1  
 MC14495DW1

Plastic DIP  
 SOG Package

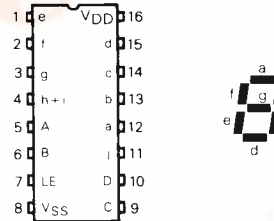

**ALPHANUMERIC DISPLAY**

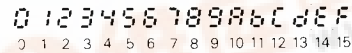

**TRUTH TABLE (LE = Low)**

INPUTS				OUTPUTS							DISPLAY	
D	C	B	A	a	b	c	d	e	f	g		h+i
0	0	0	0	1	1	1	1	1	0	0	Open	0
0	0	0	1	0	1	1	0	0	0	0	Open	1
0	0	1	0	1	1	0	1	1	0	1	Open	2
0	0	1	1	1	1	1	0	0	1	0	Open	3
0	1	0	0	0	1	1	0	0	1	1	Open	4
0	1	0	1	1	0	1	1	0	1	1	Open	5
0	1	1	0	1	0	1	1	1	1	1	Open	6
0	1	1	1	1	1	1	0	0	0	0	Open	7
1	0	0	0	1	1	1	1	1	1	1	Open	8
1	0	0	1	1	1	1	0	1	1	1	Open	9
1	0	1	0	1	1	0	1	1	1	1	Open	A
1	0	1	1	0	0	1	1	1	1	1	Open	b
1	1	0	0	1	0	0	1	1	1	0	Open	C
1	1	0	1	0	1	1	0	1	1	1	Open	d
1	1	1	0	1	0	0	1	1	1	1	Open	E
1	1	1	1	1	0	0	0	1	1	1	0	F

**BLOCK DIAGRAM**

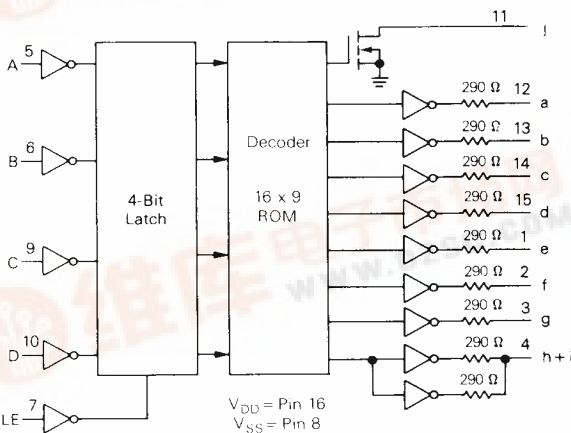

# MC14495-1

## MAXIMUM RATINGS (Voltages referenced to $V_{SS}$ )

Rating	Symbol	Value	Unit
DC Supply Voltage	$V_{DD}$	-0.5 to +18	V
Input Voltage, All Inputs	$V_{in}$	-0.5 to $V_{DD} + 0.5$	V
DC Current Drain per Input Pin	I	10	mA
Operating Temperature Range	$T_A$	-40 to +85	°C
Storage Temperature Range	$T_{stg}$	-65 to +150	°C
Maximum Continuous Output Power (Source) per Output @ 25°C Pins 1, 2, 3, 12, 13, 14, 15 Pin 4	$P_{OHmax}^\ddagger$	50 100	mW

This device contains circuitry to protect the inputs against damage due to high static voltages or electric fields, however, it is advised that normal precautions be taken to avoid application of any voltage higher than maximum rated voltages to this high impedance circuit. For proper operation it is recommended that  $V_{in}$  and  $V_{out}$  be constrained to the range  $V_{SS} \leq (V_{in} \text{ or } V_{out}) \leq V_{DD}$ .

3

$^\ddagger P_{OHmax} = I_{OH} (V_{DD} - V_{OH})$

## ELECTRICAL CHARACTERISTICS (Voltages referenced to $V_{SS}$ )

Characteristic	Symbol	$V_{DD}$ V	-40°C		25°C		85°C		Unit		
			Min	Max	Min	Typ #	Max	Min		Max	
Input Voltage "0" Level ( $V_O = 3.8$ or $0.5$ V) ( $V_O = 8.8$ or $1.0$ V) ( $V_O = 13.8$ or $1.5$ V)	$V_{IL}$	5	—	1.5	—	2.25	1.5	—	1.5	V	
		10	—	3.0	—	4.50	3.0	—	3.0		
		15	—	4.0	—	6.00	4.0	—	4.0		
	"1" Level ( $V_O = 0.5$ or $3.8$ V) ( $V_O = 1.0$ or $8.8$ V) ( $V_O = 1.5$ or $13.8$ V)	$V_{IH}$	5	3.5	—	3.5	2.75	—	3.5	—	V
			10	7.0	—	7.0	5.50	—	7.0	—	
			15	11.0	—	11.0	8.25	—	11.0	—	
Output Voltage: a - g, h + i $V_{in} = V_{DD}$ or 0, $I_{out} = 0$ $\mu$ A	$V_{OL}$	5	—	0.1	—	0	0.05	—	0.05	V	
		10	—	0.1	—	0	0.05	—	0.05		
		15	—	0.1	—	0	0.05	—	0.05		
Output Drive Voltage: a - g, h + i ( $I_{OH} = 0$ mA) ( $I_{OH} = 5$ mA) ( $I_{OH} = 10$ mA)	$V_{OH}$	5	4.0	—	4.0	4.8	—	4.0	—	V	
			2.45	—	2.4	3.0	—	2.05	—		
			1.3	—	0.8	1.7	—	—	—		
		10	9.0	—	9.0	9.8	—	9.0	—	V	
			7.4	—	7.2	8.0	—	6.9	—		
			6.4	—	5.8	6.7	—	5.0	—		
		15	5.3	—	4.4	5.3	—	3.05	—	V	
			14.0	—	14.0	14.8	—	14.0	—		
			12.2	—	12.0	13.0	—	11.7	—		
		(Per Package) ( $I_{OH} = 5$ mA) ( $I_{OH} = 10$ mA) ( $I_{OH} = 15$ mA) ( $I_{OH} = 20$ mA) ( $I_{OH} = 25$ mA)		10.9	—	10.4	11.7	—	9.6	—	V
				9.7	—	8.8	10.3	—	7.45	—	
				8.5	—	7.2	8.8	—	5.25	—	
Output Sink Current: j ( $V_{OL} = 0.4$ V) ( $V_{OL} = 0.5$ V) ( $V_{OL} = 1.5$ V)	$I_{OL}$	5	—	—	0.3	1.00	—	—	—	mA	
		10	—	—	—	—	—	—	—		
		15	—	—	0.5	1.25	—	—	—		
Input Current (L Device)	$I_{in}$	15	—	$\pm 0.1$	—	$\pm 0.00001$	$\pm 0.1$	—	$\pm 1.0$	$\mu$ A	
Input Current (P Device)	$I_{in}$	15	—	$\pm 0.3$	—	$\pm 0.00001$	$\pm 0.3$	—	$\pm 1.0$	$\mu$ A	
Input Capacitance	$C_{in}$	—	—	—	—	5.0	7.5	—	—	pF	
Quiescent Current $V_{in} = 0$ or $V_{DD}$ , $I_{out} = 0$ $\mu$ A (Per Package)	$I_{DD}$	5	—	0.3	—	0.08	0.25	—	0.2	mA	
		10	—	1.5	—	0.40	1.25	—	1.0		
		15	—	3.0	—	0.85	2.50	—	2.0		
Total Supply Current**†† (Dynamic plus Quiescent, Per Package) ( $C_L = 50$ pF on all outputs, all buffers switching)	$I_T$	5	$I_T = (1.9 \mu\text{A}/\text{kHz})f + I_{DD}$							$\mu$ A	
		10	$I_T = (3.8 \mu\text{A}/\text{kHz})f + I_{DD}$								
		15	$I_T = (5.7 \mu\text{A}/\text{kHz})f + I_{DD}$								

†To calculate total supply current at loads other than 50 pF:  $I_T(C_L = I_T(50 \text{ pF}) + 3.5 \times 10^{-3}(C_L - 50) V_{DD}f$   
where:  $I_T$  is in  $\mu$ A (per package),  $C_L$  in pF,  $V_{DD}$  in V, and f in kHz is input frequency.

\*\*†† The formulas given are for the typical characteristics only at 25°C.

#Data labelled "Typ" is not to be used for design purposes but is intended as an indication of the IC's potential performance.

# MC14495-1

## SWITCHING CHARACTERISTICS (C<sub>L</sub> = 50 pF, T<sub>A</sub> = 25 °C)

Characteristic	Symbol	V <sub>DD</sub> V	Min	Typ#	Max	Unit
Output Rise Time, a-g, h+i Outputs (Figure 1)	t <sub>PLH</sub>	5	—	210	450	ns
		10	—	145	300	
		15	—	90	200	
Output Fall Time, a-g, h+i Outputs (Figure 1)	t <sub>THL</sub>	5	—	1.5	3.5	μs
		10	—	1.3	2.75	
		15	—	1.1	2.25	
Output Fall Time, j Output (Figures 3 and 4)	t <sub>THL</sub>	5	—	105	250	ns
		10	—	40	100	
		15	—	30	75	
Propagation Delay Time, A, B, C, D to a-g, h+i Outputs (Figure 2)	t <sub>PLH</sub>	5	—	935	2400	ns
		10	—	340	900	
		15	—	230	500	
	t <sub>PHL</sub>	5	—	7.0	18.0	μs
		10	—	3.5	9.0	
		15	—	2.0	5.0	
Propagation Delay Time, A, B, C, D to j Output (Figures 3 and 4)	t <sub>PLZ</sub>	5	—	11.0	25.0	μs
		10	—	8.0	20.0	
		15	—	4.0	10.0	
	t <sub>PZL</sub>	5	—	800	1500	ns
		10	—	400	1000	
		15	—	200	500	
Propagation Delay Time, LE to a-g, h+i Outputs (Figure 5)	t <sub>PLH</sub>	5	—	1300	3000	ns
		10	—	500	1500	
		15	—	350	1000	
	t <sub>PHL</sub>	5	—	16.0	30.0	μs
		10	—	6.0	15.0	
		15	—	5.0	10.0	
Propagation Delay Time, LE to j Output (Figures 4 and 6)	t <sub>PLZ</sub>	5	—	14.0	30	μs
		10	—	8.0	20	
		15	—	6.0	15	
	t <sub>PZL</sub>	5	—	10.0	25	μs
		10	—	5.0	15	
		15	—	4.0	10	
Setup Time, A, B, C, D to LE (Figure 7)	t <sub>su</sub>	5	100	35	—	ns
		10	65	25	—	
		15	65	25	—	
Hold Time, LE to A, B, C, D (Figure 7)	t <sub>h</sub>	5	125	45	—	ns
		10	75	30	—	
		15	75	25	—	
Latch Enable Pulse Width, LE (Figure 7)	t <sub>w</sub>	5	525	210	—	ns
		10	200	80	—	
		15	140	55	—	

#Data labelled "Typ" is not to be used for design purposes but is intended as an indication of the IC's potential performance.

### OUTPUT CIRCUIT

(Except Pin 11)

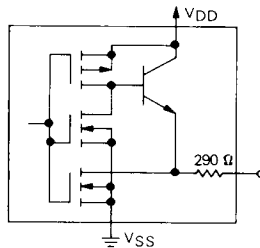

INPUT/OUTPUT FUNCTIONS

**SEGMENT DRIVER (a, b, c, d, e, f, g, h + i; PINS 12, 13, 14, 15, 1, 2, 3, 4)**

The segment drivers are emitter-follower NPN transistors. To limit the output current, a resistor, typically 290 ohms, is integrated internally at each output. Therefore, external resistors are not necessary when driving an LED at the supply voltage of  $V_{DD}=5.0$  volts.

**OUTPUT (j; PIN 11)**

This open-drain output is activated (goes low) whenever inputs A, B, C, and D are all set to a logic one. Otherwise the output is in the high-impedance state. See the truth table.

**INPUT DATA (A, B, C, D; PINS 5, 6, 9, 10)**

The inputs A, B, C, and D are fed to a 4-bit latch which is controlled by the Latch Enable input.

**LATCH ENABLE (LE; PIN 7)**

The data on inputs A, B, C and D will pass through the latch and will be decoded immediately when LE is low. In this mode of operation the circuit is performing the function of a conventional decoder/driver. The data may be loaded into the latch when LE = low and will be latched with the rising edge of LE. The data will remain stored as long as LE is high.

SWITCHING WAVEFORMS

Figure 1

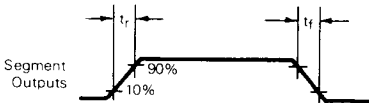

Figure 3

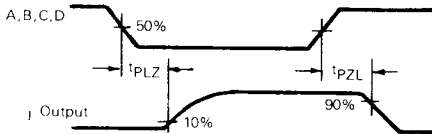

Figure 4

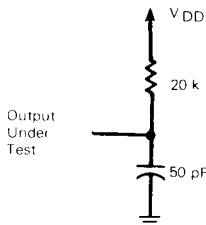

Figure 2

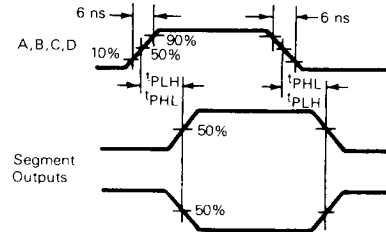
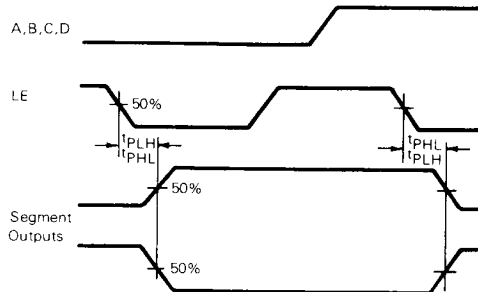

Figure 5



# MC14495-1

3

## SWITCHING WAVEFORMS

Figure 6

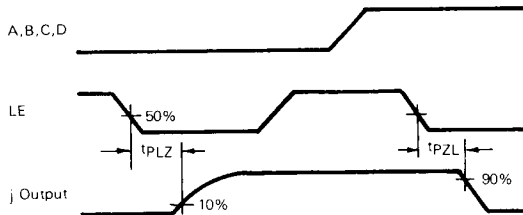
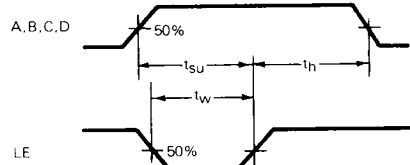

Figure 7



TYPICAL CIRCUIT @  $V_{DD} = 5.0\text{ V}$

