

LM12



T-79-23

## LM12 (L/C/CL) 150W Operational Amplifier

### General Description

The LM12 is a power op amp capable of driving  $\pm 35V$  at  $\pm 10A$  while operating from  $\pm 40V$  supplies. The monolithic IC can deliver 150W of sine wave power into a  $4\Omega$  load with 0.01% distortion. Power bandwidth is 60 kHz. Further, a peak dissipation capability of 800W allows it to handle reactive loads such as transducers, actuators or small motors without derating. Important features include:

- input protection
- controlled turn on
- thermal limiting
- overvoltage shutdown
- output-current limiting
- dynamic safe-area protection

The IC delivers  $\pm 10A$  output current at any output voltage yet is completely protected against overloads, including shorts to the supplies. The dynamic safe-area protection is provided by instantaneous peak-temperature limiting within the power transistor array.

The turn-on characteristics are controlled by keeping the output open-circuited until the total supply voltage reaches 14V. The output is also opened as the case temperature

exceeds  $150^\circ C$  or as the supply voltage approaches the  $BV_{CEO}$  of the output transistors. The IC withstands overvoltages to 100V.

This monolithic op amp is compensated for unity-gain feedback, with a small-signal bandwidth of 700 kHz. Slew rate is  $9V/\mu s$ , even as a follower. Distortion and capacitive-load stability rival that of the best designs using complementary output transistors. Further, the IC withstands large differential input voltages and is well behaved should the common-mode range be exceeded.

The LM12 establishes that monolithic ICs can deliver considerable output power without resorting to complex switching schemes. Devices can be paralleled or bridged for even greater output capability. Applications include operational power supplies, high-voltage regulators, high-quality audio amplifiers, tape-head positioners, x-y plotters or other servo-control systems.

The LM12 is supplied in a four-lead, TO-3 package with  $V^-$  on the case. A gold-eutectic die-attach to a molybdenum interface is used to avoid thermal fatigue problems. Two voltage grades are available; both are specified for either military or commercial temperature range.

### Connection Diagram

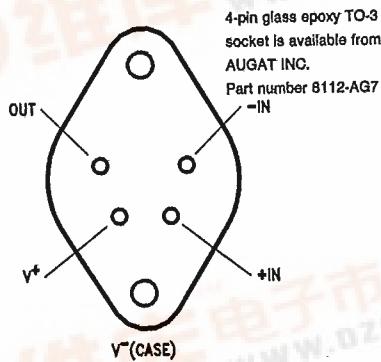

Bottom View

Order Number LM12K, LM12CK or LM12CLK  
See NS Package Number K04A

### Typical Application\*

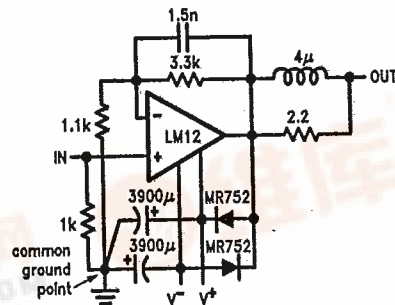

TL/H/8704-2

\*Low distortion (0.01%) audio amplifier



**Absolute Maximum Ratings**

If Military/Aerospace specified devices are required, please contact the National Semiconductor Sales Office/Distributors for availability and specifications.

Total Supply Voltage	LM12/LM12C	100V
	LM12L/LM12CL	80V
Input Voltage		Note 1
Output Current		Internally Limited

**T-79-23**

Junction Temperature	Note 2
Storage Temperature Range	-65°C to 150°C
Lead Temperature (Soldering, 10 seconds)	300°C
ESD Rating to be Determined.	

**Operating Ratings**

Total Supply Voltage	LM12/LM12C	15V to 80V
	LM12L/LM12CL	15V to 60V

**Electrical Characteristics (Note 3)**

Parameter	Conditions	Typ 25°C	LM12 LM12L	LM12C LM12CL	Units
			Limits	Limits	
Input Offset Voltage	$\pm 10V \leq V_S \leq \pm 0.5 V_{MAX}$ , $V_{CM} = 0$	2	7/15	15/20	mV (max)
Input Bias Current	$V^- + 4V \leq V_{CM} \leq V^+ - 2V$	0.15	0.3/1.0	0.7/1.0	$\mu A$ (max)
Input Offset Current	$V^- + 4V \leq V_{CM} \leq V^+ - 2V$	0.03	0.1/0.3	0.2/0.3	$\mu A$ (max)
Common Mode Rejection	$V^- + 4V \leq V_{CM} \leq V^+ - 2V$	86	75/70	70/65	dB (min)
Power Supply Rejection	$V^+ = 0.5 V_{MAX}$ , $-6V \geq V^- \geq -0.5 V_{MAX}$ , $V^- = -0.5 V_{MAX}$ , $6V \leq V^+ \leq 0.5 V_{MAX}$	90	75/70	70/65	dB (min)
		110	80/75	75/70	dB (min)
Output Saturation Threshold	$t_{ON} = 1$ ms, $\Delta V_{IN} = 5$ (10) mV, $I_{OUT} = 1A$ 8A 10A	1.8	2.2/2.5	2.2/2.5	V (max)
		4	5/7	5/7	V (max)
		5	8		V (max)
Large Signal Voltage Gain	$t_{ON} = 2$ ms, $V_{SAT} = 2V, I_{OUT} = 0$ $V_{SAT} = 8V, R_L = 4\Omega$	100	50/30	30/20	V/mV (min)
		50	20/15	15/10	V/mV (min)
Thermal Gradient Feedback	$P_{DISS} = 50W, t_{ON} = 65$ ms	30	50	100	$\mu V/W$ (max)
Output-Current Limit	$t_{ON} = 10$ ms, $V_{DISS} = 10V$ $t_{ON} = 100$ ms, $V_{DISS} = 58V$ LM12/LM12C $t_{ON} = 100$ ms, $V_{DISS} = 78V$	13	16	16	A (max)
		1.5	1.0/0.6	0.9/0.6	A (min)
		1.5	1.7	1.7	A (max)
		0.7	0.6/0.4	0.5/0.35	A (min)
Power Dissipation Rating	$t_{ON} = 100$ ms, $V_{DISS} = 20V$ $V_{DISS} = 58V$	100	90/40	80/55	W (min)
		80	58/35	52/35	W (min)
DC Thermal Resistance	(Note 4) $V_{DISS} = 20V$ $V_{DISS} = 58V$	2.3	2.6	2.9	$^{\circ}C/W$ (max)
		2.7	4.0	4.5	$^{\circ}C/W$ (max)
AC Thermal Resistance	(Note 4)	1.6	1.9	2.1	$^{\circ}C/W$ (max)
Supply Current	$V_{OUT} = 0, I_{OUT} = 0$	60	80/90	120/140	mA (max)

Note 1. Neither input should exceed the supply voltage by more than 50 volts nor should the voltage between one input and any other terminal exceed 80 volts for the LM12/LM12C or 60 volts for the LM12L/LM12CL.

Note 2. Operating junction temperature is internally limited near 225°C within the power transistor and 160°C for the control circuitry.

Note 3. The supply voltage is  $\pm 40V$  ( $V_{MAX} = 80V$ ) for the LM12/LM12C and  $\pm 30V$  ( $V_{MAX} = 60V$ ) for the LM12L/LM12CL, unless otherwise specified. The voltage across the conducting output transistor (supply to output) is  $V_{DISS}$  and internal power dissipation is  $P_{DISS}$ . Temperature range is  $-55^{\circ}C \leq T_C \leq 125^{\circ}C$  for the LM12/LM12L and  $0^{\circ}C \leq T_C \leq 70^{\circ}C$  for LM12C/LM12CL, where  $T_C$  is the case temperature. Standard typeface indicates limits at 25°C while boldface type refers to limits or special conditions over full temperature range. With no heat sink, the package will heat at a rate of 35°C/sec per 100W of internal dissipation.

Note 4. This thermal resistance is based upon a peak temperature of 200°C in the center of the power transistor and a case temperature of 25°C measured at the center of the package bottom. The maximum junction temperature of the control circuitry can be estimated based upon a dc thermal resistance of 0.9°C/W or an ac thermal resistance of 0.8°C/W for any operating voltage.

Although the output and supply leads are resistant to electrostatic discharges from handling, the input leads are not. The part should be treated accordingly.



LM12

T-79-23

Output-Transistor Ratings (guaranteed)†

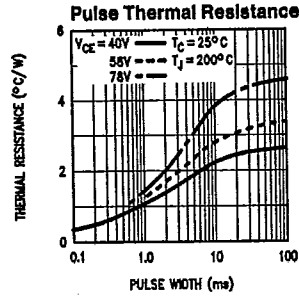
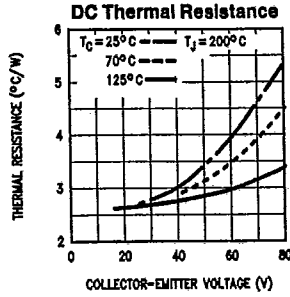
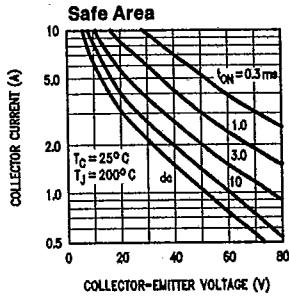

TL/H/8704-3

†LM12/LM12L. The power ratings of the LM12C/LM12CL are 10-percent less at 20V and 15-percent less at 60V, with a corresponding increase in thermal resistance and decrease in safe area current.

Typical Performance Characteristics

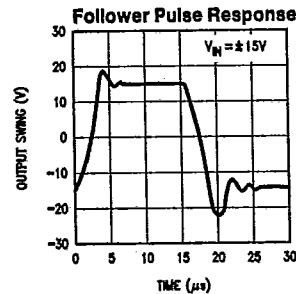
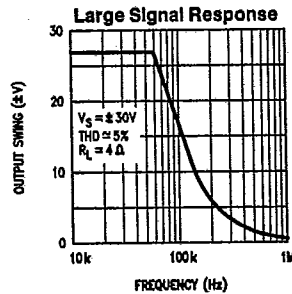
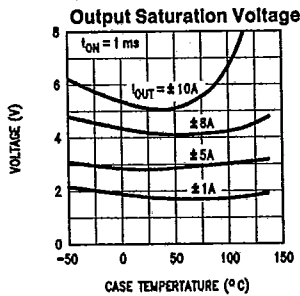
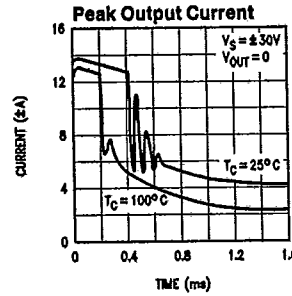
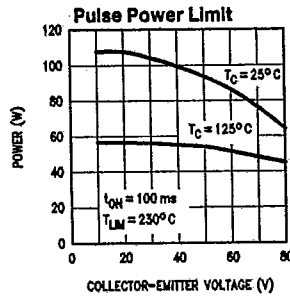
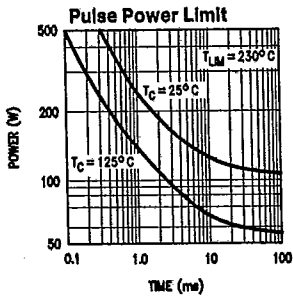

TL/H/8704-4

Typical Performance Characteristics (Continued)

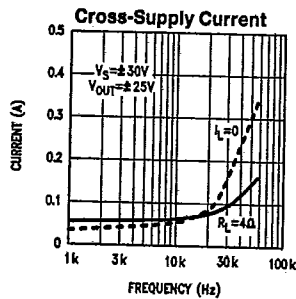
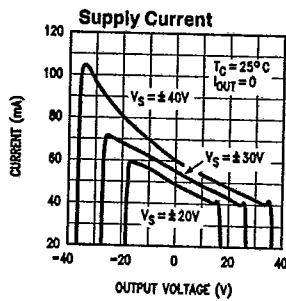
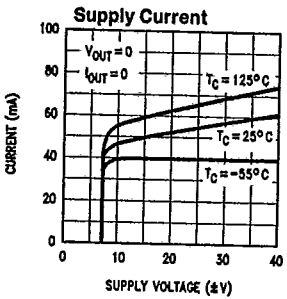
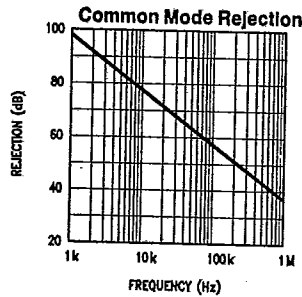
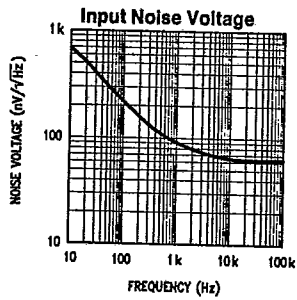
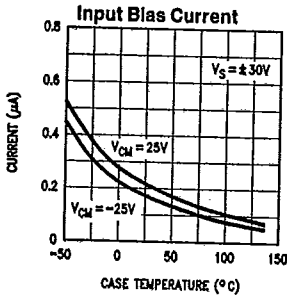
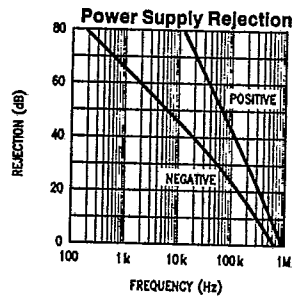
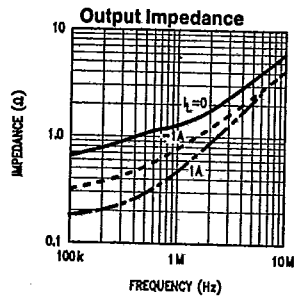
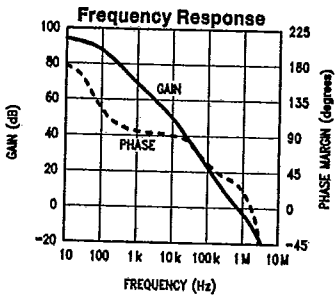
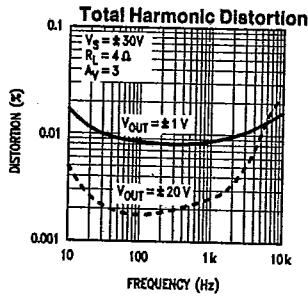
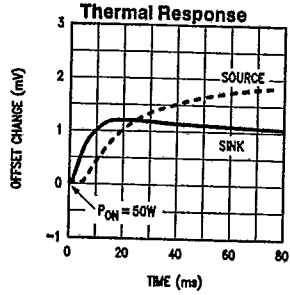
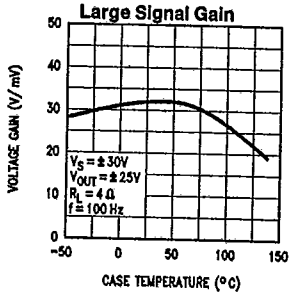

TL/H/8704-5



## Application Information

T-79-23

### GENERAL

Twenty five years ago the operational amplifier was a specialized design tool used primarily for analog computation. However, the availability of low cost IC op amps in the late 1960's prompted their use in rather mundane applications, replacing a few discrete components. Once a few basic principles are mastered, op amps can be used to give exceptionally good results in a wide range of applications while minimizing both cost and design effort.

The availability of a monolithic power op amp now promises to extend these advantages to high-power designs. Some conventional applications are given here to illustrate op amp design principles as they relate to power circuitry. The inevitable fall in prices, as the economies of volume production are realized, will prompt their use in applications that might now seem trivial. Replacing single power transistors with an op amp will become economical because of improved performance, simplification of attendant circuitry, vastly improved fault protection, greater reliability and the reduction of design time.

Power op amps introduce new factors into the design equation. With current transients above 10A, both the inductance and resistance of wire interconnects become important in a number of ways. Further, power ratings are a crucial factor in determining performance. But the power capability of the IC cannot be realized unless it is properly mounted to an adequate heat sink. Thus, thermal design is of major importance with power op amps.

This application summary starts off by identifying the origin of strange problems observed while using the LM12 in a wide variety of designs with all sorts of fault conditions. A few simple precautions will eliminate these problems. **One would do well to read the section on supply bypassing, lead inductance, output clamp diodes, ground loops and reactive loading before doing any experimentation. Should there be problems with erratic operation, blow-outs, excessive distortion or oscillation, another look at these sections is in order.**

The management and protection circuitry can also affect operation. Should the total supply voltage exceed ratings or drop below 15-20V, the op amp shuts off completely. Case temperatures above 150°C also cause shut down until the temperature drops to 145°C. This may take several seconds, depending on the thermal system. Activation of the dynamic safe-area protection causes both the main feedback loop to lose control and a reduction in output power, with possible oscillations. In ac applications, the dynamic protection will cause waveform distortion. Since the LM12 is well protected against thermal overloads, the suggestions for determining power dissipation and heat sink requirements are presented last.

### SUPPLY BYPASSING

All op amps should have their supply leads bypassed with low-inductance capacitors having short leads and located close to the package terminals to avoid spurious oscillation problems. Power op amps require larger bypass capacitors. The LM12 is stable with good-quality electrolytic bypass capacitors greater than 20  $\mu$ F. Other considerations may require larger capacitors.

The current in the supply leads is a rectified component of the load current. If adequate bypassing is not provided, this distorted signal can be fed back into internal circuitry. Low distortion at high frequencies requires that the supplies be bypassed with 470  $\mu$ F or more, at the package terminals.

### LEAD INDUCTANCE

With ordinary op amps, lead-inductance problems are usually restricted to supply bypassing. Power op amps are also sensitive to inductance in the output lead, particularly with heavy capacitive loading. Feedback to the input should be taken directly from the output terminal, minimizing common inductance with the load. Sensing to a remote load must be accompanied by a high-frequency feedback path directly from the output terminal. Lead inductance can also cause voltage surges on the supplies. With long leads to the power source, energy stored in the lead inductance when the output is shorted can be dumped back into the supply bypass capacitors when the short is removed. The magnitude of this transient is reduced by increasing the size of the bypass capacitor near the IC. With 20  $\mu$ F local bypass, these voltage surges are important only if the lead length exceeds a couple feet ( $> 1 \mu$ H lead inductance). Twisting together the supply and ground leads minimizes the effect.

### GROUND LOOPS

With fast, high-current circuitry, all sorts of problems can arise from improper grounding. In general, difficulties can be avoided by returning all grounds separately to a common point. Sometimes this is impractical. When compromising, special attention should be paid to the ground returns for the supply bypasses, load and input signal. Ground planes also help to provide proper grounding.

Many problems unrelated to system performance can be traced to the grounding of line-operated test equipment used for system checkout. Hidden paths are particularly difficult to sort out when several pieces of test equipment are used but can be minimized by using current probes or the new isolated oscilloscope pre-amplifiers. Eliminating any direct ground connection between the signal generator and the oscilloscope synchronization input solves one common problem.

### OUTPUT CLAMP DIODES

When a push-pull amplifier goes into power limit while driving an inductive load, the stored energy in the load inductance can drive the output outside the supplies. Although the LM12 has internal clamp diodes that can handle several amperes for a few milliseconds, extreme conditions can cause destruction of the IC. The internal clamp diodes are imperfect in that about half the clamp current flows into the supply to which the output is clamped while the other half flows across the supplies. Therefore, the use of external diodes to clamp the output to the power supplies is strongly recommended. This is particularly important with higher supply voltages.

Experience has demonstrated that hard-wire shorting the output to the supplies can induce random failures if these external clamp diodes are not used and the supply voltages are above  $\pm 20$ V. Therefore it is prudent to use output-

T-79-23

LM12

**Application Information (Continued)**

clamp diodes even when the load is not particularly inductive. This also applies to experimental setups in that blow-outs have been observed when diodes were not used. In packaged equipment, it may be possible to eliminate these diodes, providing that fault conditions can be controlled.

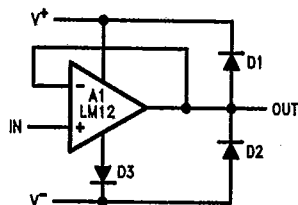

TL/H/8704-6

Heat sinking of the clamp diodes is usually unimportant in that they only clamp current transients. Forward drop with 15A fault transients is of greater concern. Usually, these transients die out rapidly. The clamp to the negative supply can have somewhat reduced effectiveness under worst case conditions should the forward drop exceed 1.0V. Mounting this diode to the power op amp heat sink improves the situation. Although the need has only been demonstrated with some motor loads, including a third diode (D3 above) will eliminate any concern about the clamp diodes. This diode, however, must be capable of dissipating continuous power as determined by the negative supply current of the op amp.

**REACTIVE LOADING**

The LM12 is normally stable with resistive, inductive or smaller capacitive loads. Larger capacitive loads interact with the open-loop output resistance (about  $1\Omega$ ) to reduce the phase margin of the feedback loop, ultimately causing oscillation. The critical capacitance depends upon the feedback applied around the amplifier; a unity-gain follower can handle about  $0.01\mu\text{F}$ , while more than  $1\mu\text{F}$  does not cause problems if the loop gain is ten. With loop gains greater than unity, a speedup capacitor across the feedback resistor will aid stability. In all cases, the op amp will behave predictably only if the supplies are properly bypassed, ground loops are controlled and high-frequency feedback is derived directly from the output terminal, as recommended earlier.

So-called capacitive loads are not always capacitive. A high-Q capacitor in combination with long leads can present a series-resonant load to the op amp. In practice, this is not usually a problem; but the situation should be kept in mind.

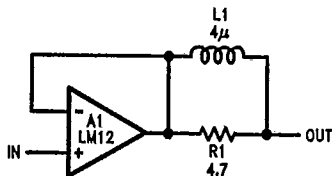

TL/H/8704-7

Large capacitive loads (including series-resonant) can be accommodated by isolating the feedback amplifier from the load as shown above. The inductor gives low output impedance at lower frequencies while providing an isolating impedance at high frequencies. The resistor kills the Q of series resonant circuits formed by capacitive loads. A low inductance, carbon-composition resistor is recommended. Optimum values of L and R depend upon the feedback gain

and expected nature of the load, but are not critical. A  $4\mu\text{H}$  inductor is obtained with 14 turns of number 18 wire, close spaced, around a one-inch-diameter form.

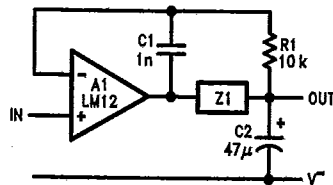

TL/H/8704-8

The LM12 can be made stable for all loads with a large capacitor on the output, as shown above. This compensation gives the lowest possible closed-loop output impedance at high frequencies and the best load-transient response. It is appropriate for such applications as voltage regulators.

A feedback capacitor,  $C_1$ , is connected directly to the output pin of the IC. The output capacitor,  $C_2$ , is connected at the output terminal with short leads. Single-point grounding to avoid dc and ac ground loops is advised.

The impedance,  $Z_1$ , is the wire connecting the op amp output to the load capacitor. About 3-inches of number-18 wire (70 nH) gives good stability and 18-inches (400 nH) begins to degrade load-transient response. The minimum load capacitance is  $47\mu\text{F}$ , if a solid-tantalum capacitor with an equivalent series resistance (ESR) of  $0.1\Omega$  is used. Electrolytic capacitors work as well, although capacitance may have to be increased to  $200\mu\text{F}$  to bring ESR below  $0.1\Omega$ .

Loop stability is not the only concern when op amps are operated with reactive loads. With time-varying signals, power dissipation can also increase markedly. This is particularly true with the combination of capacitive loads and high-frequency excitation.

**INPUT COMPENSATION**

The LM12 is prone to low-amplitude oscillation bursts coming out of saturation if the high-frequency loop gain is near unity. The voltage follower connection is most susceptible. This glitching can be eliminated at the expense of small-signal bandwidth using input compensation. Input compensation can also be used in combination with LR load isolation to improve capacitive load stability.

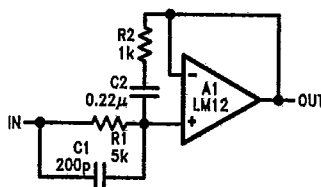

TL/H/8704-9

An example of a voltage follower with input compensation is shown here. The  $R_2C_2$  combination across the input works with  $R_1$  to reduce feedback at high frequencies without greatly affecting response below 100 kHz. A lead capacitor,  $C_1$ , improves phase margin at the unity-gain crossover frequency. Proper operation requires that the output impedance of the circuitry driving the follower be well under  $1\text{k}\Omega$  at frequencies up to a few hundred kilohertz.

3

LM12

Application Information (Continued)

T-79-23

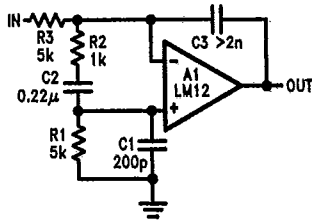

TL/H/8704-10

Extending input compensation to the integrator connection is shown here. Both the follower and this integrator will handle 1  $\mu$ F capacitive loading without LR output isolation.

CURRENT DRIVE

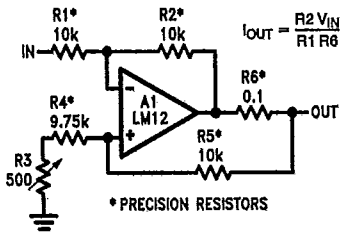

TL/H/8704-11

This circuit provides an output current proportional to the input voltage. Current drive is sometimes preferred for servo motors because it aids in stabilizing the servo loop by reducing phase lag caused by motor inductance. In applications requiring high output resistance, such as operational power supplies running in the current mode, matching of the feedback resistors to 0.01% is required. Alternately, an adjustable resistor can be used for trimming.

PARALLEL OPERATION

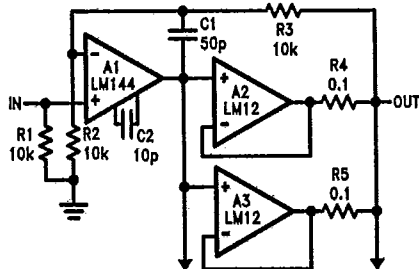

TL/H/8704-12

Output drive beyond the capability of one power amplifier can be provided as shown here. The power op amps are wired as followers and connected in parallel with the outputs coupled through equalization resistors. A standard, high-voltage op amp is used to provide voltage gain. Overall feedback compensates for the voltage dropped across the equalization resistors.

With parallel operation, there may be an increase in unloaded supply current related to the offset voltage across the

equalization resistors. More output buffers, with individual equalization resistors, may be added to meet even higher drive requirements.

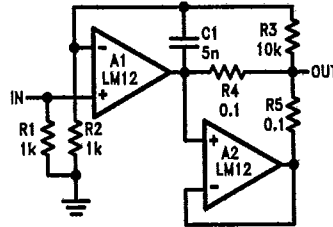

TL/H/8704-13

This connection allows increased output capability without requiring a separate control amplifier. The output buffer, A<sub>2</sub>, provides load current through R<sub>5</sub> equal to that supplied by the main amplifier, A<sub>1</sub>, through R<sub>4</sub>. Again, more output buffers can be added.

Current sharing among paralleled amplifiers can be affected by gain error as the power-bandwidth limit is approached. In the first circuit, the operating current increase will depend upon the matching of high-frequency characteristics. In the second circuit, however, the entire input error of A<sub>2</sub> appears across R<sub>4</sub> and R<sub>5</sub>. The supply current increase can cause power limiting to be activated as the slew limit is approached. This will not damage the LM12. It can be avoided in both cases by connecting A<sub>1</sub> as an inverting amplifier and restricting bandwidth with C<sub>1</sub>.

SINGLE-SUPPLY OPERATION

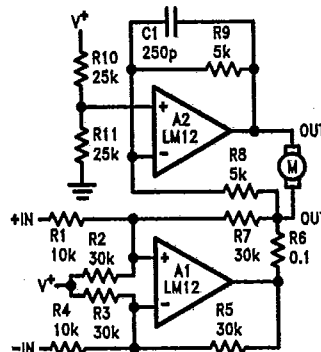

TL/H/8704-14

Although op amps are usually operated from dual supplies, single-supply operation is practical. This bridge amplifier supplies bi-directional current drive to a servo motor while operating from a single positive supply. The output is easily converted to voltage drive by shorting R<sub>8</sub> and connecting R<sub>7</sub> to the output of A<sub>2</sub>, rather than A<sub>1</sub>.

Either input may be grounded, with bi-directional drive provided to the other. It is also possible to connect one input to a positive reference, with the input signal varying about this voltage. If the reference voltage is above 5V, R<sub>2</sub> and R<sub>3</sub> are not required.

**Application Information** (Continued)

T-79-23

**HIGH VOLTAGE AMPLIFIERS**

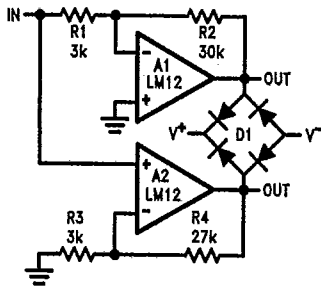

TL/H/8704-15

The voltage swing delivered to the load can be doubled by using the bridge connection shown here. Output clamping to the supplies can be provided by using a bridge-rectifier assembly.

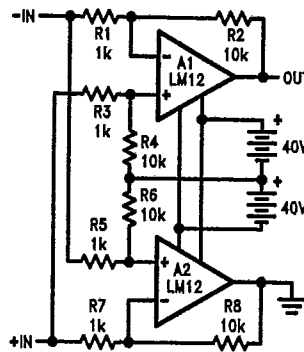

TL/H/8704-16

One limitation of the standard bridge connection is that the load cannot be returned to ground. This can be circumvented by operating the bridge with floating supplies, as shown above. For single-ended drive, either input can be grounded.

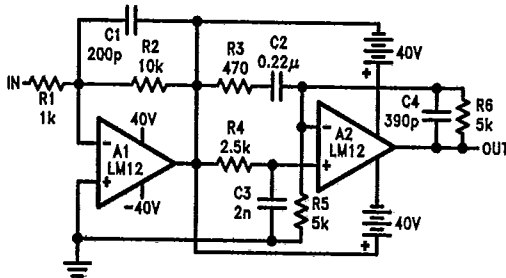

TL/H/8704-17

This circuit shows how two amplifiers can be cascaded to double output swing. The advantage over the bridge is that the output can be increased with any number of stages, although separate supplies are required for each.

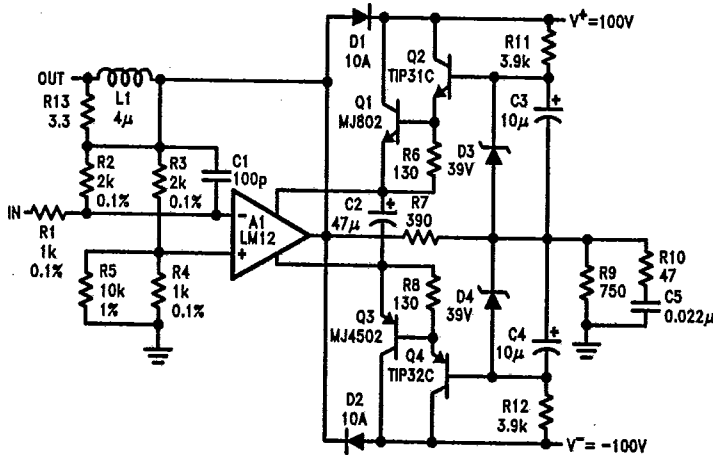

TL/H/8704-18

Discrete transistors can be used to increase output drive to  $\pm 90V$  at  $\pm 10A$  as shown above. With proper thermal design, the IC will provide safe-area protection for the external transistors. Voltage gain is about thirty.



Application Information (Continued)

T-79-23

OPERATIONAL POWER SUPPLY

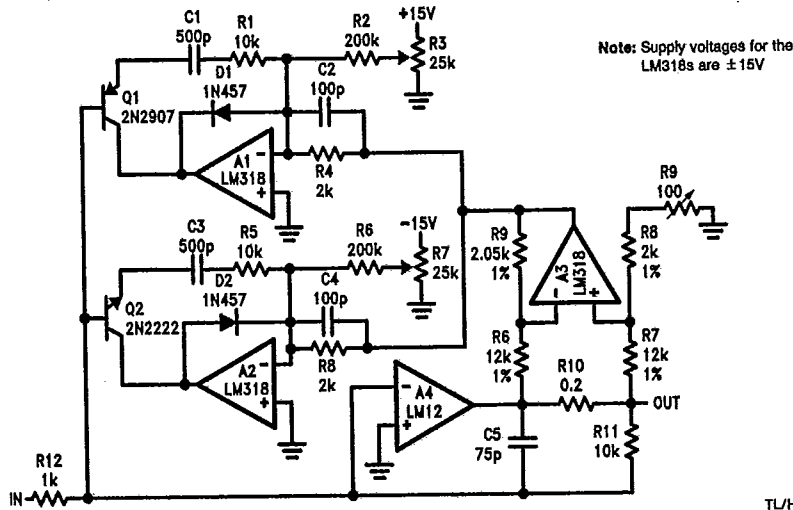

TL/H/8704-19

External current limit can be provided for a power op amp as shown above. The positive and negative current limits can be set precisely and independently. Fast response is assured by D<sub>1</sub> and D<sub>2</sub>. Adjustment range can be set down to zero with potentiometers R<sub>3</sub> and R<sub>7</sub>. Alternately, the limit can be programmed from a voltage supplied to R<sub>2</sub> and R<sub>6</sub>. This is the set up required for an operational power supply or voltage-programmable power source.

SERVO AMPLIFIERS

When making servo systems with a power op amp, there is a temptation to use it for frequency shaping to stabilize the servo loop. Sometimes this works; other times there are better ways; and occasionally it just doesn't fly. Usually it's a matter of how quickly and to what accuracy the servo must stabilize.

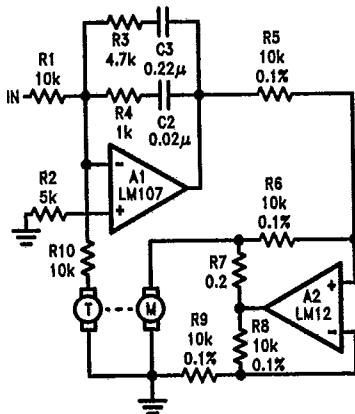

TL/H/8704-20

This motor/tachometer servo gives an output speed proportional to input voltage. A low-level op amp is used for frequency shaping while the power op amp provides current drive to the motor. Current drive eliminates loop phase shift due to motor inductance and makes high-performance servos easier to stabilize.

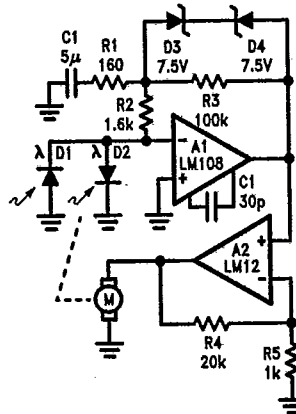

TL/H/8704-21

This position servo uses an op amp to develop the rate signal electrically instead of using a tachometer. In high-performance servos, rate signals must be developed with large error signals well beyond saturation of the motor drive. Using a separate op amp with a feedback clamp allows the rate signal to be developed properly with position errors more than an order of magnitude beyond the loop-saturation level as long as the photodiode sensors are positioned with this in mind.

**Application Information** (Continued)

**VOLTAGE REGULATORS**

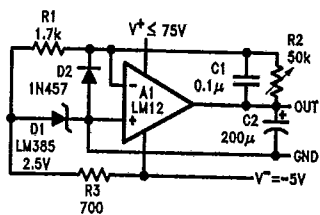

TL/H/8704-22

An op amp can be used as a positive or negative regulator. Unlike most regulators, it can sink current to absorb energy dumped back into the output. This positive regulator has a 0-70V output range.

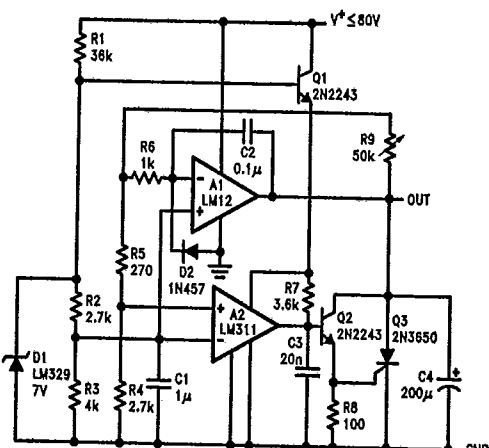

TL/H/8704-23

Dual supplies are not required to use an op amp as a voltage regulator if zero output is not required. This 4V to 70V regulator operates from a single supply. Should the op amp not be able to absorb enough energy to control an overvoltage condition, a SCR will crowbar the output.

**T-79-23**

**REMOTE SENSING**

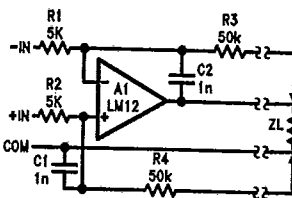

TL/H/8704-24

Remote sensing as shown above allows the op amp to correct for dc drops in cables connecting the load. Even so, cable drop will affect transient response. Degradation can be minimized by using twisted, heavy-gauge wires on the output line. Normally, common and one input are connected together at the sending end.

**AUDIO AMPLIFIERS**

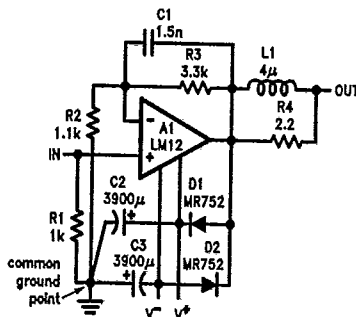

TL/H/8704-25

A power amplifier suitable for use in high-quality audio equipment is shown above. Harmonic distortion is about 0.01-percent. Intermodulation distortion (60 Hz/7 kHz, 4:1) measured 0.015-percent. Transient response and saturation recovery are clean, and the 9 V/μs slew rate of the LM12 virtually eliminates transient intermodulation distortion. Using separate amplifiers to drive low- and high-frequency speakers gets rid of high-level crossover networks and attenuators. Further, it prevents clipping on the low-frequency channel from distorting the high frequencies.

## Application Information (Continued)

### DETERMINING MAXIMUM DISSIPATION

It is a simple matter to establish power requirements for an op amp driving a resistive load at frequencies well below 10 Hz. Maximum dissipation occurs when the output is at one-half the supply voltage with high-line conditions. The individual output transistors must be rated to handle this power continuously at the maximum expected case temperature. The power rating is limited by the maximum junction temperature as determined by

$$T_J = T_C + P_{DISS} \theta_{JC}$$

where  $T_C$  is the case temperature as measured at the center of the package bottom,  $P_{DISS}$  is the maximum power dissipation and  $\theta_{JC}$  is the thermal resistance at the operating voltage of the output transistor. Recommended maximum junction temperatures are 200°C within the power transistor and 150°C for the control circuitry.

If there is ripple on the supply bus, it is valid to use the average value in worst-case calculations as long as the peak rating of the power transistor is not exceeded at the ripple peak. With 120 Hz ripple, this is 1.5 times the continuous power rating.

Dissipation requirements are not so easily established with time varying output signals, especially with reactive loads. Both peak and continuous dissipation ratings must be taken into account, and these depend on the signal waveform as well as load characteristics.

With a sine wave output, analysis is fairly straightforward. With supply voltages of  $\pm V_S$ , the maximum average power dissipation of both output transistors is

$$P_{MAX} = \frac{2V_S^2}{\pi^2 Z_L \cos \theta}, \quad \theta < 40^\circ;$$

and

$$P_{MAX} = \frac{V_S^2}{2Z_L} \left[ \frac{4}{\pi} - \cos \theta \right], \quad \theta \geq 40^\circ,$$

where  $Z_L$  is the magnitude of the load impedance and  $\theta$  its phase angle. Maximum average dissipation occurs below maximum output swing for  $\theta < 40^\circ$ .

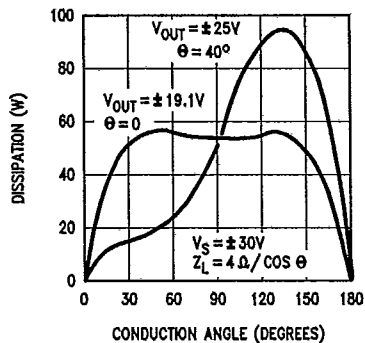

TL/H/8704-26

The instantaneous power dissipation over the conducting half cycle of one output transistor is shown here. Power dissipation is near zero on the other half cycle. The output level is that resulting in maximum peak and average dissipation. Plots are given for a resistive and a series RL load. The latter is representative of a 4Ω loudspeaker operating below resonance and would be the worst case condition in most

audio applications. The peak dissipation of each transistor is about four times average. In ac applications, power capability is often limited by the peak ratings of the power transistor.

The pulse thermal resistance of the LM12 is specified for constant power pulse duration. Establishing an exact equivalency between constant-power pulses and those encountered in practice is not easy. However, for sine waves, reasonable estimates can be made at any frequency by assuming a constant power pulse amplitude given by:

$$P_{PK} \approx \frac{V_S^2}{2Z_L} \left[ 1 - \cos(\phi - \theta) \right],$$

where  $\phi = 60^\circ$  and  $\theta$  is the absolute value of the phase angle of  $Z_L$ . Equivalent pulse width is  $t_{ON} \approx 0.4\tau$  for  $\theta = 0$  and  $t_{ON} \approx 0.2\tau$  for  $\theta \geq 20^\circ$ , where  $\tau$  is the period of the output waveform.

### DISSIPATION DRIVING MOTORS

A motor with a locked rotor looks like an inductance in series with a resistance, for purposes of determining driver dissipation. With slow-response servos, the maximum signal amplitude at frequencies where motor inductance is significant can be so small that motor inductance does not have to be taken into account. If this is the case, the motor can be treated as a simple, resistive load as long as the rotor speed is low enough that the back emf is small by comparison to the supply voltage of the driver transistor.

A permanent-magnet motor can build up a back emf that is equal to the output swing of the op amp driving it. Reversing this motor from full speed requires the output drive transistor to operate, initially, along a loadline based upon the motor resistance and total supply voltage. Worst case, this loadline will have to be within the continuous dissipation rating of the drive transistor; but system dynamics may permit taking advantage of the higher pulse ratings. Motor inductance can cause added stress if system response is fast.

Shunt- and series-wound motors can generate back emf's that are considerably more than the total supply voltage, resulting in even higher peak dissipation than a permanent-magnet motor having the same locked-rotor resistance.

### VOLTAGE REGULATOR DISSIPATION

The pass transistor dissipation of a voltage regulator is easily determined in the operating mode. Maximum continuous dissipation occurs with high line voltage and maximum load current. As discussed earlier, ripple voltage can be averaged if peak ratings are not exceeded; however, a higher average voltage will be required to insure that the pass transistor does not saturate at the ripple minimum.

Conditions during start-up can be more complex. If the input voltage increases slowly such that the regulator does not go into current limit charging output capacitance, there are no problems. If not, load capacitance and load characteristics must be taken into account. This is also the case if automatic restart is required in recovering from overloads.

Automatic restart or start-up with fast-rising input voltages cannot be guaranteed unless the continuous dissipation rating of the pass transistor is adequate to supply the load current continuously at all voltages below the regulated output voltage. In this regard, the LM12 performs much better than IC regulators using foldback current limit, especially with high-line input voltage above 20V.

**Application Information** (Continued)

**POWER LIMITING**

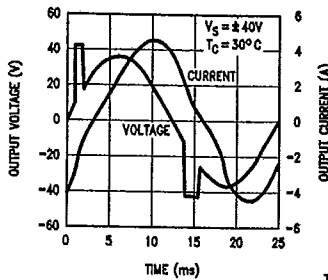

TL/H/8704-27

Should the power ratings of the LM12 be exceeded, dynamic safe-area protection is activated. Waveforms with this power limiting are shown for the LM12 driving  $\pm 36V$  at 40 Hz into  $4\Omega$  in series with 24 mH ( $\theta = 45^\circ$ ). With an inductive load, the output clamps to the supplies in power limit, as above. With resistive loads, the output voltage drops in limit. Behavior with more complex RCL loads is between these extremes.

Secondary thermal limit is activated should the case temperature exceed  $150^\circ C$ . This thermal limit shuts down the IC completely (open output) until the case temperature drops to about  $145^\circ C$ . Recovery may take several seconds.

**POWER SUPPLIES**

Power op amps do not require regulated supplies. However, the worst-case output power is determined by the low-line supply voltage in the ripple trough. The worst-case power dissipation is established by the average supply voltage with high-line conditions. The loss in power output that can be guaranteed is the square of the ratio of these two voltages.

Relatively simple off-line switching power supplies can provide voltage conversion, line isolation and 5-percent regulation while reducing size and weight.

The regulation against ripple and line variations can provide a substantial increase in the power output that can be guaranteed under worst-case conditions. In addition, switching power supplies can convert low-voltage power sources such as automotive batteries up to regulated, dual, high-voltage supplies optimized for powering power op amps.

**HEAT SINKING**

A semiconductor manufacturer has no control over heat sink design. Temperature rating can only be based upon

case temperature as measured at the center of the package bottom. With power pulses of longer duration than 100 ms, case temperature is almost entirely dependent on heat sink design and the mounting of the IC to the heat sink.

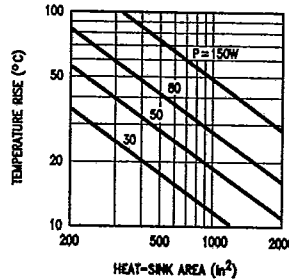

TL/H/8704-28

The design of heat sink is beyond the scope of this work. Convection-cooled heat sinks are available commercially, and their manufacturers should be consulted for ratings. The preceding figure is a rough guide for temperature rise as a function of fin area (both sides) available for convection cooling.

Proper mounting of the IC is required to minimize the thermal drop between the package and the heat sink. The heat sink must also have enough metal under the package to conduct heat from the center of the package bottom to the fins without excessive temperature drop.

A thermal grease such as Wakefield type 120 or Thermalloy Thermacote should be used when mounting the package to the heat sink. Without this compound, thermal resistance will be no better than  $0.5^\circ C/W$ , and probably much worse. With the compound, thermal resistance will be  $0.2^\circ C/W$  or less, assuming under 0.005 inch combined flatness runout for the package and heat sink. Proper torquing of the mounting bolts is important. Four to six inch-pounds is recommended.

Should it be necessary to isolate  $V^-$  from the heat sink, an insulating washer is required. Hard washers like beryllium oxide, anodized aluminum and mica require the use of thermal compound on both faces. Two-mil mica washers are most common, giving about  $0.4^\circ C/W$  interface resistance with the compound. Silicone-rubber washers are also available. A  $0.5^\circ C/W$  thermal resistance is claimed without thermal compound. Experience has shown that these rubber washers deteriorate and must be replaced should the IC be dismounted.

LM12

**Definition of Terms**

**Input offset voltage:** The absolute value of the voltage between the input terminals with the output voltage and current at zero.

**Input bias current:** The absolute value of the average of the two input currents with the output voltage and current at zero.

**Input offset current:** The absolute value of the difference in the two input currents with the output voltage and current at zero.

**Common-mode rejection:** The ratio of the input voltage range to the change in offset voltage between the extremes.

**Supply-voltage rejection:** The ratio of the specified supply-voltage change to the change in offset voltage between the extremes.

**Output saturation threshold:** The output swing limit for a specified input drive beyond that required for zero output. It is measured with respect to the supply to which the output is swinging.

**Large signal voltage gain:** The ratio of the output voltage swing to the differential input voltage required to drive the output from zero to either swing limit. The output swing limit is the supply voltage less a specified quasi-saturation voltage. A pulse of short enough duration to minimize thermal effects is used as a measurement signal.

**Thermal gradient feedback:** The input offset voltage change caused by thermal gradients generated by heating of the output transistors, but not the package. This effect is delayed by several milliseconds and results in increased gain error below 100 Hz.

**Output-current limit:** The output current with a fixed output voltage and a large input overdrive. The limiting current drops with time once the protection circuitry is activated.

**Power dissipation rating:** The power that can be dissipated for a specified time interval without activating the protection circuitry. For time intervals in excess of 100 ms, dissipation capability is determined by heat sinking of the IC package rather than by the IC itself.

**Thermal resistance:** The peak, junction-temperature rise, per unit of internal power dissipation, above the case temperature as measured at the center of the package bottom. The dc thermal resistance applies when one output transistor is operating continuously. The ac thermal resistance applies with the output transistors conducting alternately at a high enough frequency that the peak capability of neither transistor is exceeded.

**Supply current:** The current required from the power source to operate the amplifier with the output voltage and current at zero.

**Equivalent Schematic (excluding active protection circuitry)**

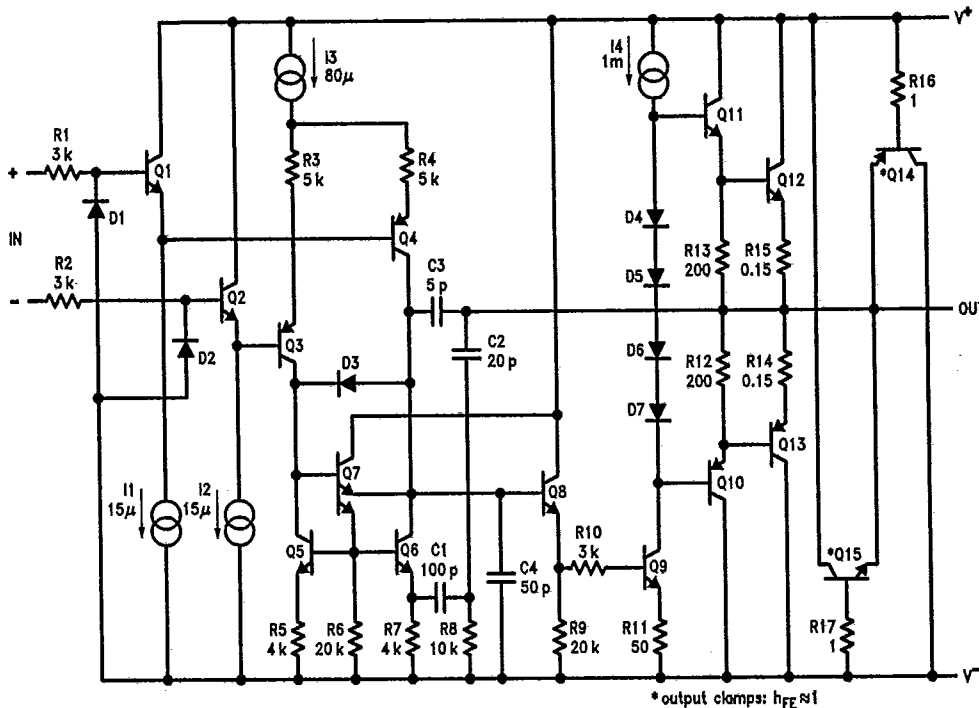

TL/H/8704-28