



# TS4890

## RAIL TO RAIL OUTPUT 1W AUDIO POWER AMPLIFIER WITH STANDBY MODE

- OPERATING FROM  $V_{CC} = 2.2V$  to  $5.5V$
- **1W** RAIL TO RAIL OUTPUT POWER @  $V_{CC}=5V$ , THD=1%,  $f=1kHz$ , with  $8\Omega$  Load
- **ULTRA LOW CONSUMPTION** IN STANDBY MODE (**10nA**)
- **75dB** PSRR @ 217Hz from 5 to 2.2V
- POP & CLICK REDUCTION CIRCUITRY
- **ULTRA LOW DISTORTION (0.1%)**
- **UNITY GAIN** STABLE
- AVAILABLE IN **MiniSO8 & SO8**

### DESCRIPTION

The TS4890 (MiniSO8 & SO8) is an Audio Power Amplifier capable of delivering 1W of continuous RMS. output power into  $8\Omega$  load @ 5V.

This Audio Amplifier is exhibiting 0.1% distortion level (THD) from a 5V supply for a  $P_{out} = 250mW$  RMS. An external standby mode control reduces the supply current to less than 10nA. An internal thermal shutdown protection is also provided.

The TS4890 have been designed for high quality audio applications such as mobile phones and to minimize the number of external components.

The unity-gain stable amplifier can be configured by external gain setting resistors.

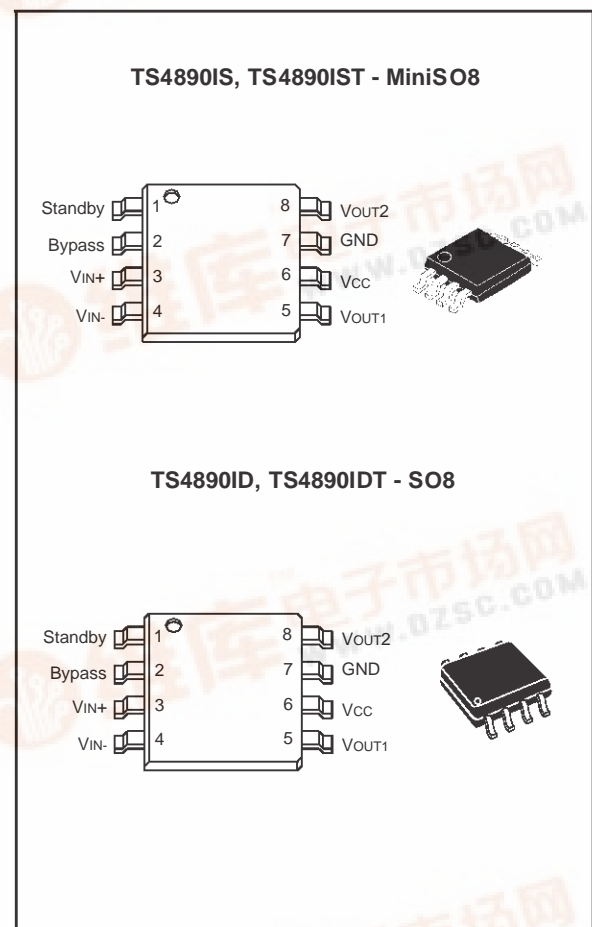
### APPLICATIONS

- Mobile Phones (Cellular / Cordless)
- Laptop / Notebook Computers
- PDAs
- Portable Audio Devices

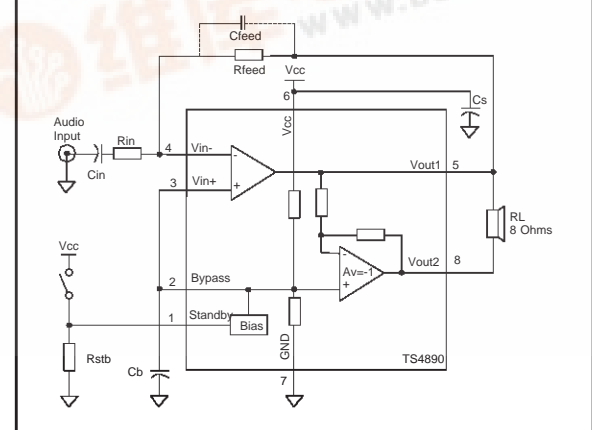
### ORDER CODE

Part Number	Temperature Range	Package	
		S	D
TS4890IST	-40, +85°C	•	
TS4890IDT			•

### PIN CONNECTIONS (Top View)



### TYPICAL APPLICATION SCHEMATIC



## TS4890

### ABSOLUTE MAXIMUM RATINGS

Symbol	Parameter	Value	Unit
$V_{CC}$	Supply voltage <sup>1)</sup>	6	V
$V_i$	Input Voltage <sup>2)</sup>	$G_{ND}$ to $V_{CC}$	V
$T_{oper}$	Operating Free Air Temperature Range	-40 to + 85	°C
$T_{stg}$	Storage Temperature	-65 to +150	°C
$T_j$	Maximum Junction Temperature	150	°C
$R_{thja}$	Thermal Resistance Junction to Ambient <sup>3)</sup> SO8 MiniSO8	175 215	°C/W
$P_d$	Power Dissipation <sup>4)</sup>	See Power Derating Curves Fig. 24	W
ESD	Human Body Model	2	kV
ESD	Machine Model	200	V
	Latch-up Immunity	Class A	
	Lead Temperature (soldering, 10sec)	260	°C

1. All voltages values are measured with respect to the ground pin.

2. The magnitude of input signal must never exceed  $V_{CC} + 0.3V$  /  $G_{ND} - 0.3V$

3. Device is protected in case of over temperature by a thermal shutdown active @ 150°C.

4. Exceeding the power derating curves during a long period may involve abnormal working of the device.

### OPERATING CONDITIONS

Symbol	Parameter	Value	Unit
$V_{CC}$	Supply Voltage	2.2 to 5.5	V
$V_{ICM}$	Common Mode Input Voltage Range	$G_{ND} + 1V$ to $V_{CC}$	V
$V_{STB}$	Standby Voltage Input : Device ON Device OFF	$1.5 \leq V_{STB} \leq V_{CC}$ $G_{ND} \leq V_{STB} \leq 0.5$	V
$R_L$	Load Resistor	4 - 32	$\Omega$
$R_{thja}$	Thermal Resistance Junction to Ambient <sup>1)</sup> SO8 MiniSO8	150 190	°C/W

1. This thermal resistance can be reduced with a suitable PCB layout (see Power Derating Curves Fig. 24)

**ELECTRICAL CHARACTERISTICS**

$V_{CC} = +5V$ ,  $GND = 0V$ ,  $T_{amb} = 25^{\circ}C$  (unless otherwise specified)

Symbol	Parameter	Min.	Typ.	Max.	Unit
$I_{CC}$	Supply Current No input signal, no load		6	8	mA
$I_{STANDBY}$	Standby Current <sup>1)</sup> No input signal, $V_{stdby} = G_{ND}$ , $R_L = 8\Omega$		10	1000	nA
$V_{OO}$	Output Offset Voltage No input signal, $R_L = 8\Omega$		5	20	mV
$P_o$	Output Power THD = 1% Max, $f = 1kHz$ , $R_L = 8\Omega$		1		W
THD + N	Total Harmonic Distortion + Noise $P_o = 250mW$ rms, $G_v = 2$ , $20Hz < f < 20kHz$ , $R_L = 8\Omega$		0.15		%
PSRR	Power Supply Rejection Ratio <sup>2)</sup> $f = 217Hz$ , $R_L = 8\Omega$ , $R_{Feed} = 22K\Omega$ , $V_{ripple} = 200mV$ rms		77		dB
$\Phi_M$	Phase Margin at Unity Gain $R_L = 8\Omega$ , $C_L = 500pF$		70		Degrees
GM	Gain Margin $R_L = 8\Omega$ , $C_L = 500pF$		20		dB
GBP	Gain Bandwidth Product $R_L = 8\Omega$		2		MHz

1. Standby mode is activated when  $V_{stdby}$  is tied to GND

2. Dynamic measurements -  $20 \cdot \log(\text{rms}(V_{out})/\text{rms}(V_{ripple}))$ .  $V_{ripple}$  is the surimposed sinus signal to  $V_{CC}$  @  $f = 217Hz$

$V_{CC} = +3.3V$ ,  $GND = 0V$ ,  $T_{amb} = 25^{\circ}C$  (unless otherwise specified)

Symbol	Parameter	Min.	Typ.	Max.	Unit
$I_{CC}$	Supply Current No input signal, no load		5.5	8	mA
$I_{STANDBY}$	Standby Current <sup>1)</sup> No input signal, $V_{stdby} = G_{ND}$ , $R_L = 8\Omega$		10	1000	nA
$V_{OO}$	Output Offset Voltage No input signal, $R_L = 8\Omega$		5	20	mV
$P_o$	Output Power THD = 1% Max, $f = 1kHz$ , $R_L = 8\Omega$		450		mW
THD + N	Total Harmonic Distortion + Noise $P_o = 250mW$ rms, $G_v = 2$ , $20Hz < f < 20kHz$ , $R_L = 8\Omega$		0.15		%
PSRR	Power Supply Rejection Ratio <sup>2)</sup> $f = 217Hz$ , $R_L = 8\Omega$ , $R_{Feed} = 22K\Omega$ , $V_{ripple} = 200mV$ rms		77		dB
$\Phi_M$	Phase Margin at Unity Gain $R_L = 8\Omega$ , $C_L = 500pF$		70		Degrees
GM	Gain Margin $R_L = 8\Omega$ , $C_L = 500pF$		20		dB
GBP	Gain Bandwidth Product $R_L = 8\Omega$		2		MHz

1. Standby mode is activated when  $V_{stdby}$  is tied to GND

2. Dynamic measurements -  $20 \cdot \log(\text{rms}(V_{out})/\text{rms}(V_{ripple}))$ .  $V_{ripple}$  is the surimposed sinus signal to  $V_{CC}$  @  $f = 217Hz$

## TS4890

$V_{CC} = 2.6V$ ,  $GND = 0V$ ,  $T_{amb} = 25^{\circ}C$  (unless otherwise specified)

Symbol	Parameter	Min.	Typ.	Max.	Unit
$I_{CC}$	Supply Current No input signal, no load		5	8	mA
$I_{STANDBY}$	Standby Current <sup>1)</sup> No input signal, $V_{stdby} = G_{ND}$ , $R_L = 8\Omega$		10	1000	nA
$V_{OO}$	Output Offset Voltage No input signal, $R_L = 8\Omega$		5	20	mV
$P_O$	Output Power THD = 1% Max, $f = 1kHz$ , $R_L = 8\Omega$		260		mW
THD + N	Total Harmonic Distortion + Noise $P_O = 200mW$ rms, $G_v = 2$ , $20Hz < f < 20kHz$ , $R_L = 8\Omega$		0.15		%
PSRR	Power Supply Rejection Ratio <sup>2)</sup> $f = 217Hz$ , $R_L = 8\Omega$ , $R_{Feed} = 22K\Omega$ , $V_{ripple} = 200mV$ rms		77		dB
$\Phi_M$	Phase Margin at Unity Gain $R_L = 8\Omega$ , $C_L = 500pF$		70		Degrees
GM	Gain Margin $R_L = 8\Omega$ , $C_L = 500pF$		20		dB
GBP	Gain Bandwidth Product $R_L = 8\Omega$		2		MHz

1. Standby mode is activated when  $V_{stdby}$  is tied to GND

2. Dynamic measurements -  $20 \cdot \log(\text{rms}(V_{out})/\text{rms}(V_{ripple}))$ . Vripple is the surimposed sinus signal to  $V_{CC}$  @  $f = 217Hz$

$V_{CC} = 2.2V$ ,  $GND = 0V$ ,  $T_{amb} = 25^{\circ}C$  (unless otherwise specified)

Symbol	Parameter	Min.	Typ.	Max.	Unit
$I_{CC}$	Supply Current No input signal, no load		5	8	mA
$I_{STANDBY}$	Standby Current <sup>1)</sup> No input signal, $V_{stdby} = G_{ND}$ , $R_L = 8\Omega$		10	1000	nA
$V_{OO}$	Output Offset Voltage No input signal, $R_L = 8\Omega$		5	20	mV
$P_O$	Output Power THD = 1% Max, $f = 1kHz$ , $R_L = 8\Omega$		180		mW
THD + N	Total Harmonic Distortion + Noise $P_O = 200mW$ rms, $G_v = 2$ , $20Hz < f < 20kHz$ , $R_L = 8\Omega$		0.15		%
PSRR	Power Supply Rejection Ratio <sup>2)</sup> $f = 217Hz$ , $R_L = 8\Omega$ , $R_{Feed} = 22K\Omega$ , $V_{ripple} = 100mV$ rms		77		dB
$\Phi_M$	Phase Margin at Unity Gain $R_L = 8\Omega$ , $C_L = 500pF$		70		Degrees
GM	Gain Margin $R_L = 8\Omega$ , $C_L = 500pF$		20		dB
GBP	Gain Bandwidth Product $R_L = 8\Omega$		2		MHz

1. Standby mode is activated when  $V_{stdby}$  is tied to GND

2. Dynamic measurements -  $20 \cdot \log(\text{rms}(V_{out})/\text{rms}(V_{ripple}))$ . Vripple is the surimposed sinus signal to  $V_{CC}$  @  $f = 217Hz$

Components	Functional Description
Rin	Inverting input resistor which sets the closed loop gain in conjunction with Rfeed. This resistor also forms a high pass filter with Cin ( $f_c = 1 / (2 \times \pi \times R_{in} \times C_{in})$ )
Cin	Input coupling capacitor which blocks the DC voltage at the amplifier input terminal
Rfeed	Feed back resistor which sets the closed loop gain in conjunction with Rin
Cs	Supply Bypass capacitor which provides power supply filtering
Cb	Bypass pin capacitor which provides half supply filtering
Cfeed	Low pass filter capacitor allowing to cut the high frequency (low pass filter cut-off frequency $1 / (2 \times \pi \times R_{feed} \times C_{feed})$ )
Rstb	Pull-down resistor which fixes the right supply level on the standby pin
Gv	Closed loop gain in BTL configuration = $2 \times (R_{feed} / R_{in})$

#### REMARKS

- All measurements, except PSRR measurements, are made with a supply bypass capacitor  $C_s = 100\mu\text{F}$ .
- External resistors are not needed for having better stability when supply @  $V_{cc}$  down to 3V. The quiescent current still remains the same.
- The standby response time is about  $1\mu\text{s}$ .

Fig. 1 : Open Loop Frequency Response

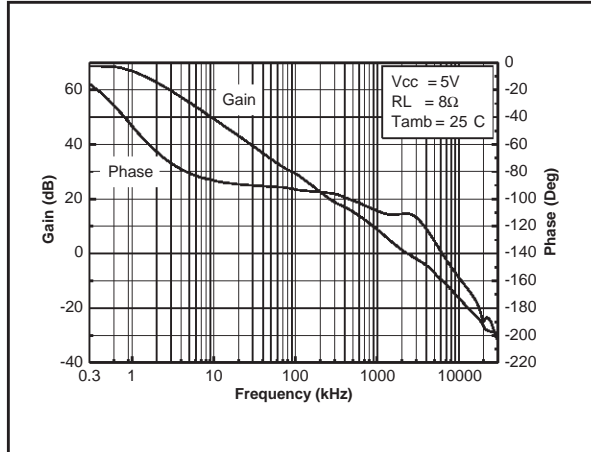


Fig. 2 : Open Loop Frequency Response

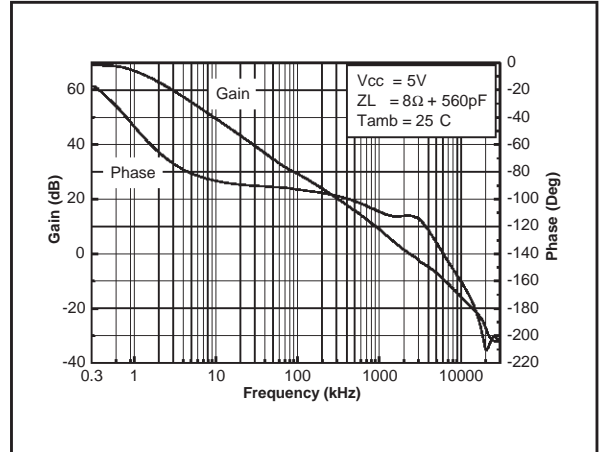


Fig. 3 : Open Loop Frequency Response

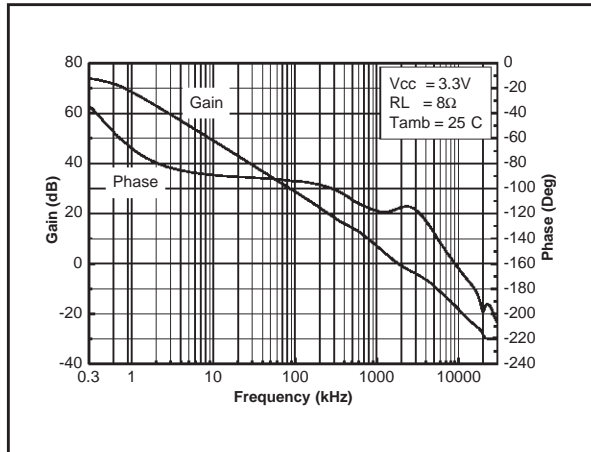


Fig. 4 : Open Loop Frequency Response

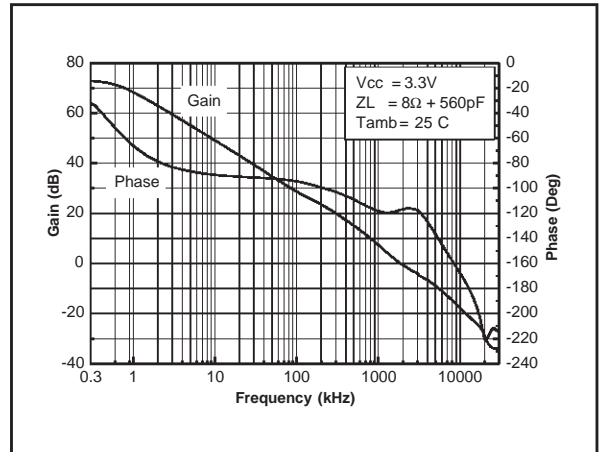


Fig. 5 : Open Loop Frequency Response

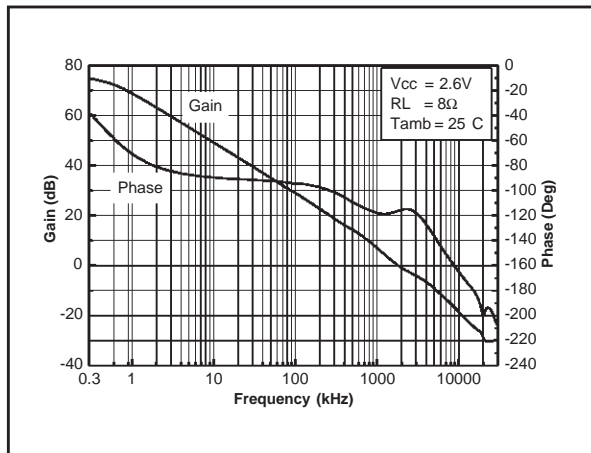


Fig. 6 : Open Loop Frequency Response

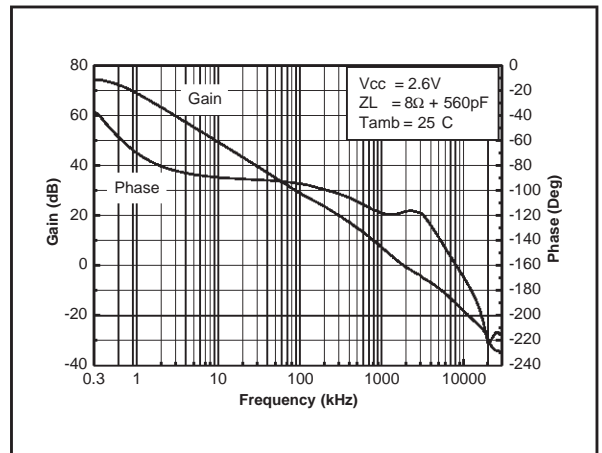


Fig. 7 : Open Loop Frequency Response

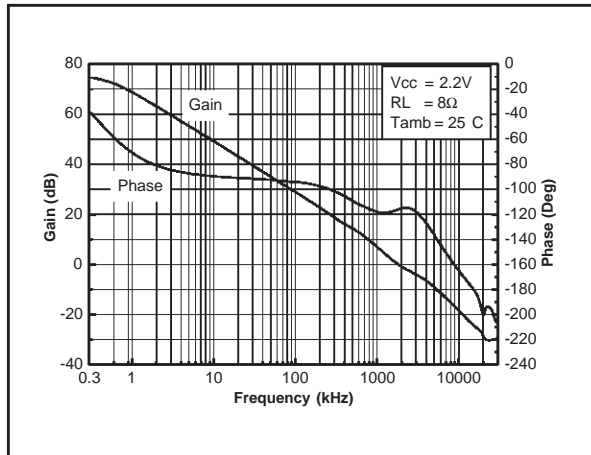


Fig. 8 : Open Loop Frequency Response

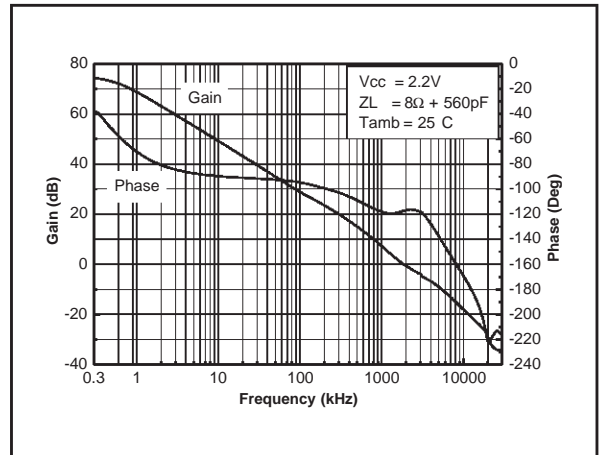


Fig. 9 : Open Loop Frequency Response

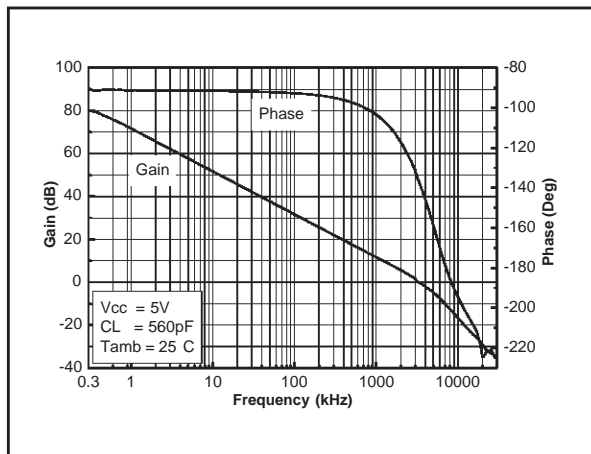


Fig. 10 : Open Loop Frequency Response

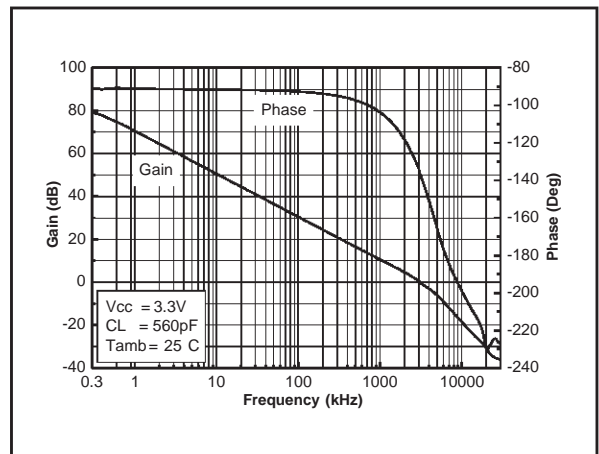


Fig. 11 : Open Loop Frequency Response

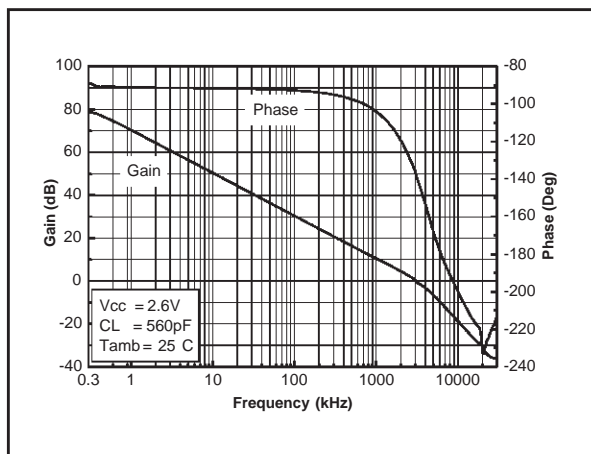
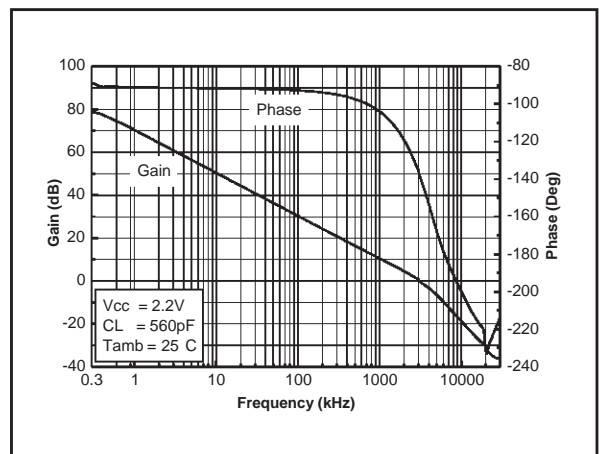
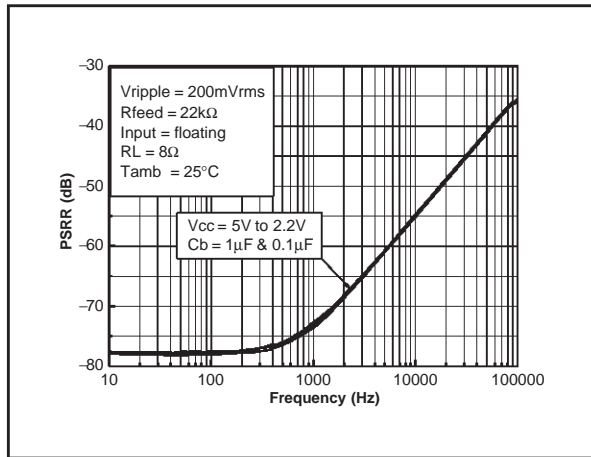


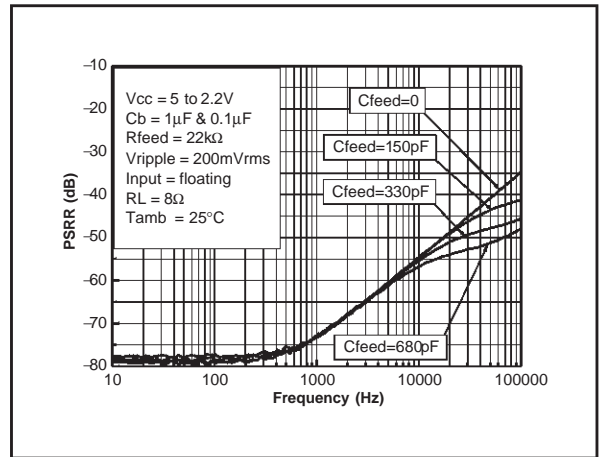
Fig. 12 : Open Loop Frequency Response



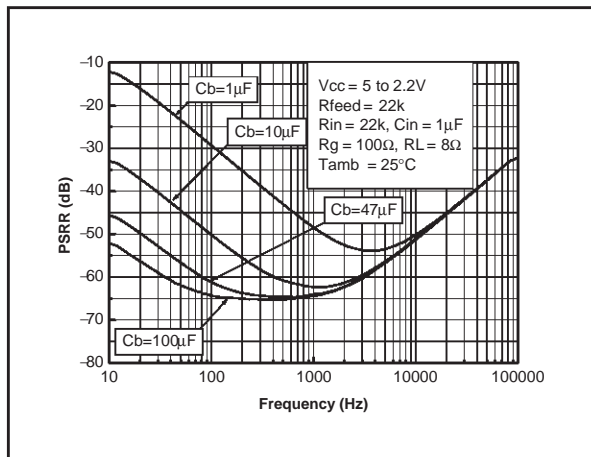
**Fig. 13 : Power Supply Rejection Ratio (PSRR) vs Power supply**



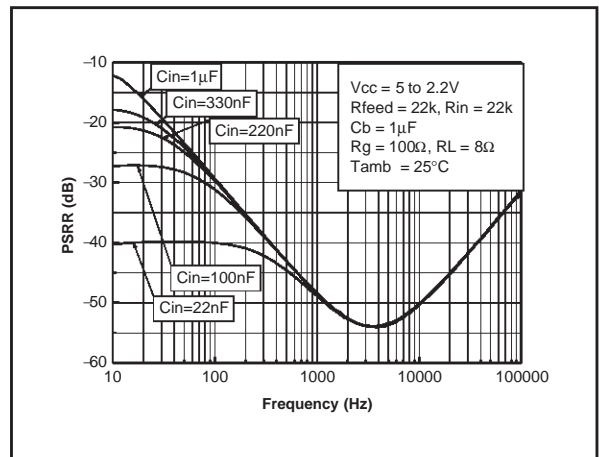
**Fig. 14 : Power Supply Rejection Ratio (PSRR) vs Feedback Capacitor**



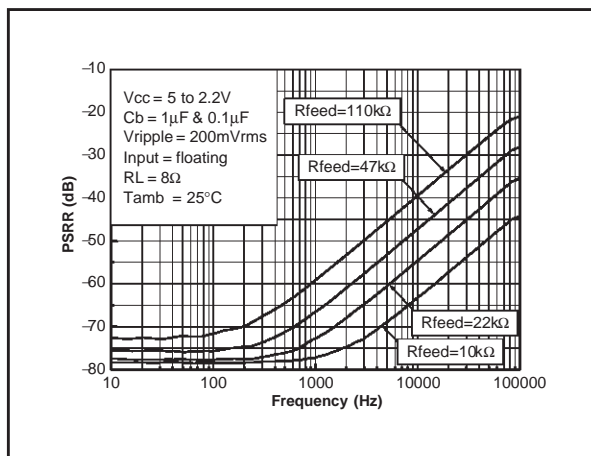
**Fig. 15 : Power Supply Rejection Ratio (PSRR) vs Bypass Capacitor**



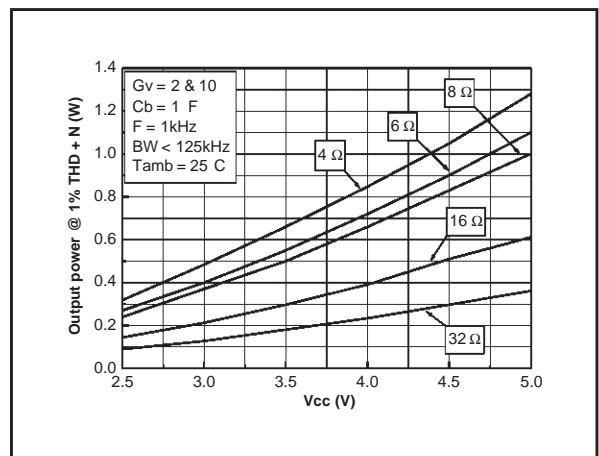
**Fig. 16 : Power Supply Rejection Ratio (PSRR) vs Input Capacitor**



**Fig. 17 : Power Supply Rejection Ratio (PSRR) vs Feedback Resistor**

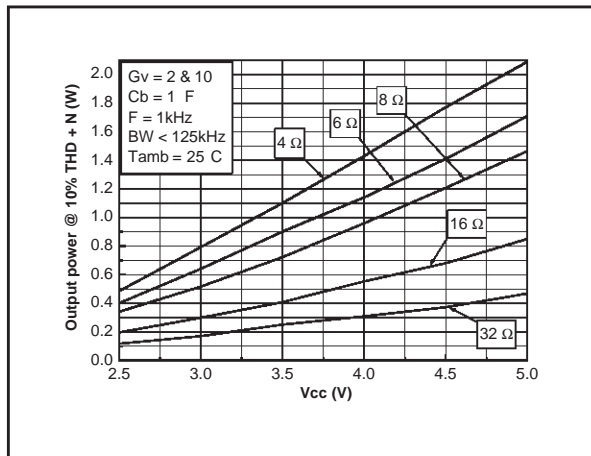


**Fig. 18 : Pout @ THD + N = 1% vs Supply Voltage vs RL**

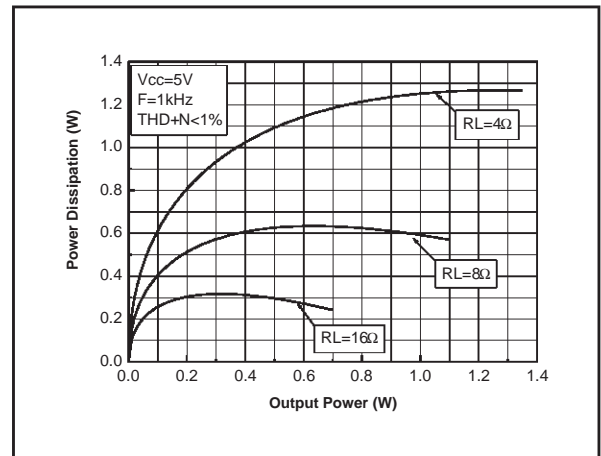




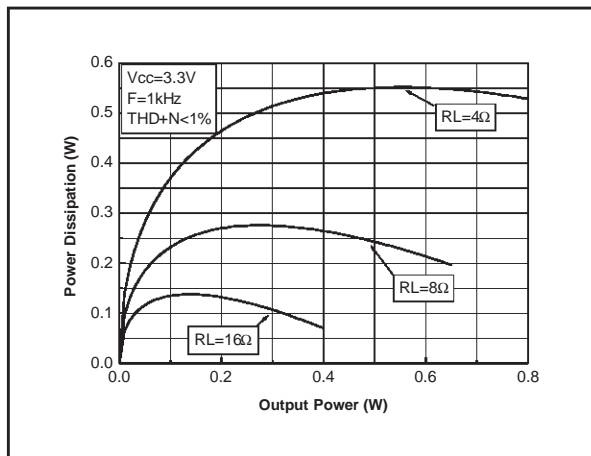
**Fig. 19 : Pout @ THD + N = 10% vs Supply Voltage vs RL**



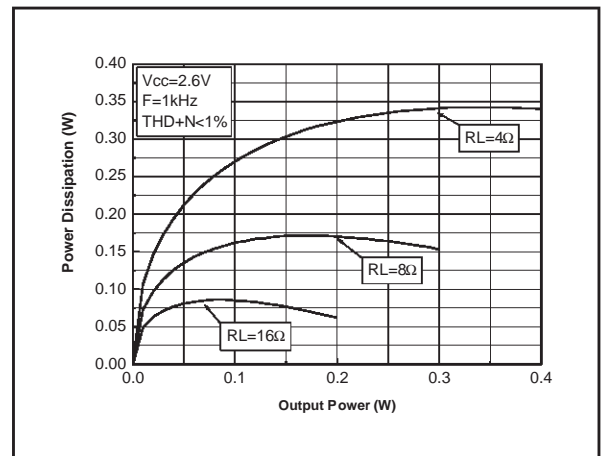
**Fig. 20 : Power Dissipation vs Pout**



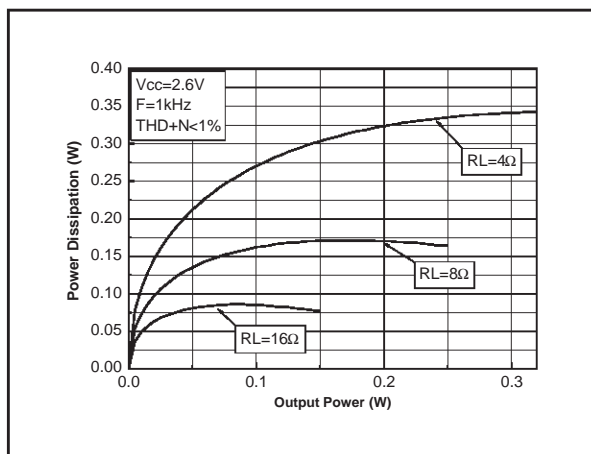
**Fig. 21 : Power Dissipation vs Pout**



**Fig. 22 : Power Dissipation vs Pout**



**Fig. 23 : Power Dissipation vs Pout**



**Fig. 24 : Power Derating Curves**

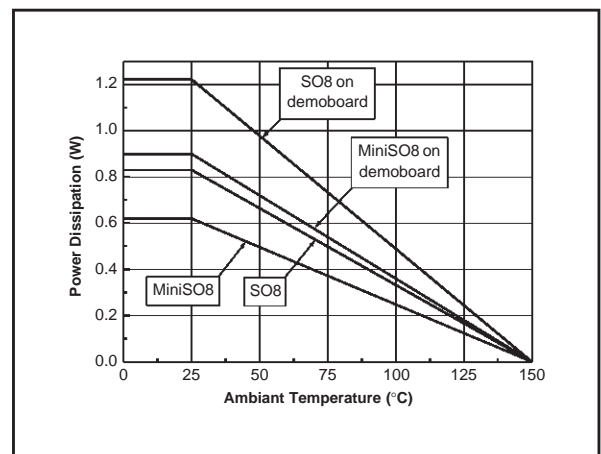


Fig. 25 : THD + N vs Output Power

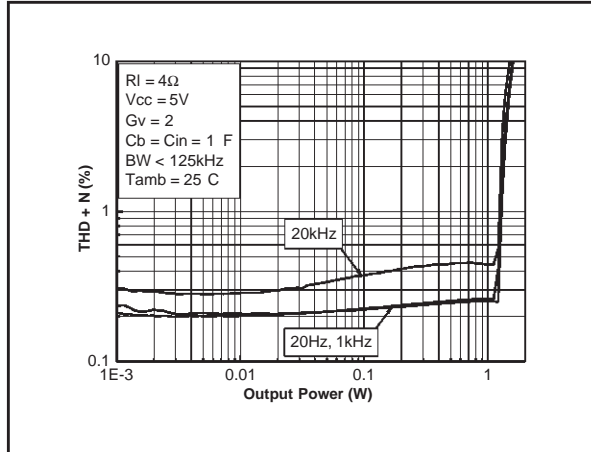


Fig. 26 : THD + N vs Output Power

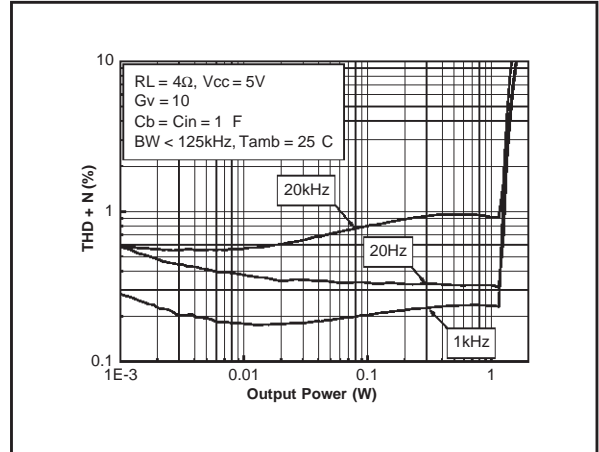


Fig. 27 : THD + N vs Output Power

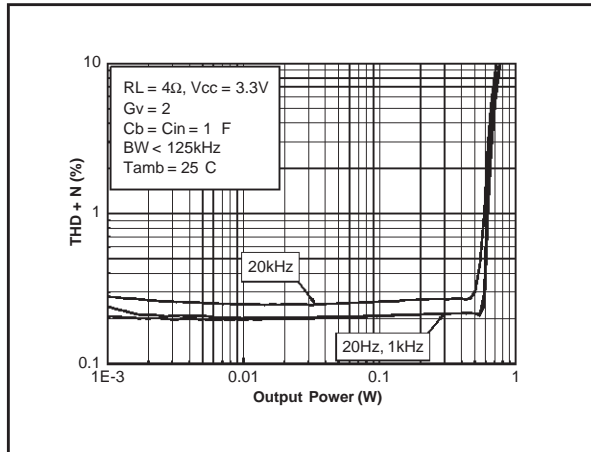


Fig. 28 : THD + N vs Output Power

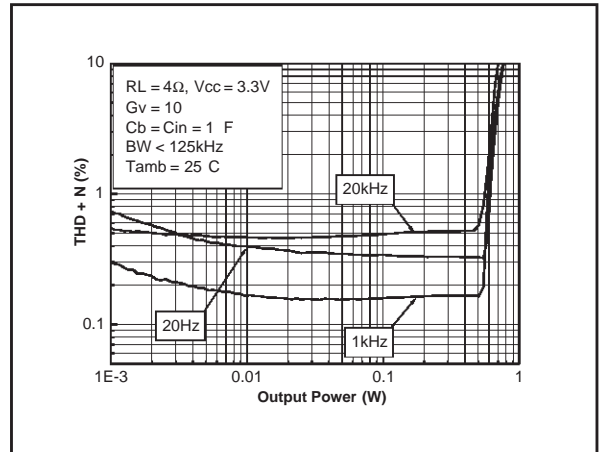


Fig. 29 : THD + N vs Output Power

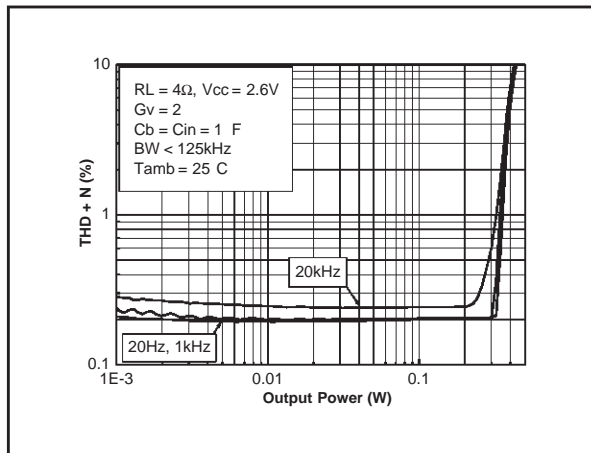


Fig. 30 : THD + N vs Output Power

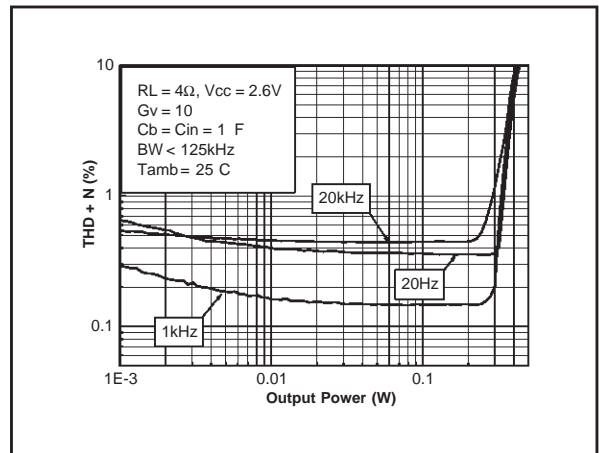


Fig. 31 : THD + N vs Output Power

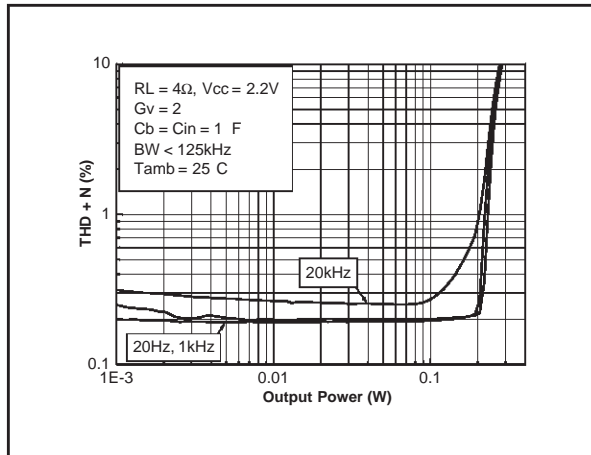


Fig. 32 : THD + N vs Output Power

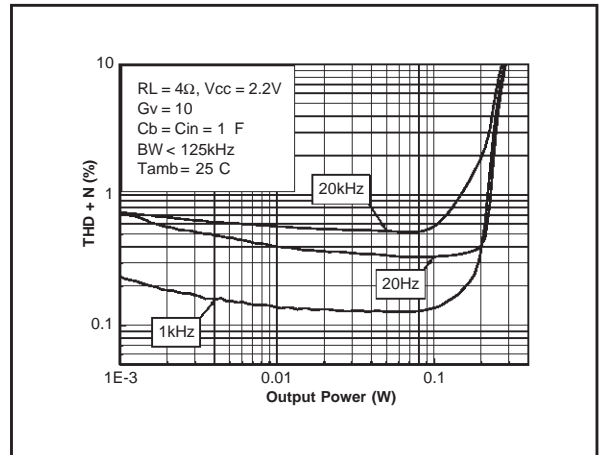


Fig. 33 : THD + N vs Output Power

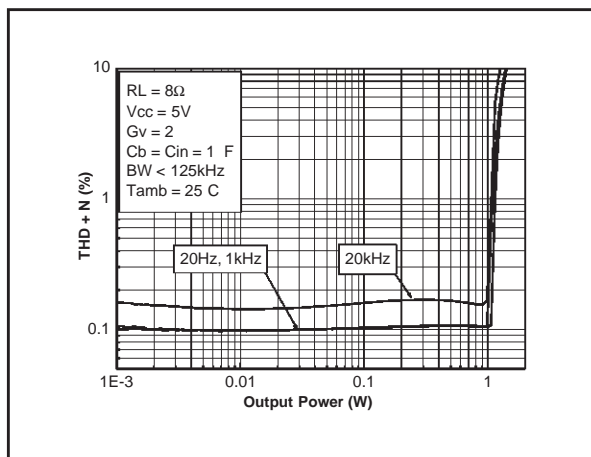


Fig. 34 : THD + N vs Output Power

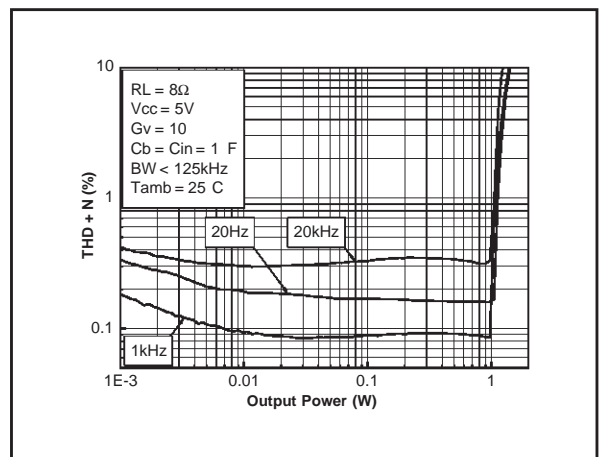


Fig. 35 : THD + N vs Output Power

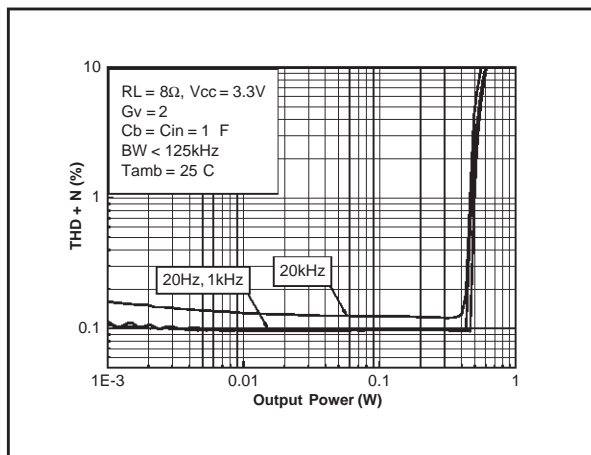


Fig. 36 : THD + N vs Output Power

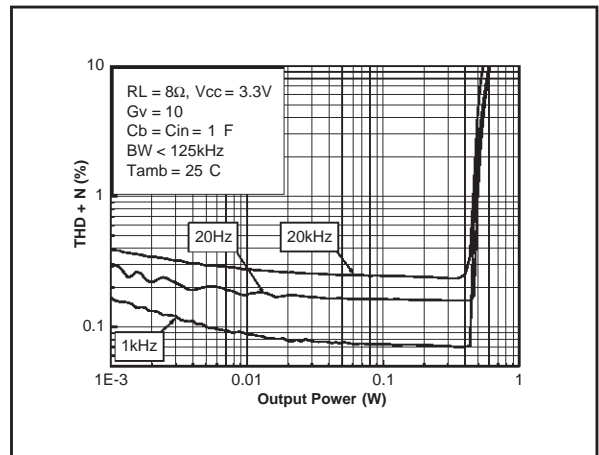


Fig. 37 : THD + N vs Output Power

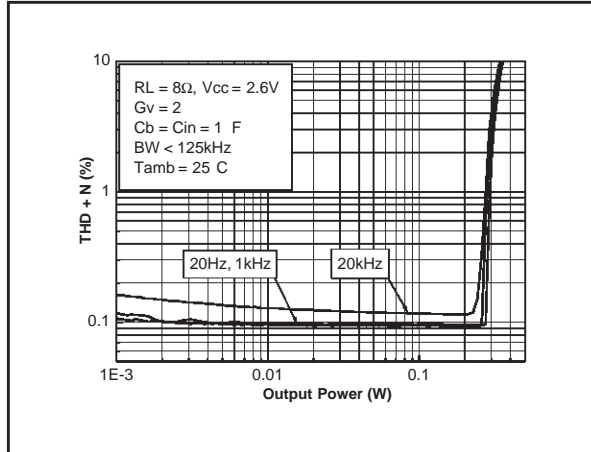


Fig. 38 : THD + N vs Output Power

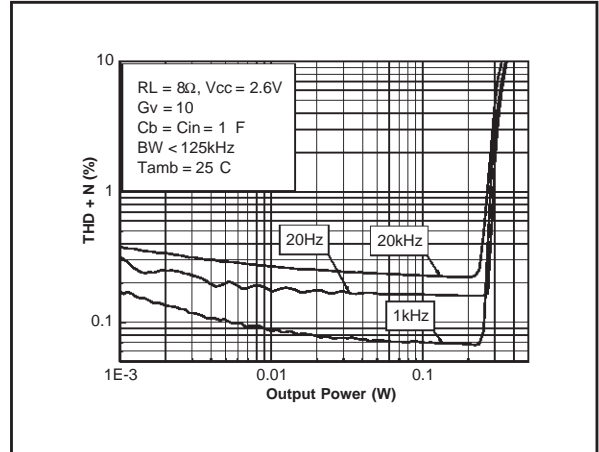


Fig. 39 : THD + N vs Output Power

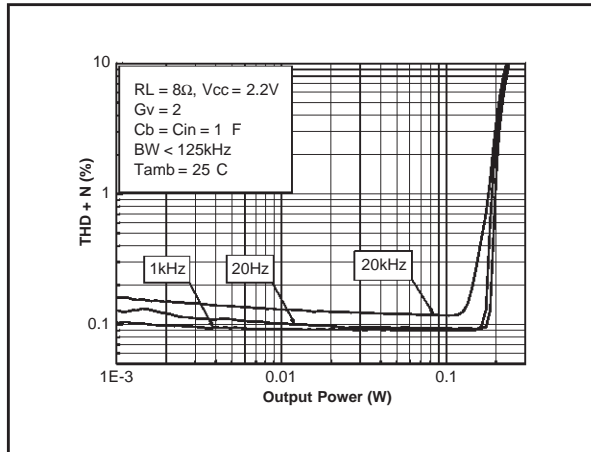


Fig. 40 : THD + N vs Output Power

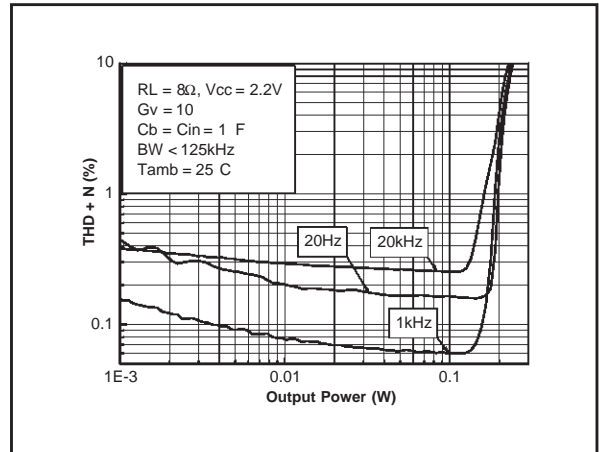


Fig. 41 : THD + N vs Output Power

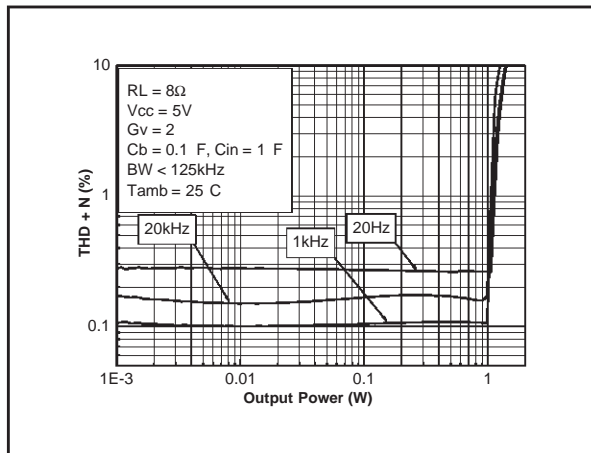


Fig. 42 : THD + N vs Output Power

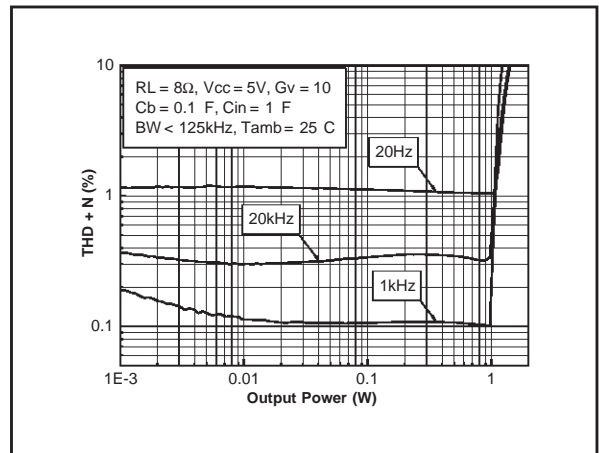


Fig. 43 : THD + N vs Output Power

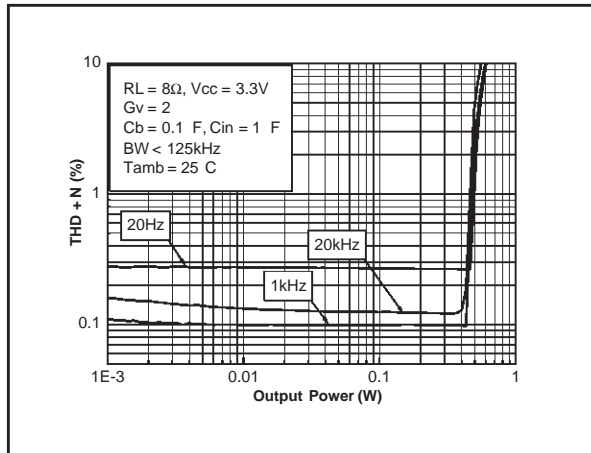


Fig. 44 : THD + N vs Output Power

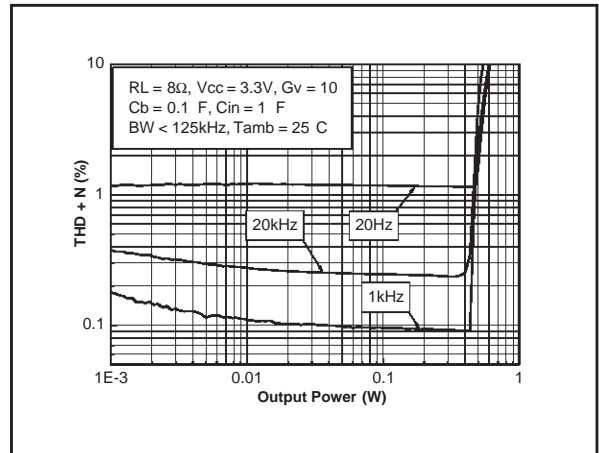


Fig. 45 : THD + N vs Output Power

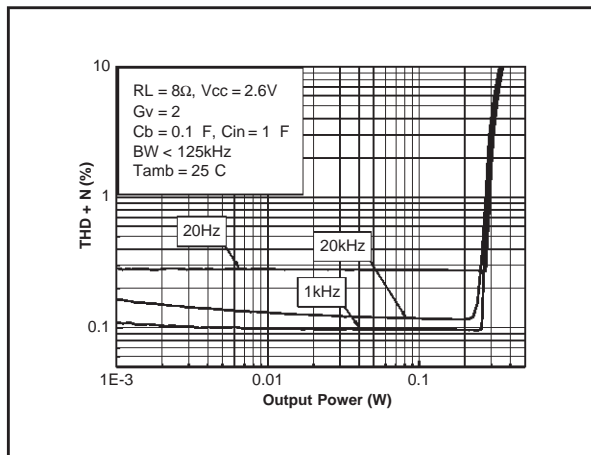


Fig. 46 : THD + N vs Output Power

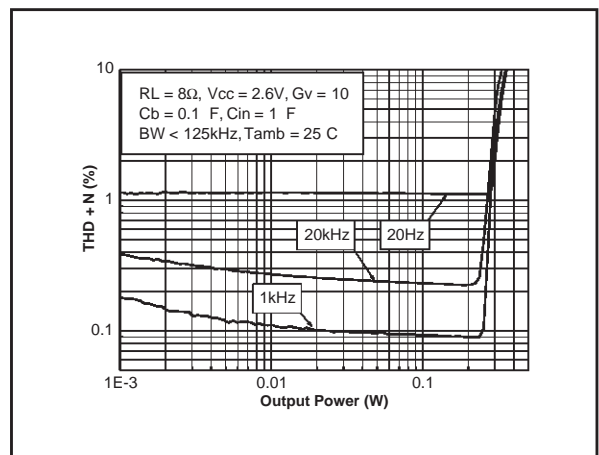


Fig. 47 : THD + N vs Output Power

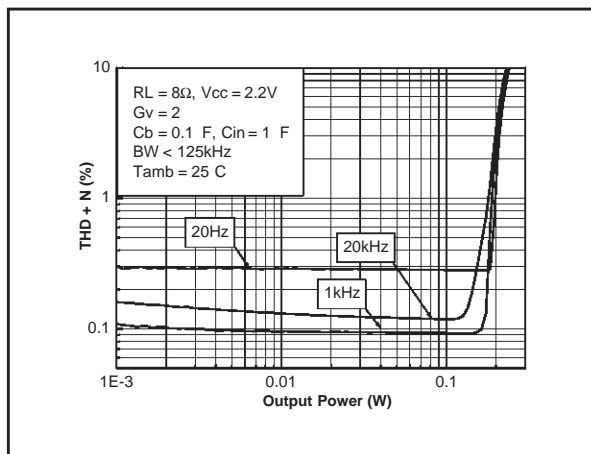


Fig. 48 : THD + N vs Output Power

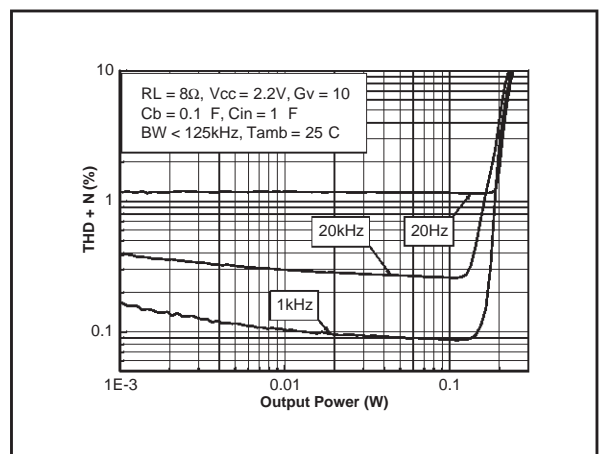


Fig. 49 : THD + N vs Output Power

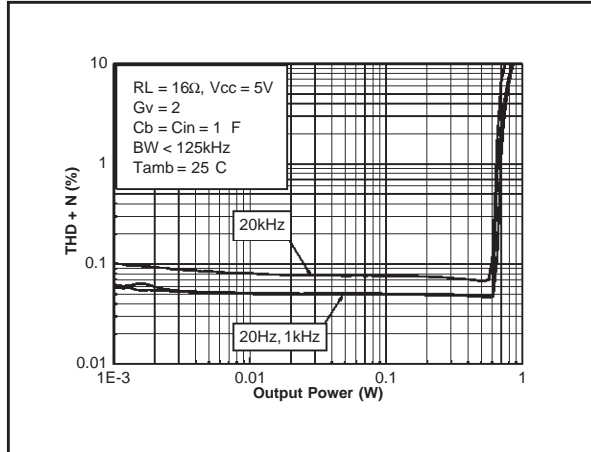


Fig. 50 : THD + N vs Output Power

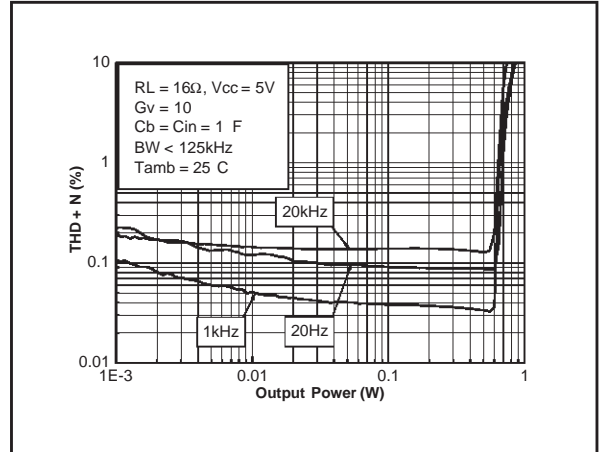


Fig. 51 : THD + N vs Output Power

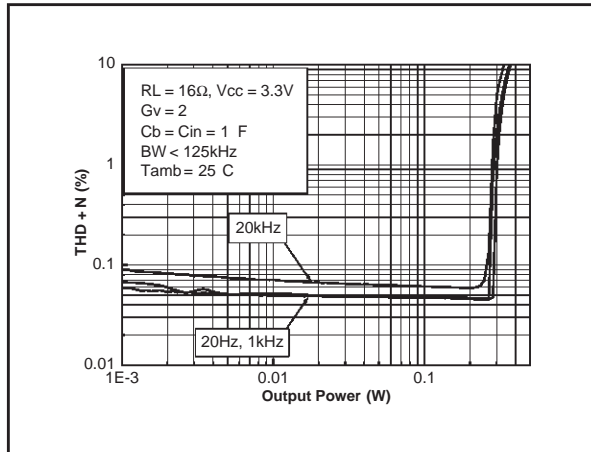


Fig. 52 : THD + N vs Output Power

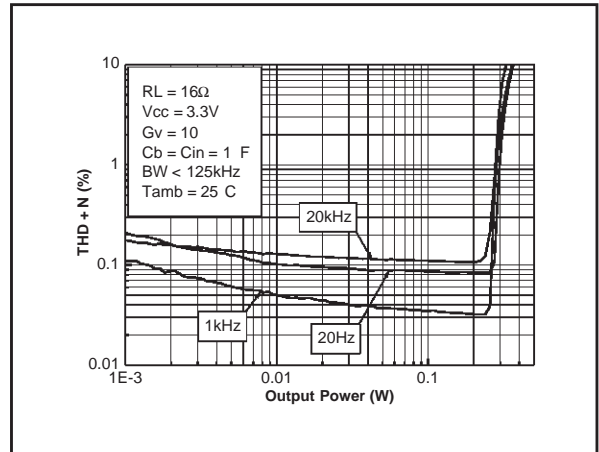


Fig. 53 : THD + N vs Output Power

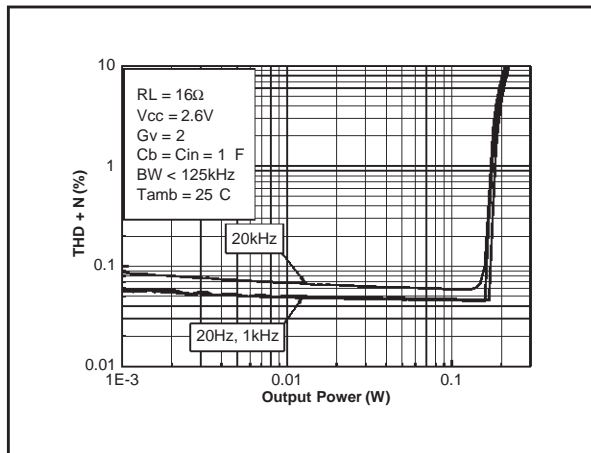


Fig. 54 : THD + N vs Output Power

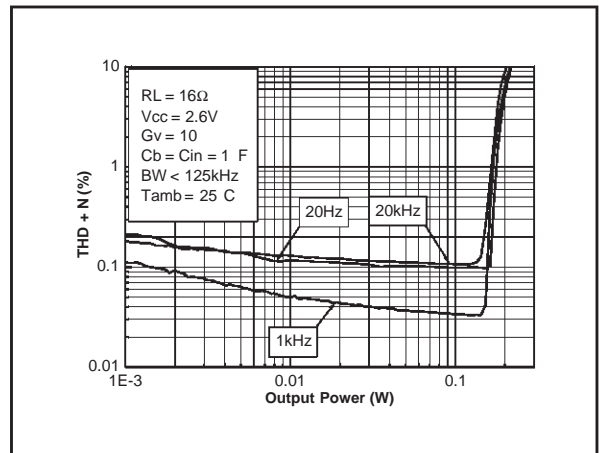


Fig. 55 : THD + N vs Output Power

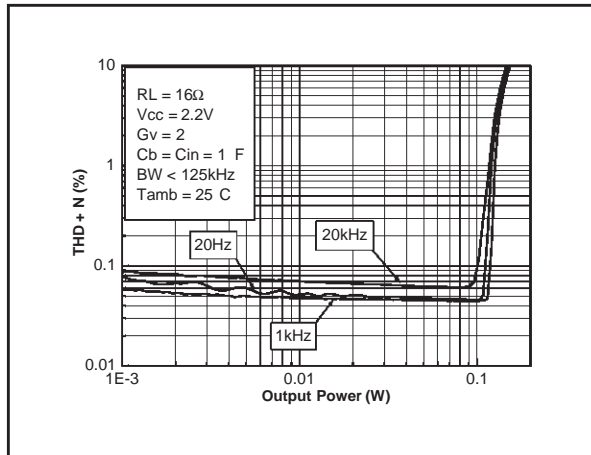


Fig. 56 : THD + N vs Output Power

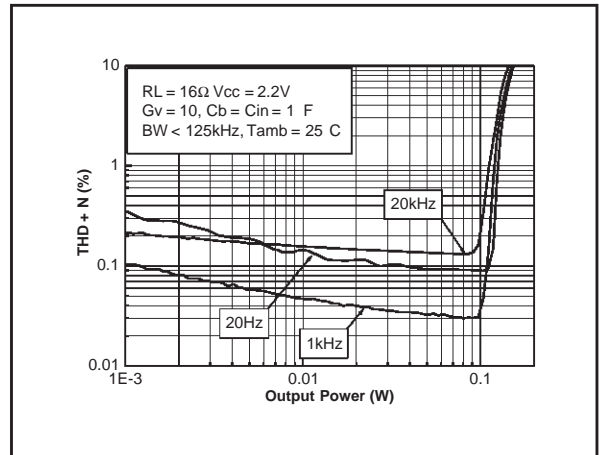


Fig. 57 : THD + N vs Frequency

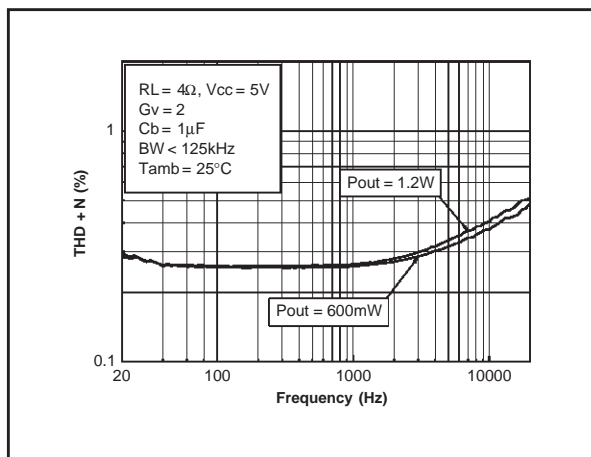


Fig. 58 : THD + N vs Frequency

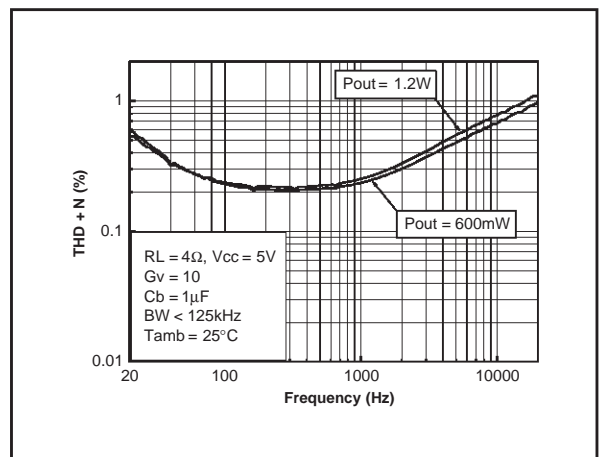


Fig. 59 : THD + N vs Frequency

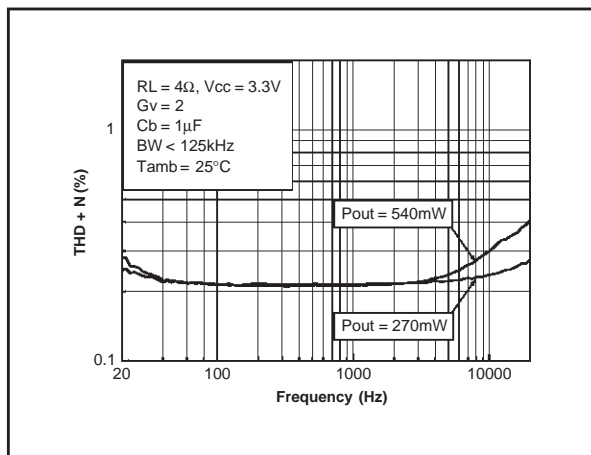


Fig. 60 : THD + N vs Frequency

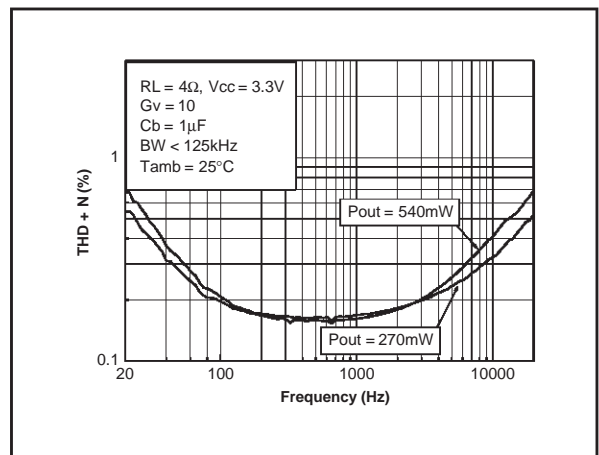


Fig. 61 : THD + N vs Frequency

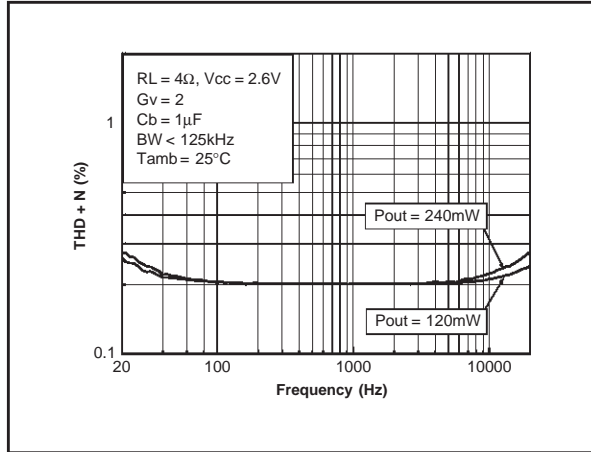


Fig. 62 : THD + N vs Frequency

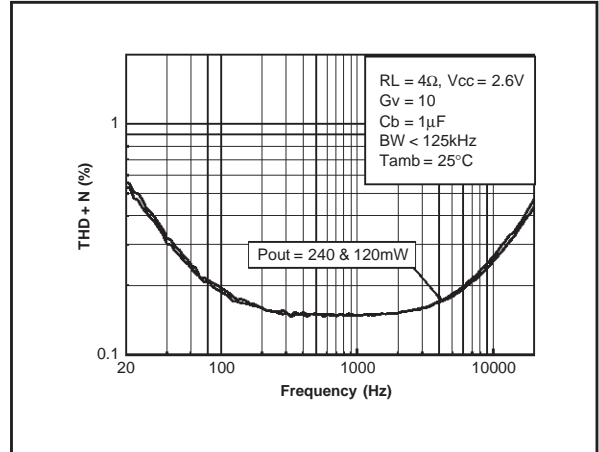


Fig. 63 : THD + N vs Frequency

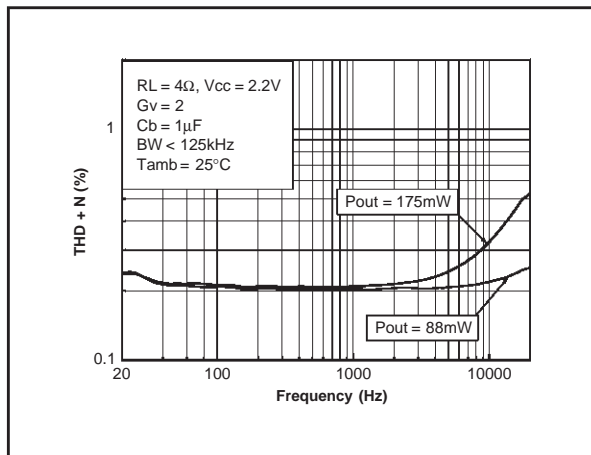


Fig. 64 : THD + N vs Frequency

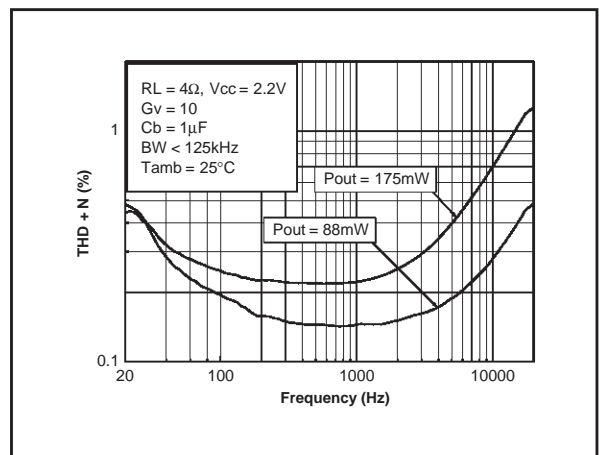


Fig. 65 : THD + N vs Frequency

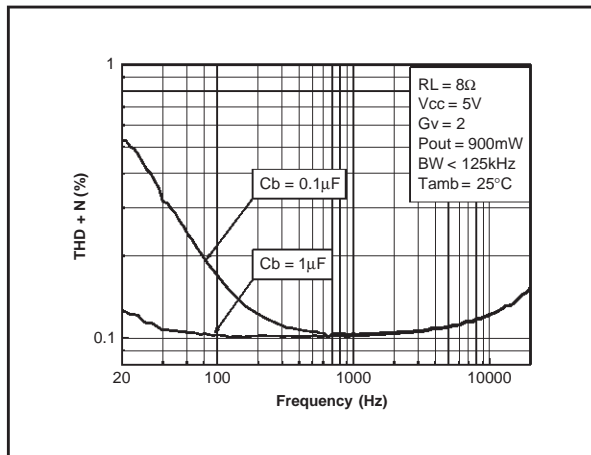


Fig. 66 : THD + N vs Frequency

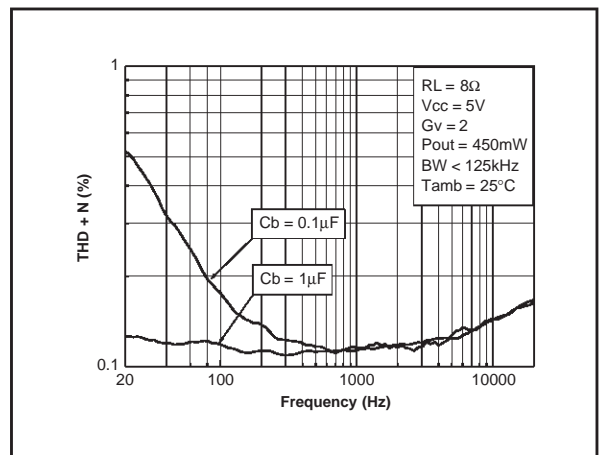




Fig. 67 : THD + N vs Frequency

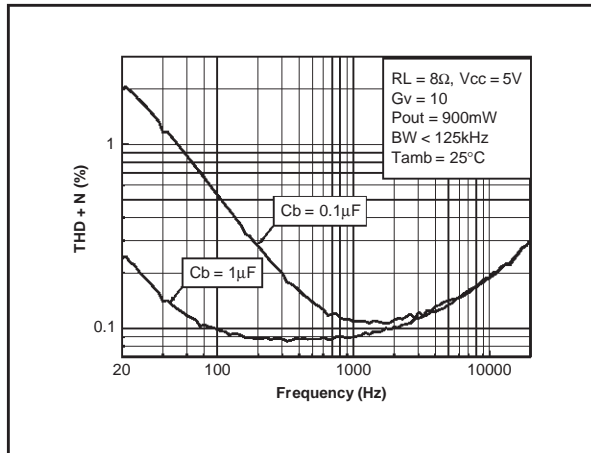


Fig. 68 : THD + N vs Frequency

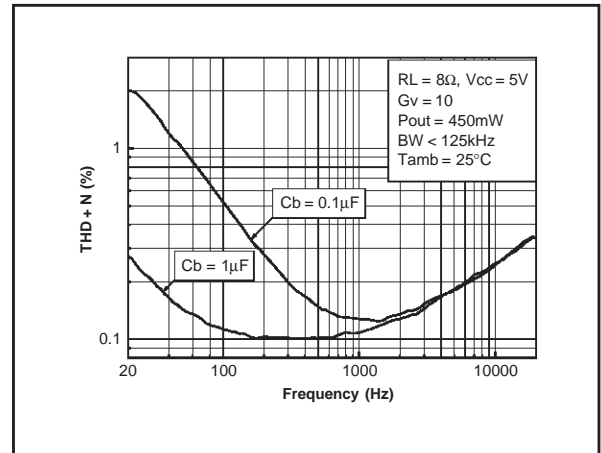


Fig. 69 : THD + N vs Frequency

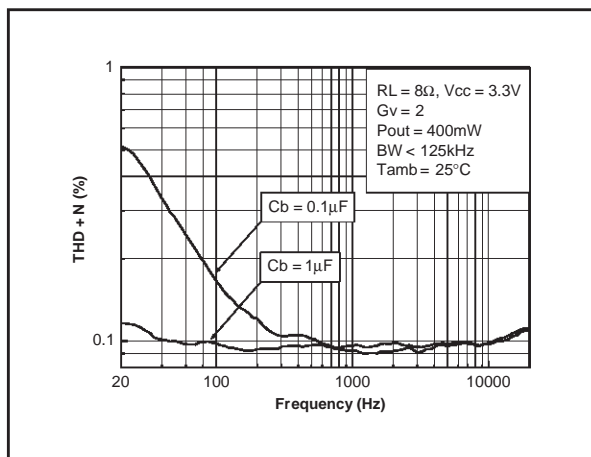


Fig. 70 : THD + N vs Frequency

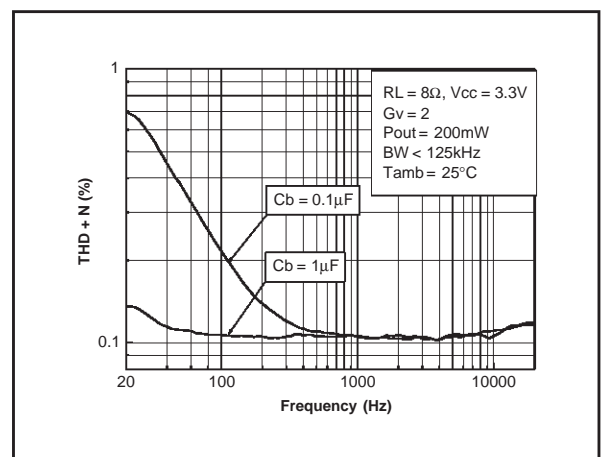


Fig. 71 : THD + N vs Frequency

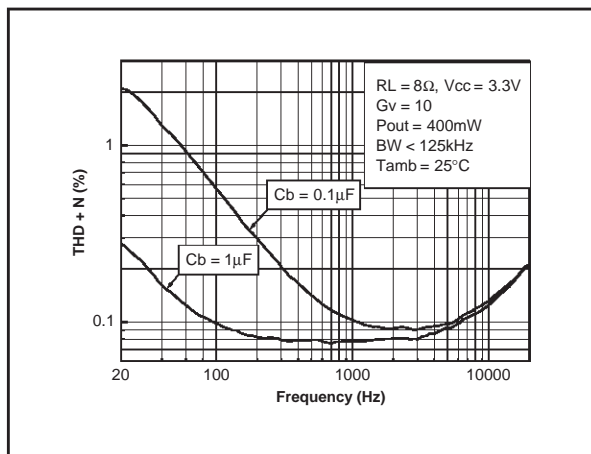


Fig. 72 : THD + N vs Frequency

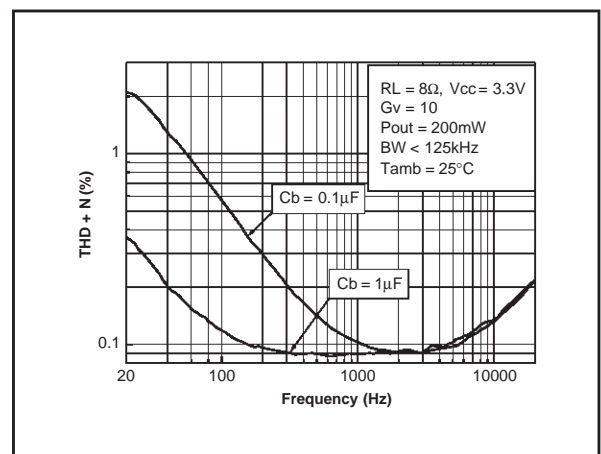


Fig. 73 : THD + N vs Frequency

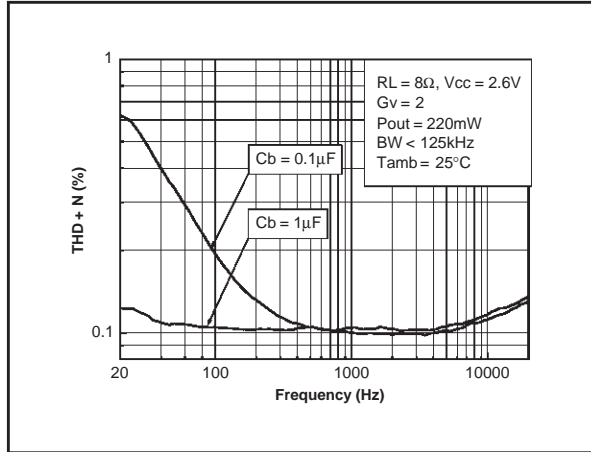


Fig. 74 : THD + N vs Frequency

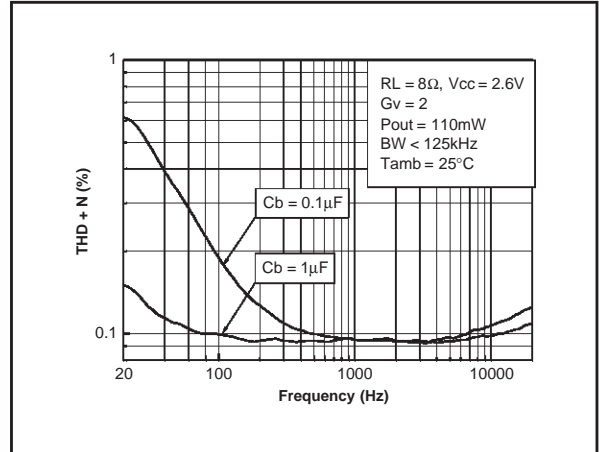


Fig. 75 : THD + N vs Frequency

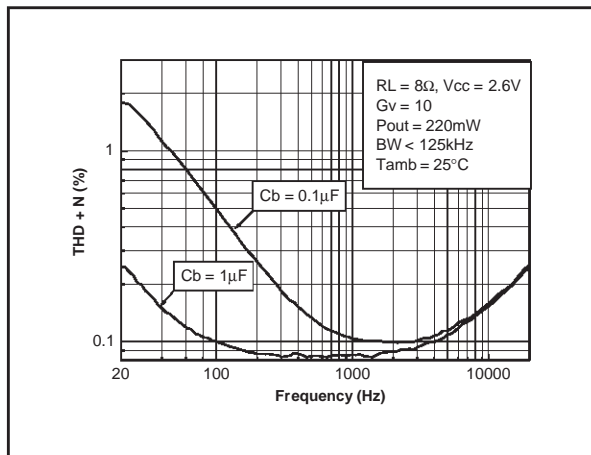


Fig. 76 : THD + N vs Frequency

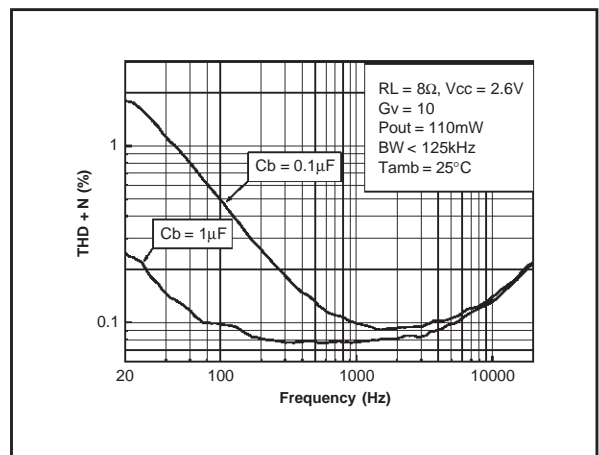


Fig. 77 : THD + N vs Frequency

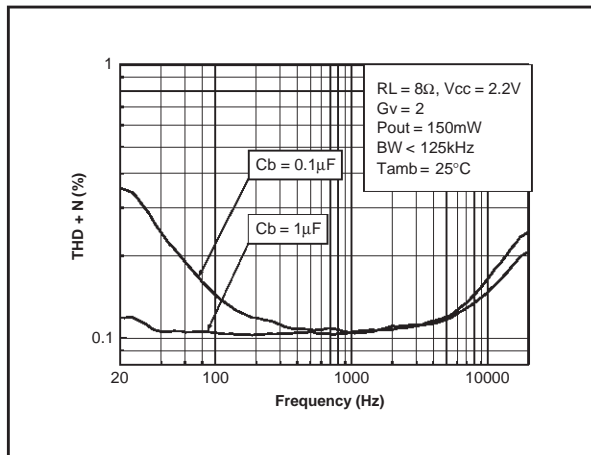


Fig. 78 : THD + N vs Frequency

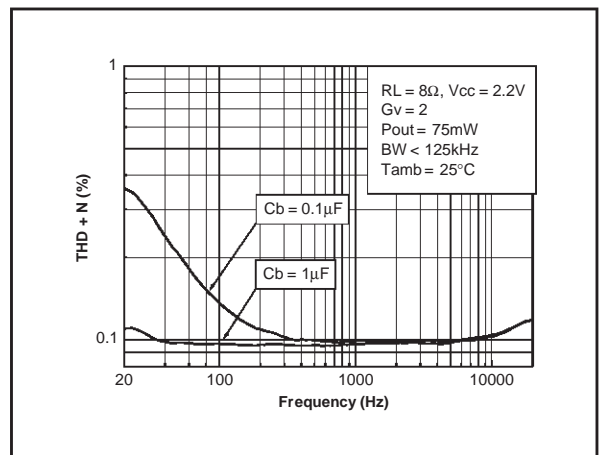


Fig. 79 : THD + N vs Frequency

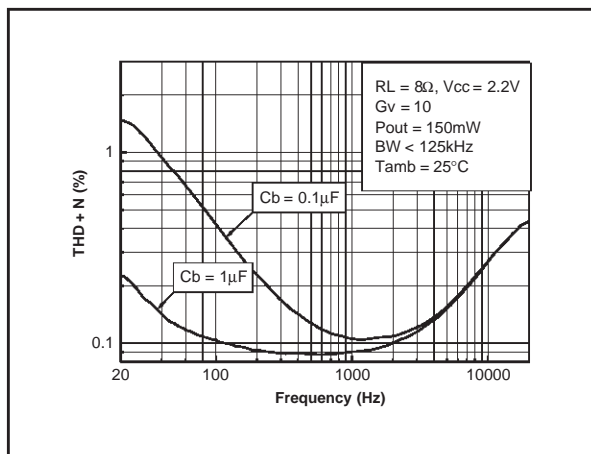


Fig. 80 : THD + N vs Frequency

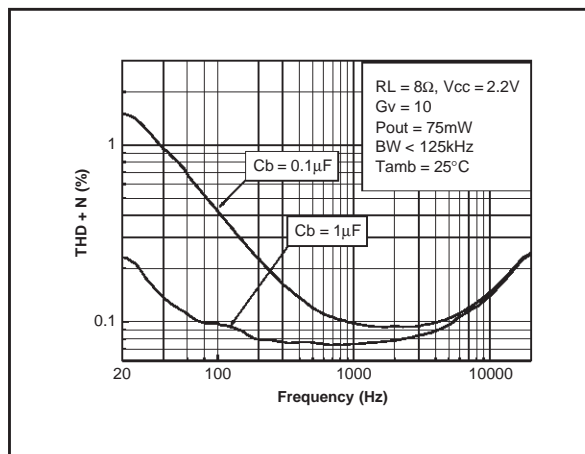


Fig. 81 : THD + N vs Frequency

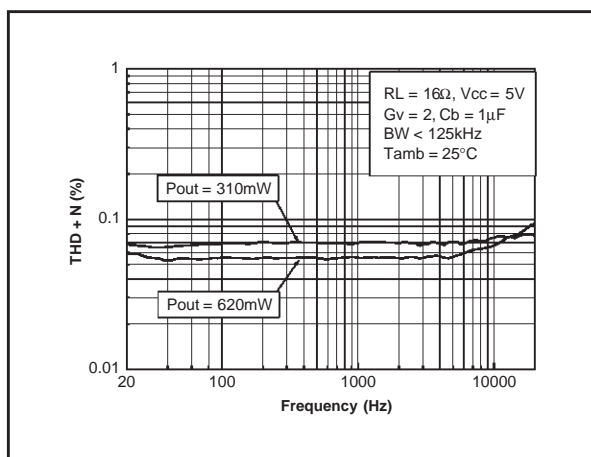


Fig. 82 : THD + N vs Frequency

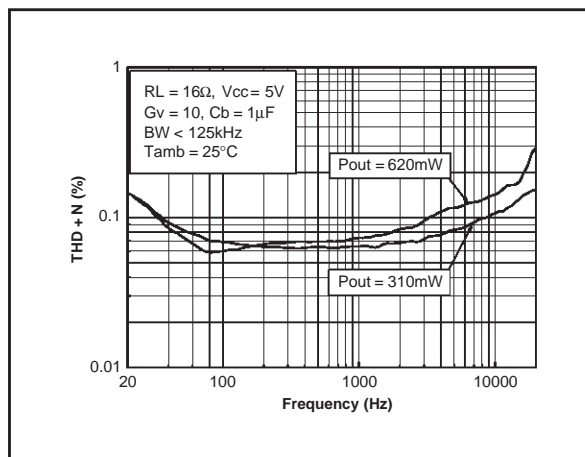


Fig. 83 : THD + N vs Frequency

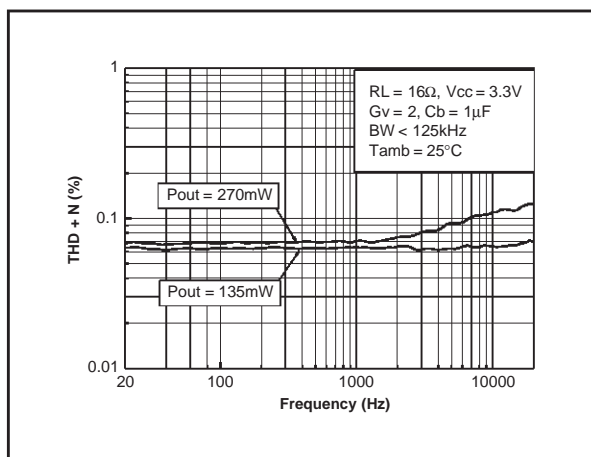


Fig. 84 : THD + N vs Frequency

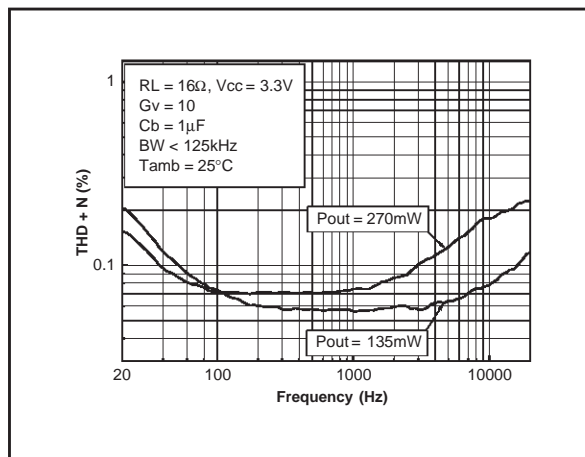


Fig. 85 : THD + N vs Frequency

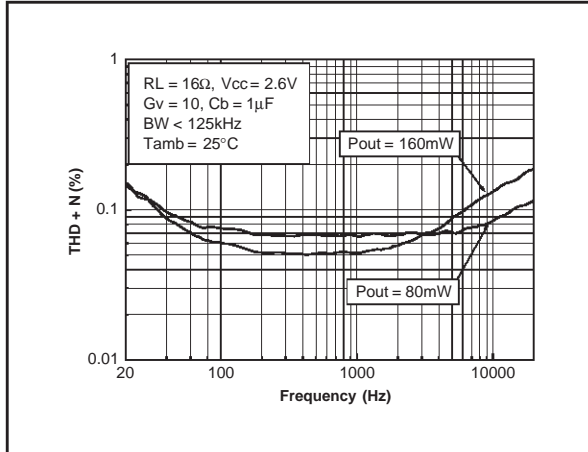


Fig. 86 : THD + N vs Frequency

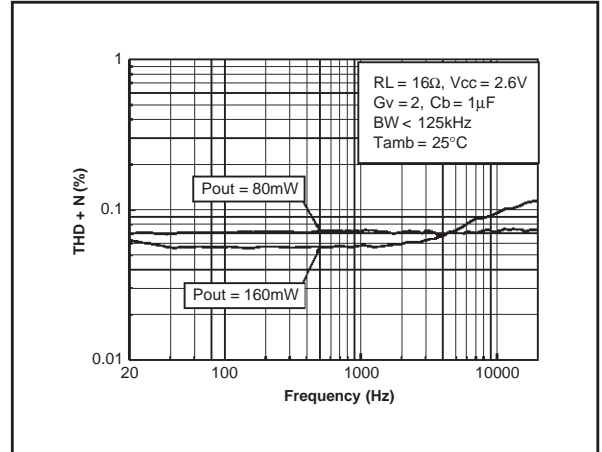


Fig. 87 : THD + N vs Frequency

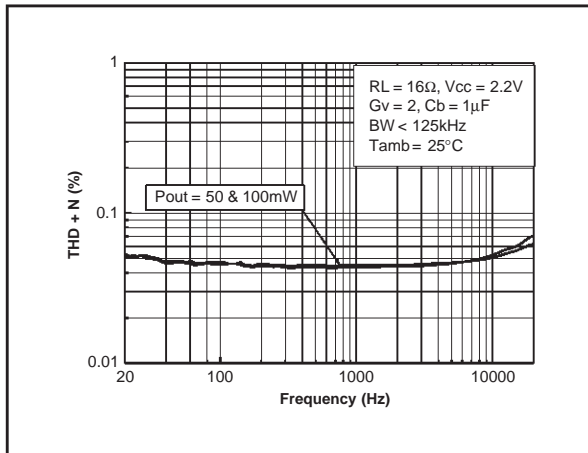


Fig. 88 : THD + N vs Frequency

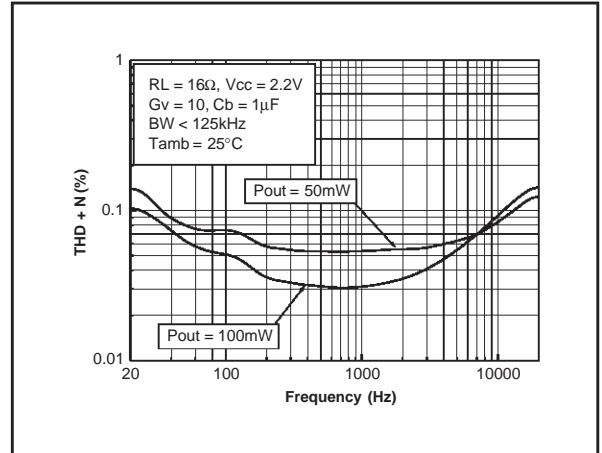


Fig. 89 : Signal to Noise Ratio vs Power Supply with Unweighted Filter (20Hz to 20kHz)

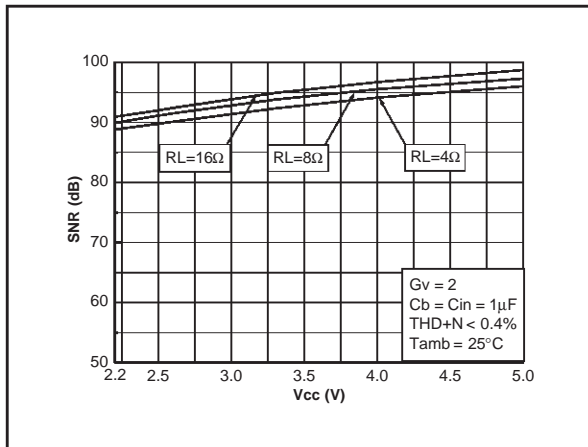
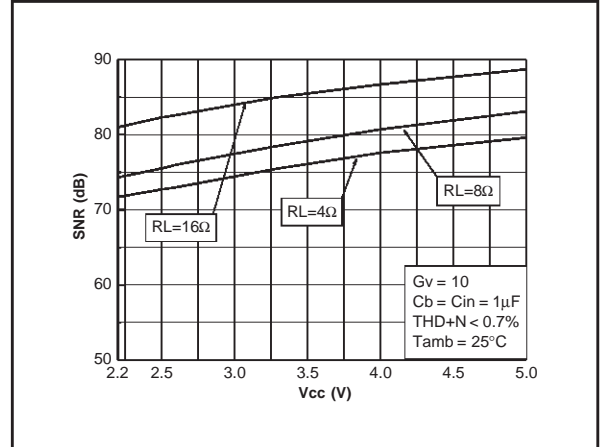
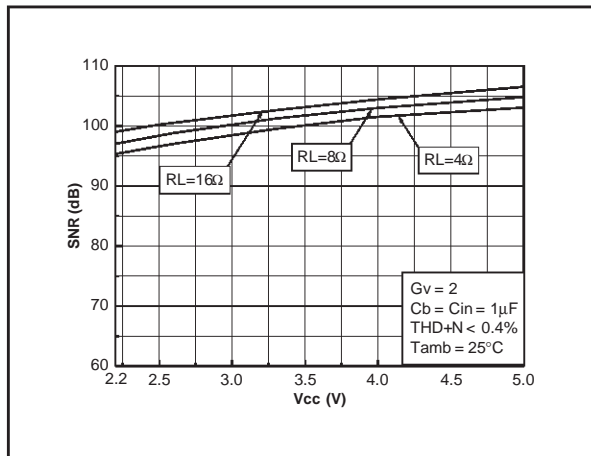


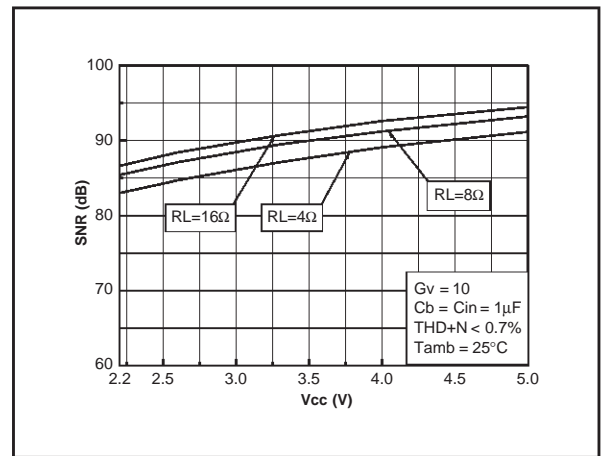
Fig. 90 : Signal to Noise Ratio Vs Power Supply with Unweighted Filter (20Hz to 20kHz)



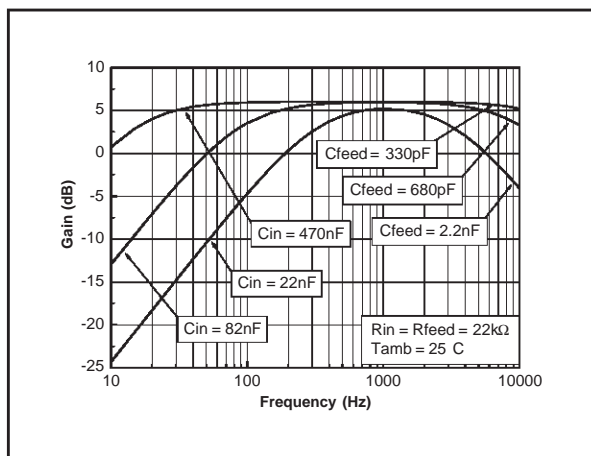
**Fig. 91 : Signal to Noise Ratio vs Power Supply with Weighted Filter type A**



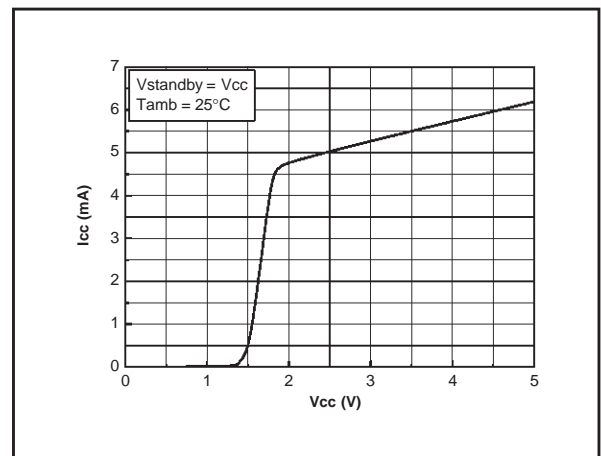
**Fig. 92 : Signal to Noise Ratio vs Power Supply with Weighted Filter Type A**



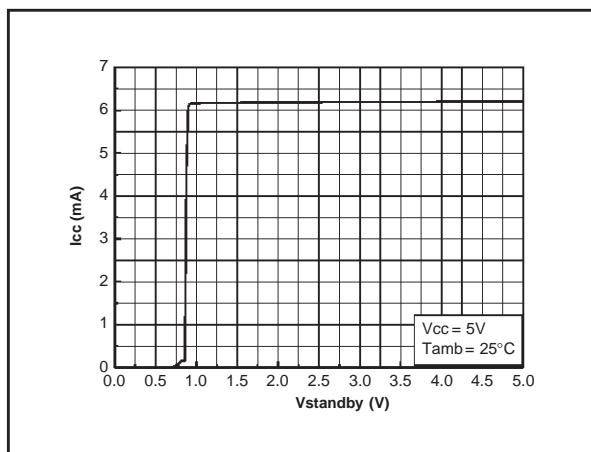
**Fig. 93 : Frequency Response Gain vs Cin, & Cfeed**



**Fig. 94 : Current Consumption vs Power Supply Voltage (no load)**



**Fig. 95 : Current Consumption vs Standby Voltage @ Vcc = 5V**



**Fig. 96 : Current Consumption vs Standby Voltage @ Vcc = 3.3V**

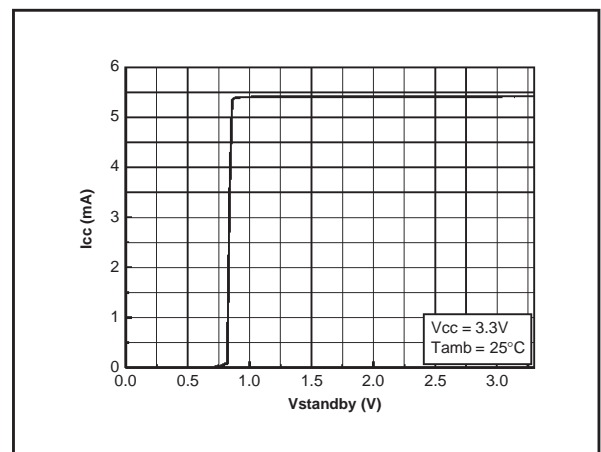


Fig. 97 : Current Consumption vs Standby Voltage @ Vcc = 2.6V

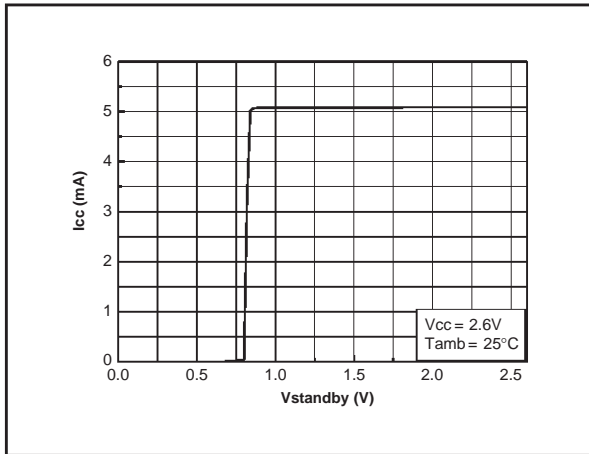


Fig. 98 : Current Consumption vs Standby Voltage @ Vcc = 2.2V

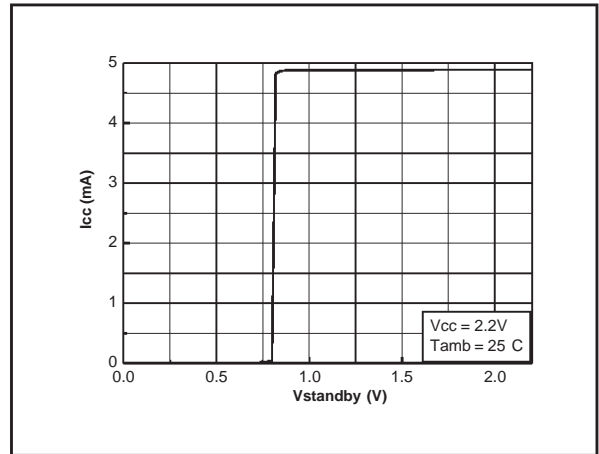


Fig. 99 : Clipping Voltage vs Power Supply Voltage and Load Resistor

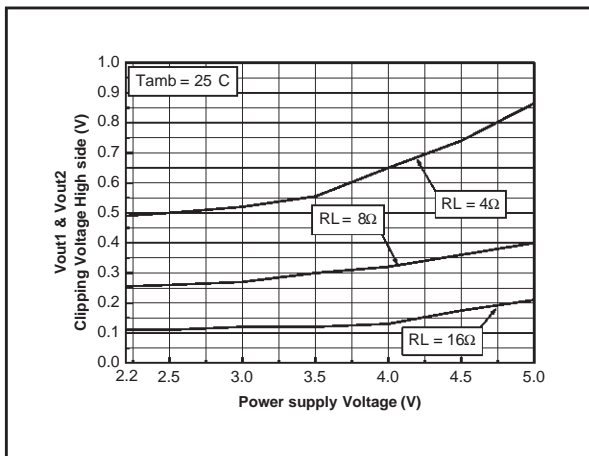
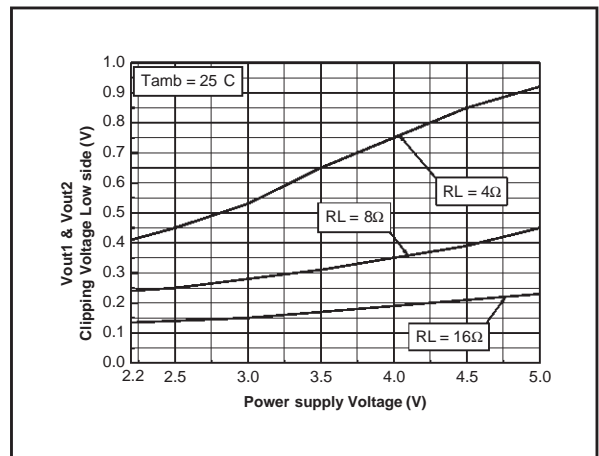


Fig. 100 : Clipping Voltage vs Power Supply Voltage and Load Resistor



APPLICATION INFORMATION

Fig. 101 : Demoboard Schematic

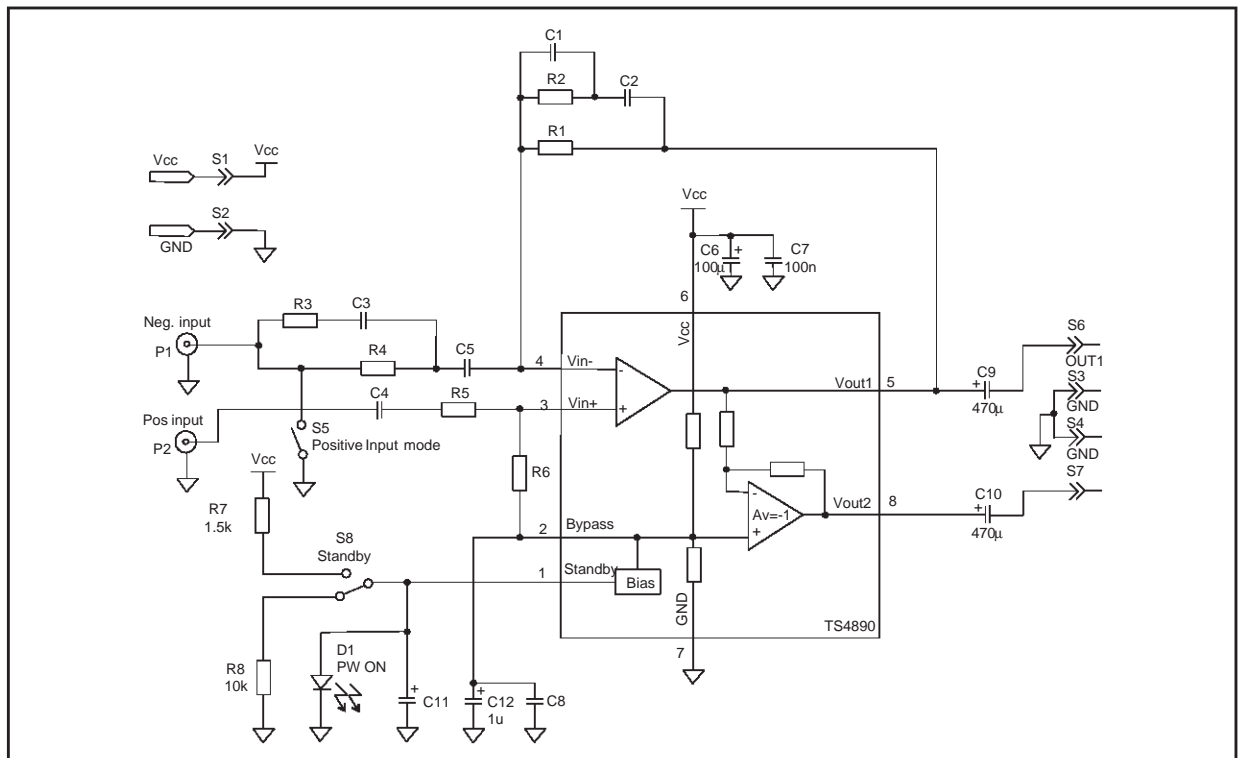
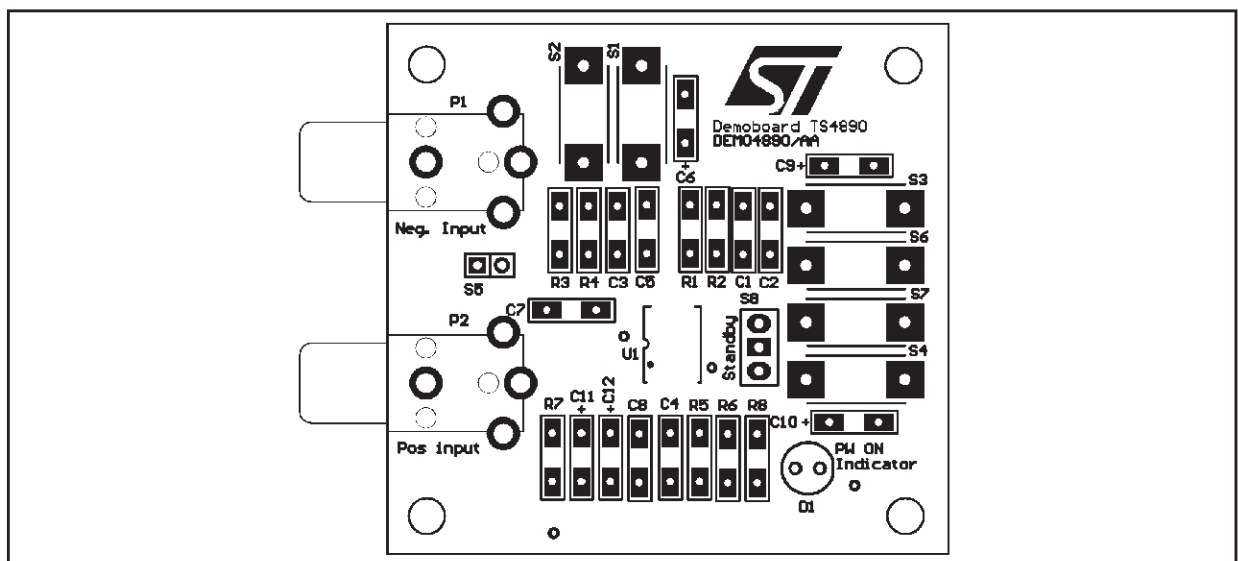
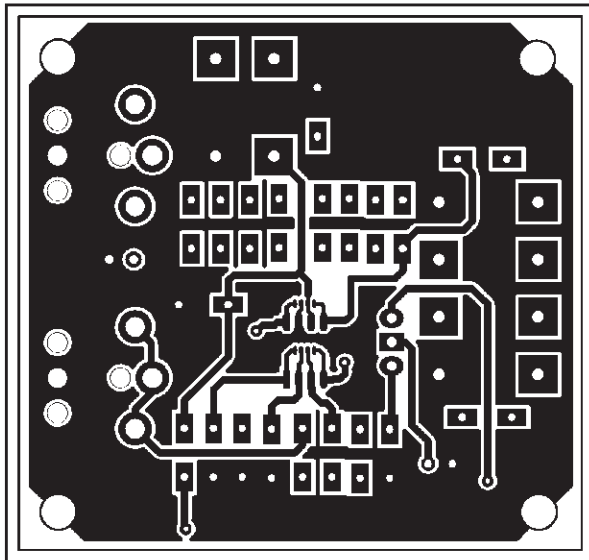


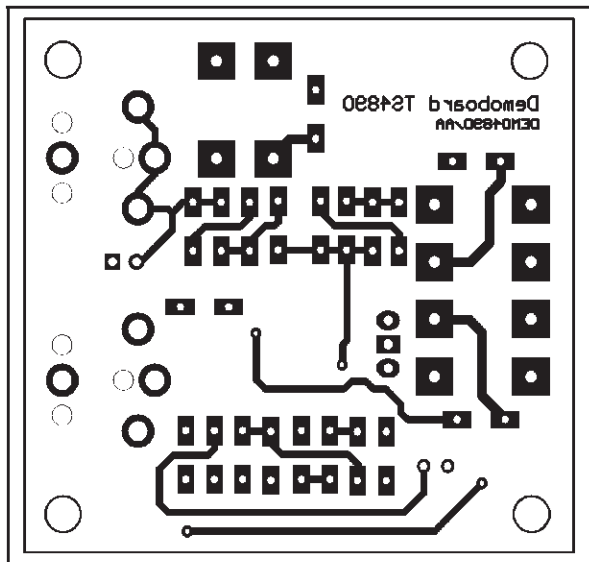
Fig. 102 : SO8 & MiniSO8 Demoboard Components Side



**Fig. 103 : SO8 & MiniSO8 Demoboard Top Solder Layer**



**Fig. 104 : SO8 & MiniSO8 Demoboard Bottom Solder Layer**



**■ BTL Configuration Principle**

The TS4890 is a monolithic power amplifier with a BTL output type. BTL (Bridge Tied Load) means that each end of the load are connected to two single ended output amplifiers. Thus, we have :

Single ended output 1 =  $V_{out1} = V_{out} (V)$   
 Single ended output 2 =  $V_{out2} = -V_{out} (V)$

And  $V_{out1} - V_{out2} = 2V_{out} (V)$

The output power is :

$$P_{out} = \frac{(2 V_{out_{RMS}})^2}{R_L} (W)$$

For the same power supply voltage, the output power in BTL configuration is four times higher than the output power in single ended configuration.

**■ Gain In Typical Application Schematic (cf. page 1)**

In flat region (no effect of  $C_{in}$ ), the output voltage of the first stage is :

$$V_{out1} = -V_{in} \frac{R_{feed}}{R_{in}} (V)$$

For the second stage :  $V_{out2} = -V_{out1} (V)$

The differential output voltage is

$$V_{out2} - V_{out1} = 2 V_{in} \frac{R_{feed}}{R_{in}} (V)$$

The differential gain named gain ( $G_v$ ) for more convenient usage is :

$$G_v = \frac{V_{out2} - V_{out1}}{V_{in}} = 2 \frac{R_{feed}}{R_{in}}$$

Remark :  $V_{out2}$  is in phase with  $V_{in}$  and  $V_{out1}$  is 180 phased with  $V_{in}$ . It means that the positive terminal of the loudspeaker should be connected to  $V_{out2}$  and the negative to  $V_{out1}$ .

**■ Low and high frequency response**

In low frequency region, the effect of  $C_{in}$  starts.  $C_{in}$  with  $R_{in}$  forms a high pass filter with a -3dB cut off frequency .

$$F_{CL} = \frac{1}{2\pi R_{in} C_{in}} (Hz)$$

In high frequency region, you can limit the bandwidth by adding a capacitor ( $C_{feed}$ ) in parallel on  $R_{feed}$ . Its form a low pass filter with a -3dB cut off frequency .

$$F_{CH} = \frac{1}{2\pi R_{feed} C_{feed}} (Hz)$$



■ **Power dissipation and efficiency**

Hypothesis :

- Voltage and current in the load are sinusoidal (V<sub>out</sub> and I<sub>out</sub>)
- Supply voltage is a pure DC source (V<sub>cc</sub>)

Regarding the load we have :

$$V_{OUT} = V_{PEAK} \sin \omega t \text{ (V)}$$

and

$$I_{OUT} = \frac{V_{OUT}}{R_L} \text{ (A)}$$

and

$$P_{OUT} = \frac{V_{PEAK}^2}{2R_L} \text{ (W)}$$

Then, the average current delivered by the supply voltage is

$$I_{CC_{AVG}} = 2 \frac{V_{PEAK}}{\pi R_L} \text{ (A)}$$

The power delivered by the supply voltage is  
P<sub>supply</sub> = V<sub>cc</sub> I<sub>CC<sub>AVG</sub></sub> (W)

Then, the **power dissipated by the amplifier** is  
P<sub>diss</sub> = P<sub>supply</sub> - P<sub>out</sub> (W)

$$P_{diss} = \frac{2\sqrt{2} V_{CC}}{\pi\sqrt{R_L}} \sqrt{P_{OUT}} - P_{OUT} \text{ (W)}$$

and the maximum value is obtained when

$$\frac{\partial P_{diss}}{\partial P_{OUT}} = 0$$

and its value is

$$P_{dissmax} = \frac{2 V_{CC}^2}{\pi^2 R_L} \text{ (W)}$$

Remark : This maximum value is only depending on power supply voltage and load values.

The **efficiency** is the ratio between the output power and the power supply

$$\eta = \frac{P_{OUT}}{P_{supply}} = \frac{\pi V_{PEAK}}{4 V_{CC}}$$

The maximum theoretical value is reached when V<sub>peak</sub> = V<sub>cc</sub>, so

$$\frac{\pi}{4} = 78.5\%$$

■ **Decoupling of the circuit**

Two capacitors are needed to bypass properly the TS4890. A power supply bypass capacitor C<sub>s</sub> and a bias voltage bypass capacitor C<sub>b</sub>.

**C<sub>s</sub>** has especially an influence on the THD+N in high frequency (above 7kHz) and indirectly on the power supply disturbances.

With 100μF, you can expect similar THD+N performances like shown in the datasheet.

If C<sub>s</sub> is lower than 100μF, in high frequency increase THD+N and disturbances on the power supply rail are less filtered.

To the contrary, if C<sub>s</sub> is higher than 100μF, those disturbances on the power supply rail are more filtered.

**C<sub>b</sub>** has an influence on THD+N in lower frequency, but its function is critical on the final result of PSRR with input grounded in lower frequency.

If C<sub>b</sub> is lower than 1μF, THD+N increase in lower frequency (see THD+N vs frequency curves) and the PSRR worsens up

If C<sub>b</sub> is higher than 1μF, the benefit on THD+N in lower frequency is small but the benefit on PSRR is substantial (see PSRR vs. C<sub>b</sub> curves).

Note that C<sub>in</sub> has a non-negligible effect on PSRR in lower frequency. Lower is its value, higher is the PSRR (see fig. 13).

■ **Pop and Click performance**

In order to have the best performances with the pop and click circuitry, the formula below must be follow :

$$\tau_{in} \leq \tau_b$$

With

$$\tau_{in} = (R_{in} + R_{feed}) \times C_{in} \text{ (s)}$$

and

$$\tau_b = 50k\Omega \times C_b \text{ (s)}$$

■ Power amplifier design examples

Given :

- Load impedance : 8Ω
- Output power @ 1% THD+N : 0.5W
- Input impedance : 10kΩ min.
- Input voltage peak to peak : 1Vpp
- Bandwidth frequency : 20Hz to 20kHz (0, -3dB)
- THD+N in 20Hz to 20kHz < 0.5% @Pout=0.45W
- Ambient temperature max = 50°C
- SO8 package

First of all, we must calculate the minimum power supply voltage to obtain 0.5W into 8Ω. See curves in fig. 15, we can read 3.5V. Thus, the power supply voltage value min. will be 3.5V.

Following the maximum power dissipation equation :

$$P_{diss\ max} = \frac{2V_{cc}^2}{\pi^2 R_L} \text{ (W)}$$

with 3.5V we have P<sub>dissmax</sub>=0.31W.

Refer to power derating curves (fig. 24), with 0.31W the maximum ambient temperature will be 100°C. This last value could be higher if you follow the example layout shows on the demoboard (better dissipation).

The gain of the amplifier in flat region will be :

$$G_V = \frac{V_{OUTPP}}{V_{INPP}} = \frac{2\sqrt{2R_L P_{OUT}}}{V_{INPP}} = 5.65$$

We have Rin > 10kΩ. Let's take Rin = 10kΩ, then R<sub>feed</sub> = 28.25kΩ. We could use for R<sub>feed</sub> = 30kΩ in normalized value and the gain will be G<sub>v</sub> = 6.

In lower frequency we want 20 Hz (-3dB cut off frequency). Then

$$C_{IN} = \frac{1}{2\pi R_{in} F_{CL}} = 795nF$$

So, we could use for C<sub>in</sub> a 1μF capacitor value that gives 16Hz.

In Higher frequency we want 20kHz (-3dB cut off frequency). The Gain Bandwidth Product of the TS4890 is 2MHz typical and doesn't change when the amplifier delivers power into the load.

The first amplifier has a gain of

$$\frac{R_{feed}}{R_{in}} = 3$$

and the theoretical value of the -3dB cut of higher frequency is 2MHz/3 = 660kHz.

We can keep this value or limiting the bandwidth by adding a capacitor C<sub>feed</sub>, in parallel on R<sub>feed</sub>. Then

$$C_{FEED} = \frac{1}{2\pi R_{FEED} F_{CH}} = 265pF$$

So, we could use for C<sub>feed</sub> a 220pF capacitor value that gives 24kHz.

Now, we can choose the value of C<sub>b</sub> with the constraint THD+N in 20Hz to 20kHz < 0.5% @ Pout=0.45W. If you refer to the closest THD+N vs frequency measurement : fig. 71 (V<sub>cc</sub>=3.3V, G<sub>v</sub>=10), with C<sub>b</sub> = 1μF, the THD+N vs frequency is always below 0.4%. As the behaviour is the same with V<sub>cc</sub> = 5V (fig. 67), V<sub>cc</sub> = 2.6V (fig. 67). As the gain for these measurements is higher (worst case), we can consider with C<sub>b</sub> = 1μF, V<sub>cc</sub> = 3.5V and G<sub>v</sub> = 6, that the THD+N in 20Hz to 20kHz range with Pout = 0.45W will be lower than 0.4%.

In the following tables, you could find three another examples with values required for the demoboard.

Remark : components with (\*) marking are optional.

**Application n°1 : 20Hz to 20kHz bandwidth and 6dB gain BTL power amplifier.**

**Components :**

Designator	Part Type
R1	22k / 0.125W
R4	22k / 0.125W
R6	Short Circuit
R7*	(V <sub>cc</sub> -V <sub>f_led</sub> )/I <sub>f_led</sub>
R8	10k / 0.125W
C5	470nF
C6	100μF

Designator	Part Type
C7	100nF
C9	Short Circuit
C10	Short Circuit
C12	1μF
S1, S2, S6, S7	2mm insulated Plug 10.16mm pitch
S8	3 pts connector 2.54mm pitch
P1	PCB Phono Jack
D1*	Led 3mm
U1	TS4890ID or TS4890IS

**Application n°2 : 20Hz to 20kHz bandwidth and 20dB gain BTL power amplifier.**

**Components :**

Designator	Part Type
R1	110k / 0.125W
R4	22k / 0.125W
R6	Short Circuit
R7*	(Vcc-Vf_led)/If_led
R8	10k / 0.125W
C5	470nF
C6	100μF
C7	100nF
C9	Short Circuit
C10	Short Circuit
C12	1μF
S1, S2, S6, S7	2mm insulated Plug 10.16mm pitch
S8	3 pts connector 2.54mm pitch
P1	PCB Phono Jack
D1*	Led 3mm
U1	TS4890ID or TS4890IS

**Application n°3 : 50Hz to 10kHz bandwidth and 10dB gain BTL power amplifier.**

**Components :**

Designator	Part Type
R1	33k / 0.125W
R2	Short Circuit
R4	22k / 0.125W
R6	Short Circuit
R7*	(Vcc-Vf_led)/If_led
R8	10k / 0.125W
C2	470pF
C5	150nF
C6	100μF
C7	100nF
C9	Short Circuit
C10	Short Circuit
C12	1μF
S1, S2, S6, S7	2mm insulated Plug 10.16mm pitch
S8	3 pts connector 2.54mm pitch
P1	PCB Phono Jack
D1*	Led 3mm
U1	TS4890ID or TS4890IS

**Application n°4 : Differential inputs BTL power amplifier.**

In this configuration, we need to place these components : R1, R4, R5, R6, R7, C4, C5, C12.

We have also : R4 = R5, R1 = R6, C4 = C5.

The gain of the amplifier is :

$$G_{VDIFF} = 2 \frac{R1}{R4} (\text{Pos. Input} - \text{Neg. Input})$$

For a 20Hz to 20kHz bandwidth and 6dB gain BTL power amplifier you could follow the bill of material below.

## TS4890

### Components :

Designator	Part Type
R1	22k / 0.125W
R4	22k / 0.125W
R5	22k / 0.125W
R6	22k / 0.125W
R7*	$(V_{cc}-V_{f\_led})/I_{f\_led}$
R8	10k / 0.125W
C4	470nF
C5	470nF
C6	100 $\mu$ F
C7	100nF
C9	Short Circuit
C10	Short Circuit
C12	1 $\mu$ F
D1*	Led 3mm
S1, S2, S6, S7	2mm insulated Plug 10.16mm pitch
S8	3 pts connector 2.54mm pitch
P1, P2	PCB Phono Jack
U1	TS4890ID or TS4890IS

### ■ Note on how to use the PSRR curves (page 8)

We have finished a design and we have chosen for the components :

- $R_{in}=R_{feed}=22k\Omega$
- $C_{in}=100nF$
- $C_b=1\mu F$

Now, on fig. 16, we can see the PSRR (input grounded) vs frequency curves. At 217Hz, we have a PSRR value of -36dB.

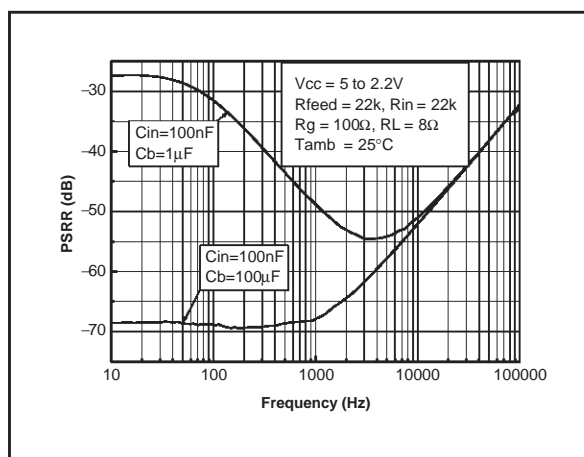
In reality we want a value about -70dB. So, we need a gain of 34dB !

Now, on fig. 15 we can see the effect of  $C_b$  on the PSRR (input grounded) vs. frequency. With  $C_b=100\mu F$ , we can reach the -70dB value.

The process to obtain the final curve ( $C_b=100\mu F$ ,  $C_{in}=100nF$ ,  $R_{in}=R_{feed}=22k\Omega$ ) is a simple transfer point by point on each frequency of the curve on fig. 16 to the curve on fig. 15.

The measurement result is shown on the next figure.

**Fig. 105 : PSRR changes with  $C_b$**



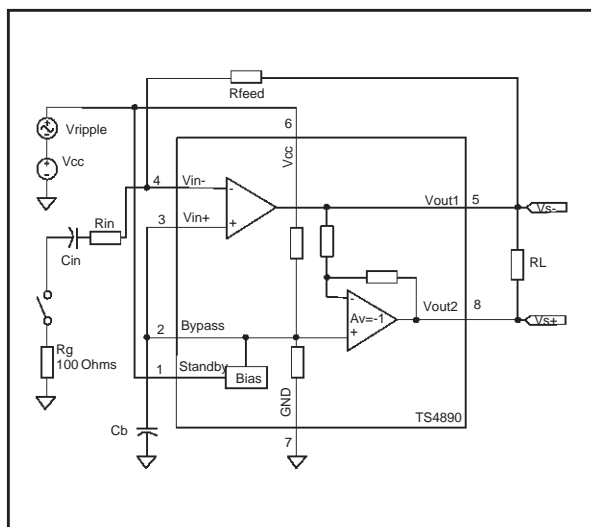
■ Note on PSRR measurement

*What is the PSRR ?*

The PSRR is the Power Supply Rejection Ratio. It's a kind of SVR in a determined frequency range. The PSRR of a device, is the ratio between a power supply disturbance and the result on the output. We can say that the PSRR is the ability of a device to minimize the impact of power supply disturbances to the output.

*How we measure the PSRR ?*

**Fig. 106 : PSRR measurement schematic**



■ Principle of operation

- We fixed the DC voltage supply (Vcc)
- We fixed the AC sinusoidal ripple voltage (Vripple)
- No bypass capacitor Cs is used

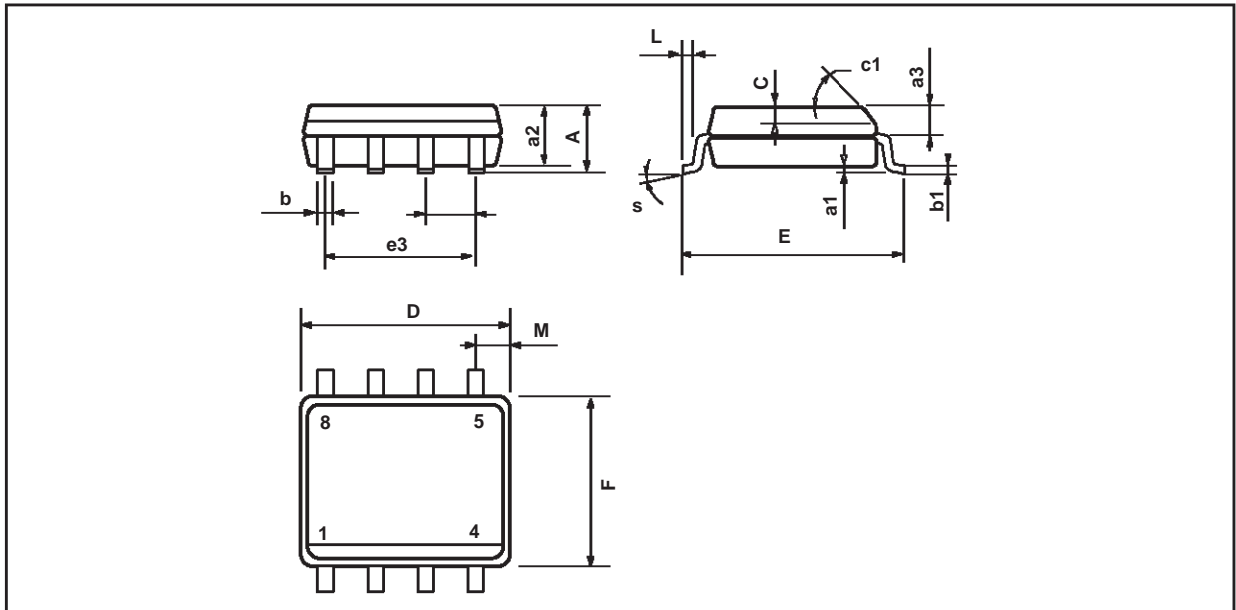
The PSRR value for each frequency is :

$$PSRR(dB) = 20 \times \text{Log}_{10} \left[ \frac{\text{Rms}(V_{\text{ripple}})}{\text{Rms}(V_{s+} - V_{s-})} \right]$$

Remark : The measure of the Rms voltage is not a Rms selective measure but a full range (2 Hz to 125 kHz) Rms measure. It means that we measure the effective Rms signal + the noise.

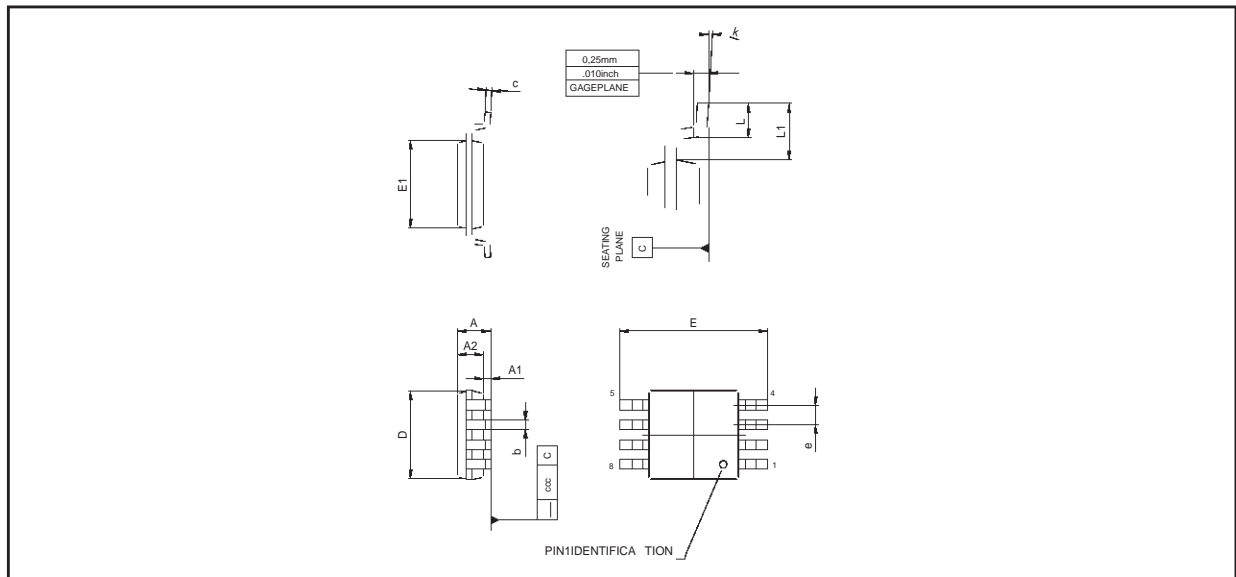
## TS4890

### PACKAGE MECHANICAL DATA 8 PINS - PLASTIC MICROPACKAGE (SO)



Dim.	Millimeters			Inches		
	Min.	Typ.	Max.	Min.	Typ.	Max.
A			1.75			0.069
a1	0.1		0.25	0.004		0.010
a2			1.65			0.065
a3	0.65		0.85	0.026		0.033
b	0.35		0.48	0.014		0.019
b1	0.19		0.25	0.007		0.010
C	0.25		0.5	0.010		0.020
c1	45° (typ.)					
D	4.8		5.0	0.189		0.197
E	5.8		6.2	0.228		0.244
e		1.27			0.050	
e3		3.81			0.150	
F	3.8		4.0	0.150		0.157
L	0.4		1.27	0.016		0.050
M			0.6			0.024
S	8° (max.)					

**PACKAGE MECHANICAL DATA**  
**8 PINS - PLASTIC MICROPACKAGE (miniSO)**



Dim.	Millimeters			Inches		
	Min.	Typ.	Max.	Min.	Typ.	Max.
A			1.100			0.043
A1	0.050	0.100	0.150	0.002	0.004	0.006
A2	0.780	0.860	0.940	0.031	0.034	0.037
b	0.250	0.330	0.400	0.010	0.013	0.016
c	0.130	0.180	0.230	0.005	0.007	0.009
D	2.900	3.000	3.100	0.114	0.118	0.122
E	4.750	4.900	5.050	0.187	0.193	0.199
E1	2.900	3.000	3.100	0.114	0.118	0.122
e		0.650			0.026	
L	0.400	0.550	0.700	0.016	0.022	0.028
L1		0.950			0.037	
k	0d	3d	6d	0d	3d	6d
aaa			0.100			0.004

Information furnished is believed to be accurate and reliable. However, STMicroelectronics assumes no responsibility for the consequences of use of such information nor for any infringement of patents or other rights of third parties which may result from its use. No license is granted by implication or otherwise under any patent or patent rights of STMicroelectronics. Specifications mentioned in this publication are subject to change without notice. This publication supersedes and replaces all information previously supplied. STMicroelectronics products are not authorized for use as critical components in life support devices or systems without express written approval of STMicroelectronics.

© The ST logo is a registered trademark of STMicroelectronics

© 2001 STMicroelectronics - Printed in Italy - All Rights Reserved  
 STMicroelectronics GROUP OF COMPANIES

Australia - Brazil - Canada - China - Finland - France - Germany - Hong Kong - India - Israel - Italy - Japan - Malaysia  
 Malta - Morocco - Singapore - Spain - Sweden - Switzerland - United Kingdom - United States

© <http://www.st.com>

