

NCP2890

1.0 Watt Audio Power Amplifier

The NCP2890 is an audio power amplifier designed for portable communication device applications such as mobile phone applications. The NCP2890 is capable of delivering 1.0 W of continuous average power to an 8.0 Ω load from a 5.0 V power supply, and 320 mW to a 4.0 Ω load from a 2.6 V power supply.

The NCP2890 provides high quality audio while requiring few external components and minimal power consumption. It features a low-power consumption shutdown mode, which is achieved by driving the SHUTDOWN pin with logic low.

The NCP2890 contains circuitry to prevent from “pop and click” noise that would otherwise occur during turn-on and turn-off transitions.

For maximum flexibility, the NCP2890 provides an externally controlled gain (with resistors), as well as an externally controlled turn-on and turn-off times (with the bypass capacitor).

Due to its excellent PSRR, it can be directly connected to the battery, saving the use of an LDO.

This device is available in Microbump-9 and Micro8 package.

Features

- 1.0 W to an 8.0 Ω Load from a 5.0 V Power Supply
- Excellent PSRR: Direct Connection to the Battery
- « Pop and Click » Noise Protection Circuit
- Ultra Low Current Shutdown Mode
- 2.2 V-5.5 V Operation
- External Gain Configuration Capability
- External Turn-on and Turn-off Time Configuration Capability
- Up to 1.0 nF Capacitive Load Driving Capability
- Thermal Overload Protection Circuitry

Typical Applications

- Portable Electronic Devices
- PDAs
- Wireless Phones



ON Semiconductor®

<http://onsemi.com>

MARKING DIAGRAMS



Microbump-9
FC SUFFIX
CASE 499E



A1

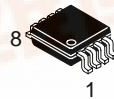

Micro8™
DM SUFFIX
CASE 846A

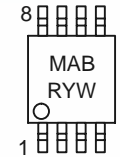

1

R = Assembly Location
YY, Y = Year
WW, W = Work Week

PIN CONNECTIONS

Microbump-9

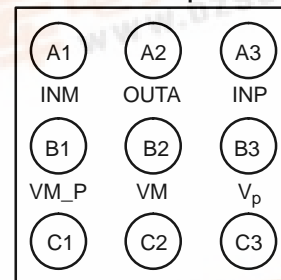

BYPASS OUTB SHUTDOWN
(Top View)

Micro8

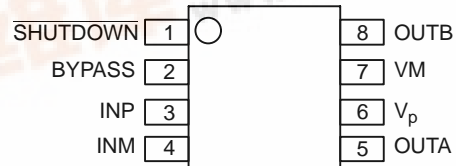

(Top View)

ORDERING INFORMATION

Device	Package	Shipping
NCP2890FCT1	Microbump-9	3000/ Tape & Reel
NCP2890DMR2	Micro8	4000/ Tape & Reel



NCP2890

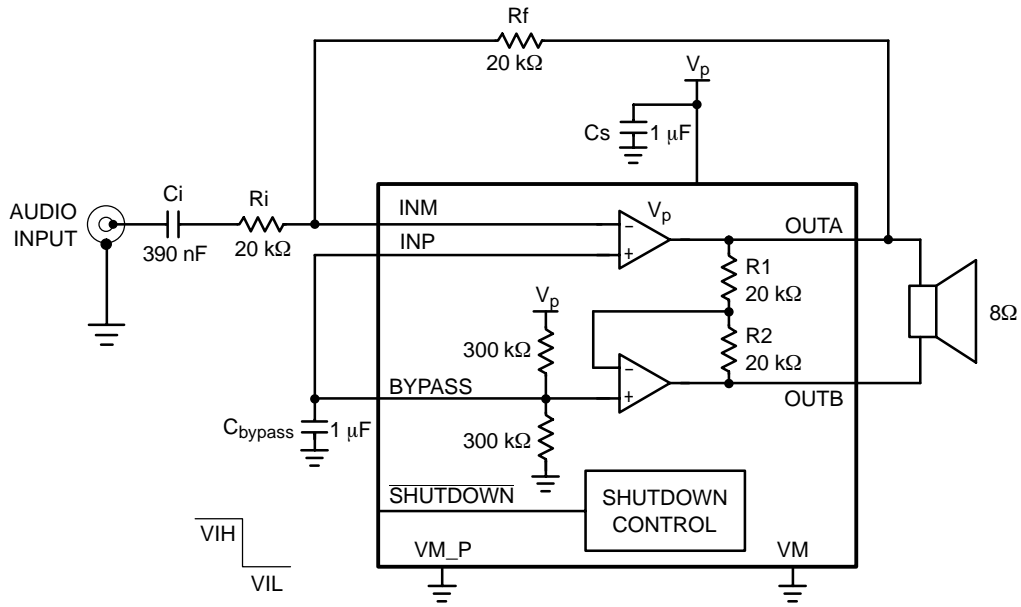

Figure 1. Typical Audio Amplifier Application Circuit with Single Ended Input

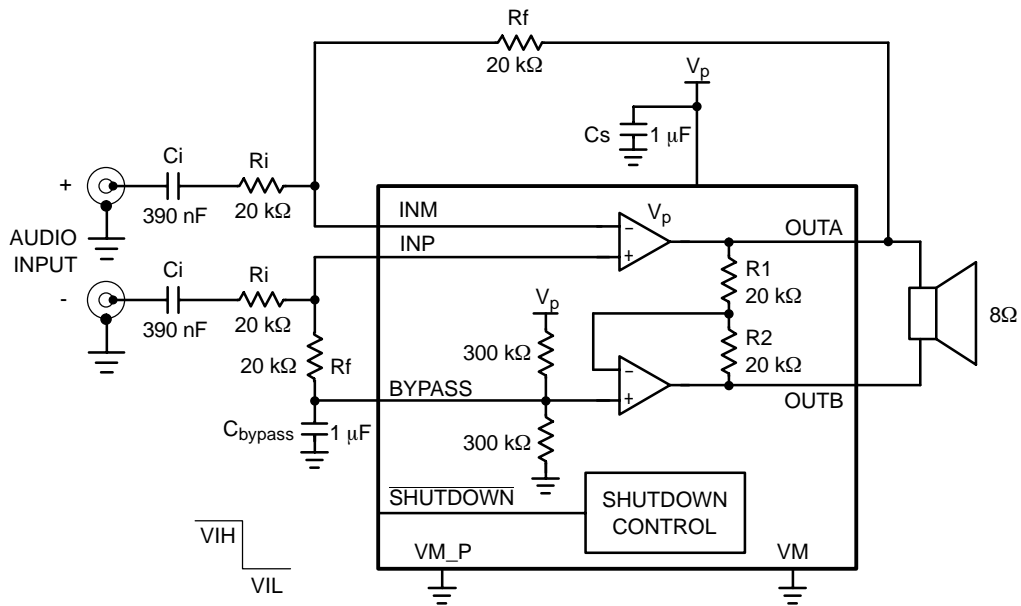

Figure 2. Typical Audio Amplifier Application Circuit with a Differential Input

This device contains 671 active transistors and 1899 MOS gates.

NCP2890

PIN DESCRIPTION

Microbump-9	Micro8	Type	Symbol	Description
A1	4	I	INM	Negative input of the first amplifier, receives the audio input signal. Connected to the feedback resistor R _f and to the input resistor R _{in} .
A2	5	O	OUTA	Negative output of the NCP2890. Connected to the load and to the feedback resistor R _f .
A3	3	I	INP	Positive input of the first amplifier, receives the common mode voltage.
B1	NA	I	VM_P	Power Analog Ground.
B2	7	I	VM	Core Analog Ground.
B3	6	I	V _p	Positive analog supply of the cell. Range: 2.5 V-5.5 V.
C1	2	I	BYPASS	Bypass capacitor pin which provides the common mode voltage (V _p /2).
C2	8	O	OUTB	Positive output of the NCP2890. Connected to the load.
C3	1	I	SHUTDOWN	The device enters in shutdown mode when a low level is applied on this pin.

MAXIMUM RATINGS (Note 1)

Rating	Symbol	Value	Unit
Supply Voltage	V _p	6.0	V
Operating Supply Voltage	Op V _p	2.2 to 5.5 V 2.0 V = Functional Only	-
Input Voltage	V _{in}	-0.3 to V _{cc} +0.3	V
Max Output Current	I _{out}	500	mA
Power Dissipation (Note 2)	P _d	Internally Limited	-
Operating Ambient Temperature	T _A	-40 to +85	°C
Max Junction Temperature	T _J	150	°C
Storage Temperature Range	T _{stg}	-65 to +150	°C
Thermal Resistance Junction-to-Air	R _{θJA}	230 (Note 3)	°C/W
ESD Protection	Human Body Model (HBM) (Note 4) Machine Model (MM) (Note 5)	- >2500 >250	V

- Maximum electrical ratings are defined as those values beyond which damage to the device may occur at T_A = +25°C.
- The thermal shutdown set to 160°C (typical) avoids irreversible damage on the device due to power dissipation. For further information see page 10.
- For the Microbump-9 package, the R_{θJA} is highly dependent of the PCB Heatsink area. For example, R_{θJA} can equal 195°C/W with 50 mm² total area and also 135°C/W with 500 mm². For further information see page 10. The bumps have the same thermal resistance and all need to be connected to optimize the power dissipation.
- Human Body Model, 100 pF discharge through a 1.5 kΩ resistor following specification JESD22/A114.
- Machine Model, 200 pF discharged through all pins following specification JESD22/A115.

NCP2890

ELECTRICAL CHARACTERISTICS Limits apply for T_A between -40°C to $+85^{\circ}\text{C}$ (Unless otherwise noted).

Characteristic	Symbol	Conditions	Min (Note 6)	Typ	Max (Note 6)	Unit
Supply Quiescent Current	I_{dd}	$V_p = 2.6\text{ V}$, No Load	-	1.5	4	mA
		$V_p = 5.0\text{ V}$, No Load	-	1.7		
		$V_p = 2.6\text{ V}$, $8\ \Omega$	-	1.7	5.5	
		$V_p = 5.0\text{ V}$, $8\ \Omega$	-	1.9		
Common Mode Voltage	V_{cm}	-	-	$V_p/2$	-	V
Shutdown Current	I_{SD}	-	-	10	600	nA
Shutdown Voltage High	V_{SDIH}	-	1.2	-	-	V
Shutdown Voltage Low	V_{SDIL}	-	-	-	0.4	V
Turning On Time (Note 8)	T_{WU}	$C_{by} = 1\ \mu\text{F}$	-	285	-	ms
Turning Off Time (Note 8)	T_{SD}	$C_{by} = 1\ \mu\text{F}$ and $V_p = 5.0\text{ V}$	-	385	-	ms
Output Swing	$V_{loadpeak}$	$V_p = 2.6\text{ V}$, $R_L = 8.0\ \Omega$	1.6	2.12	-	V
		$V_p = 5.0\text{ V}$, $R_L = 8.0\ \Omega$ (Note 7)	4.0	4.15	-	
Rms Output Power	P_O	$V_p = 2.6\text{ V}$, $R_L = 4.0\ \Omega$ THD + N < 0.1%	-	0.36	-	W
		$V_p = 2.6\text{ V}$, $R_L = 8.0\ \Omega$ THD + N < 0.1%	-	0.28	-	
		$V_p = 5.0\text{ V}$, $R_L = 8.0\ \Omega$ THD + N < 0.1%	-	1.08	-	
Maximum Power Dissipation (Note 8)	P_{Dmax}	$V_p = 5.0\text{ V}$, $R_L = 8.0\ \Omega$	-	-	0.65	W
Output Offset Voltage	V_{OS}	$V_p = 2.6\text{ V}$ $V_p = 5.0\text{ V}$	-30		30	mV
Signal-to-Noise Ratio	SNR	$V_p = 2.6\text{ V}$, $G = 2.0$ $10\text{ Hz} < F < 20\text{ kHz}$	-	84	-	dB
		$V_p = 5.0\text{ V}$, $G = 10$ $10\text{ Hz} < F < 20\text{ kHz}$	-	77	-	
Positive Supply Rejection Ratio	PSRR V_+	$G = 2.0$, $R_L = 8.0\ \Omega$ $V_{Pripple_pp} = 200\text{ mV}$ $C_{by} = 1.0\ \mu\text{F}$ Input Terminated with $10\ \Omega$				dB
		$F = 217\text{ Hz}$ $V_p = 5.0\text{ V}$	-	64	-	
		$V_p = 3.0\text{ V}$	-	72	-	
		$V_p = 2.6\text{ V}$	-	73	-	
		$F = 1.0\text{ kHz}$ $V_p = 5.0\text{ V}$	-	64	-	
		$V_p = 3.0\text{ V}$	-	74	-	
		$V_p = 2.6\text{ V}$	-	75	-	
Efficiency	η	$V_p = 2.6\text{ V}$, $P_{orms} = 320\text{ mW}$	-	48	-	%
		$V_p = 5.0\text{ V}$, $P_{orms} = 1.0\text{ W}$	-	63	-	
Thermal Shutdown Temperature (Note 9)	T_{sd}		140	160	180	$^{\circ}\text{C}$
Total Harmonic Distortion	THD	$V_p = 2.6$, $F = 1.0\text{ kHz}$ $R_L = 4.0\ \Omega$, $A_V = 2.0$ $P_O = 0.32\text{ W}$	-	-	-	%
			-	0.04	-	
			-	-	-	
		$V_p = 5.0\text{ V}$, $F = 1.0\text{ kHz}$ $R_L = 8.0\ \Omega$, $A_V = 2.0$ $P_O = 1.0\text{ W}$	-	-	-	
			-	0.02	-	
			-	-	-	

6. Min/Max limits are guaranteed by design, test or statistical analysis.

7. This parameter is not tested in production for Microbump-9 package in case of a 5.0 V power supply.

8. See page 11 for a theoretical approach of these parameters.

9. For this parameter, the Min/Max values are given for information.

NCP2890

Typical Performance Characteristics

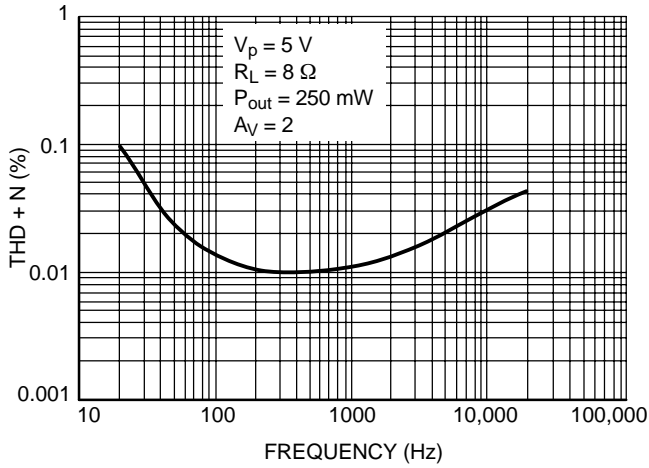

Figure 1. THD + N versus Frequency

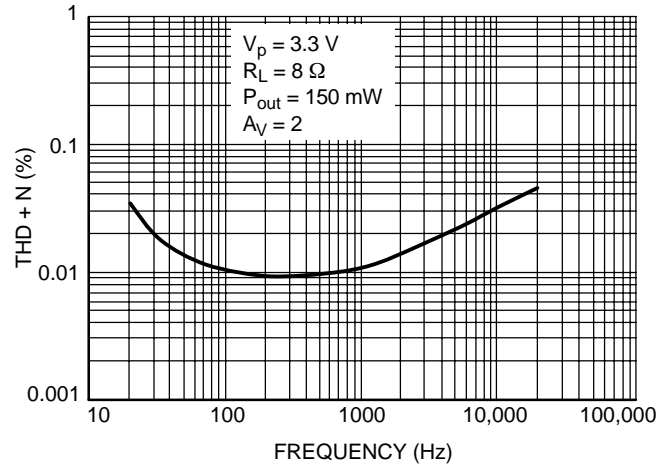

Figure 2. THD + N versus Frequency

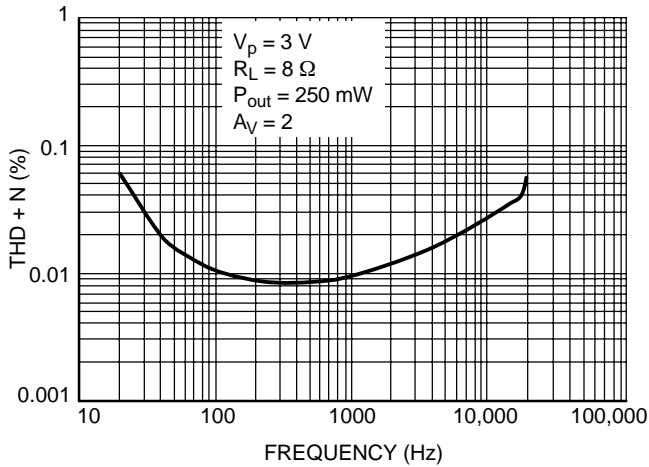

Figure 3. THD + N versus Frequency

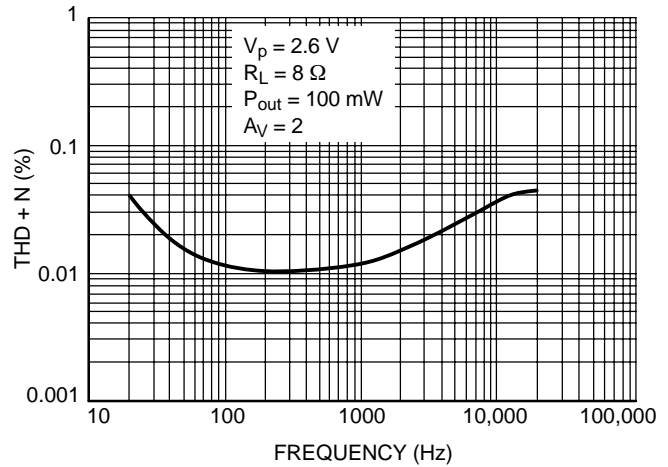

Figure 4. THD + N versus Frequency

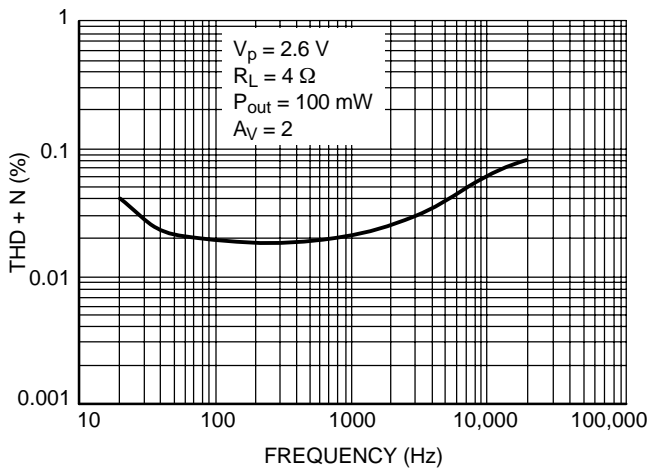

Figure 5. THD + N versus Frequency

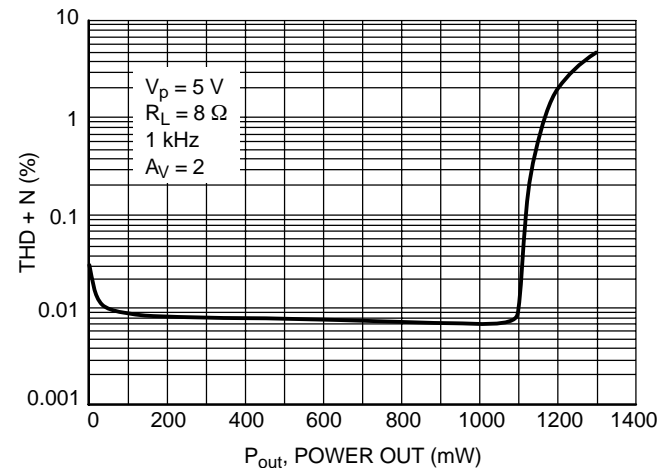

Figure 6. THD + N versus Power Out

NCP2890

Typical Performance Characteristics

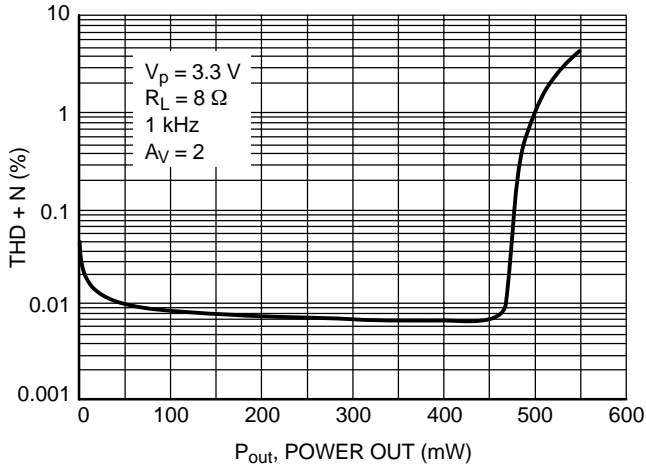

Figure 7. THD + N versus Power Out

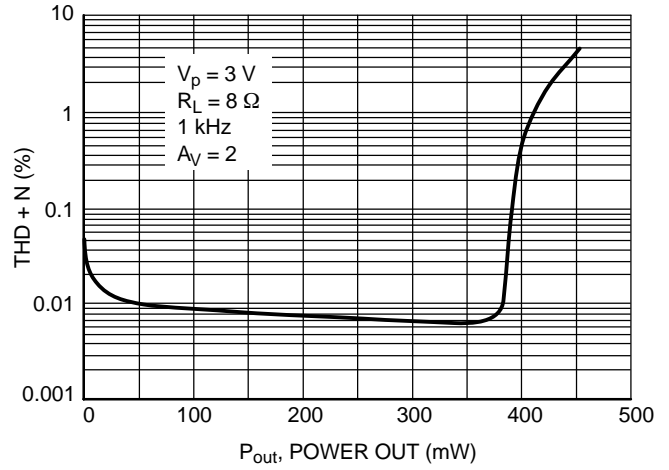

Figure 8. THD + N versus Power Out

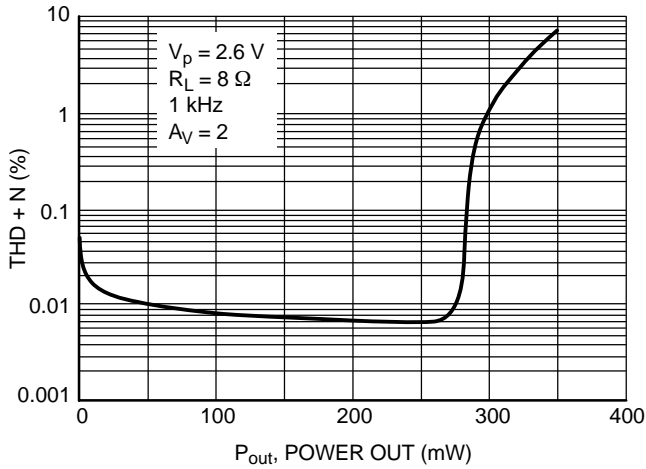

Figure 9. THD + N versus Power Out

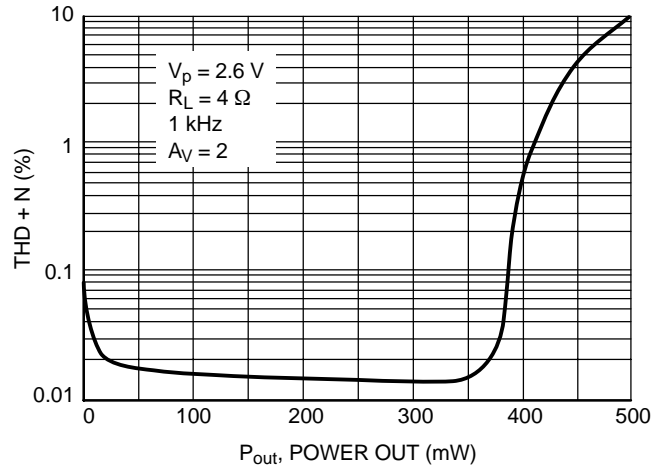

Figure 10. THD + N versus Power Out

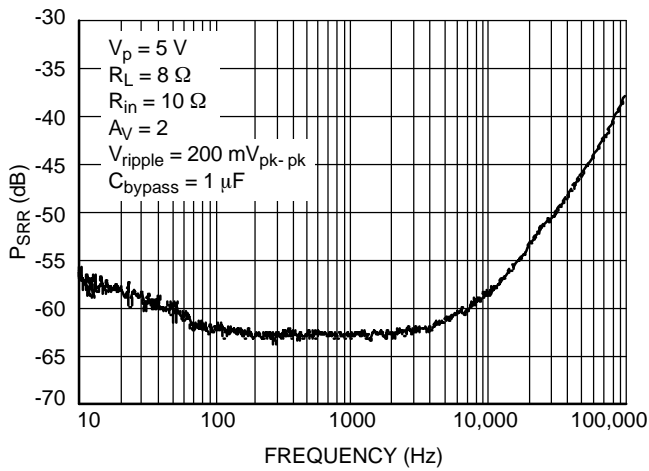

Figure 11. P_{SRR} @ $V_p = 5 \text{ V}$

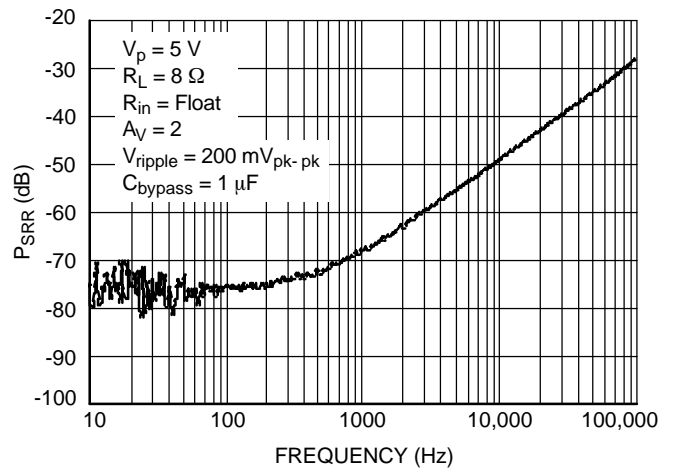

Figure 12. P_{SRR} @ $V_p = 5 \text{ V}$

NCP2890

Typical Performance Characteristics

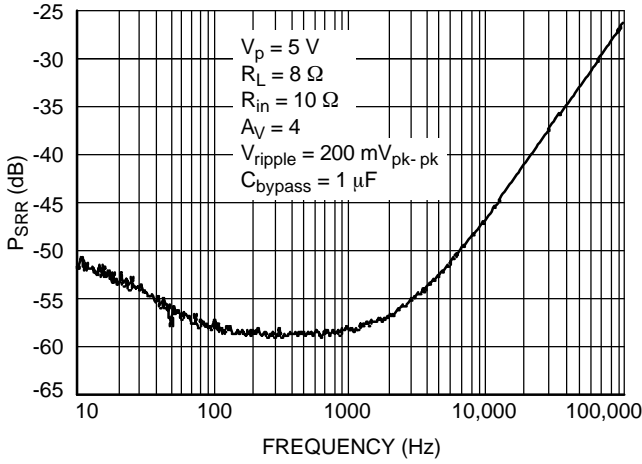

Figure 13. P_{SRR} @ V_p = 5 V

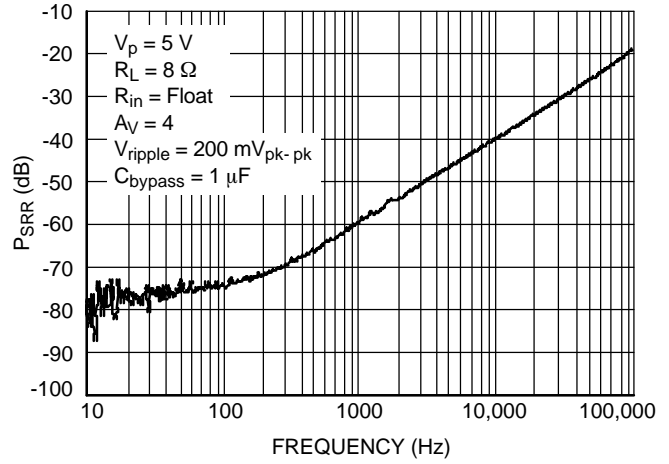

Figure 14. P_{SRR} @ V_p = 5 V

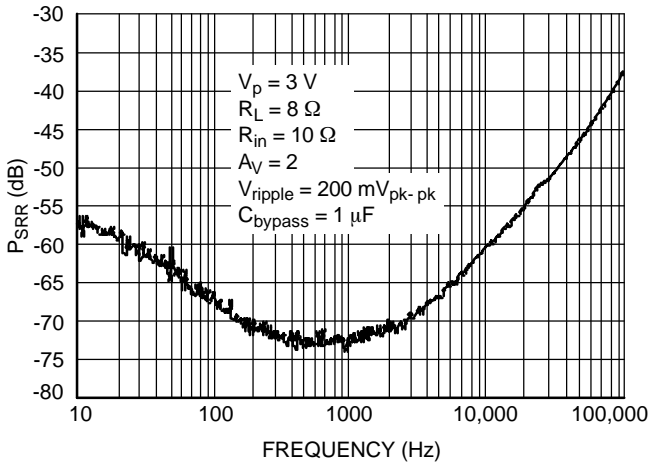

Figure 15. P_{SRR} @ V_p = 3 V

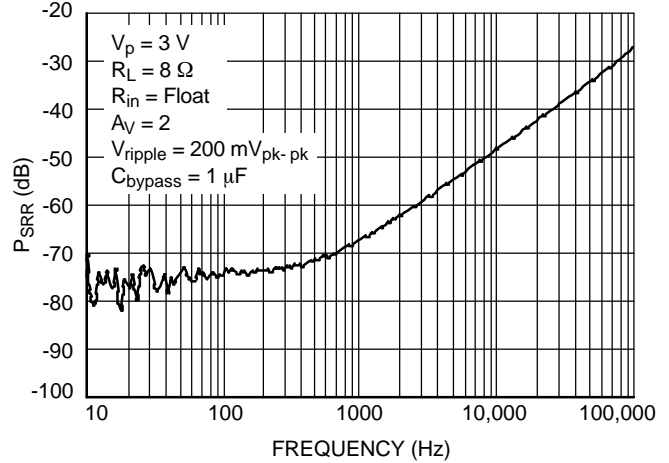

Figure 16. P_{SRR} @ V_p = 3 V

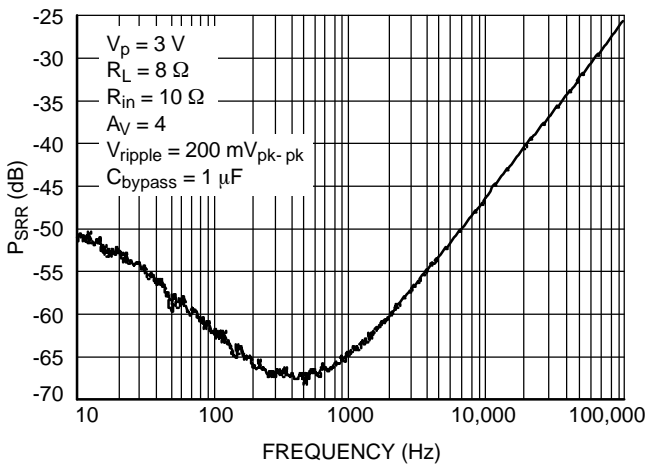

Figure 17. P_{SRR} @ V_p = 3 V

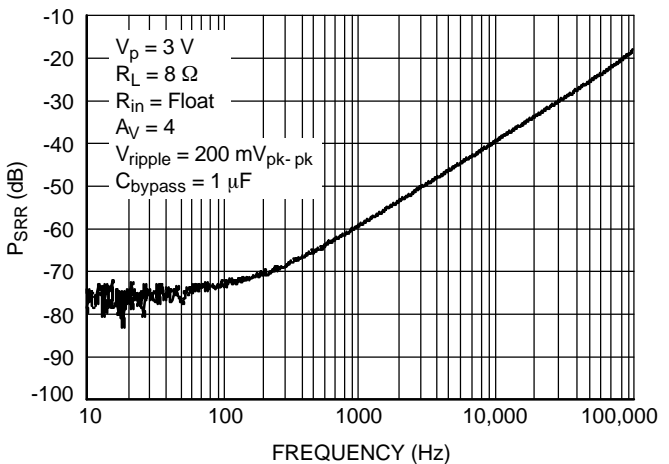

Figure 18. P_{SRR} @ V_p = 3 V

NCP2890

Typical Performance Characteristics

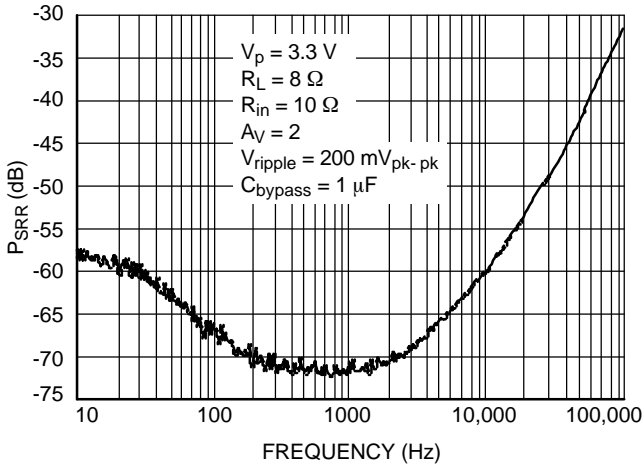

Figure 19. P_{SRR} @ $V_p = 3.3$ V

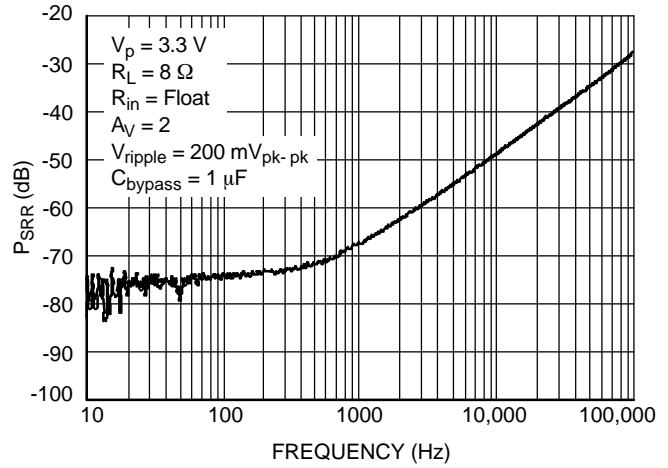

Figure 20. P_{SRR} @ $V_p = 3.3$ V

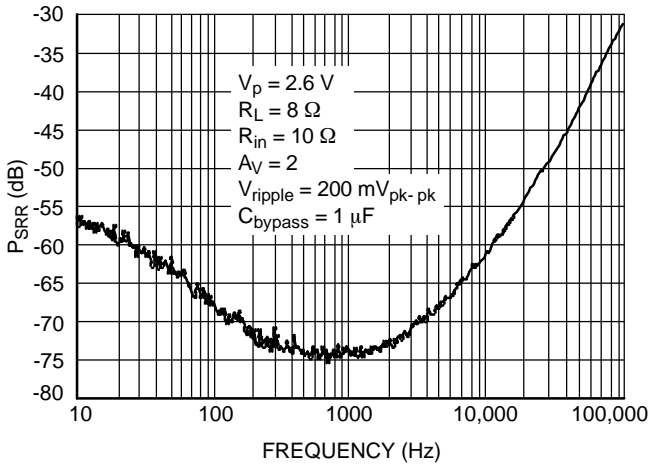

Figure 21. P_{SRR} @ $V_p = 2.6$ V

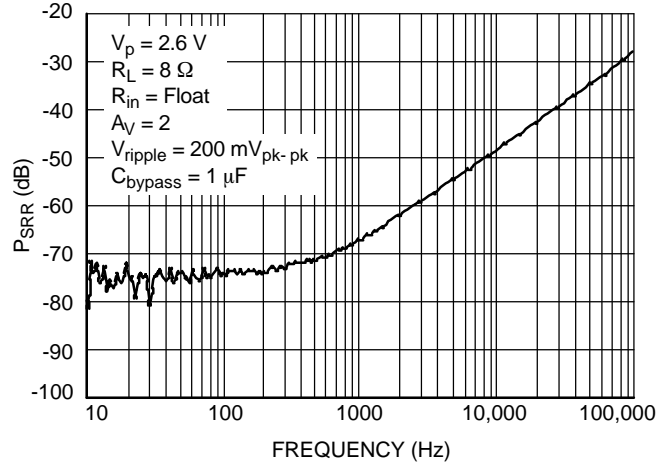

Figure 22. P_{SRR} @ $V_p = 2.6$ V

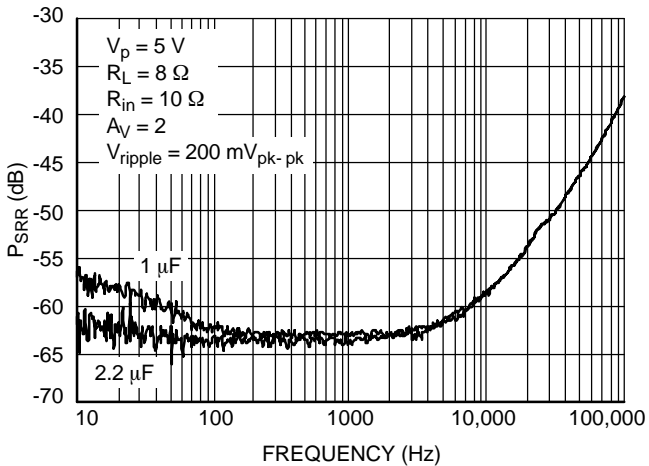

Figure 23. P_{SRR} versus C_{bypass} @ $V_p = 5$ V

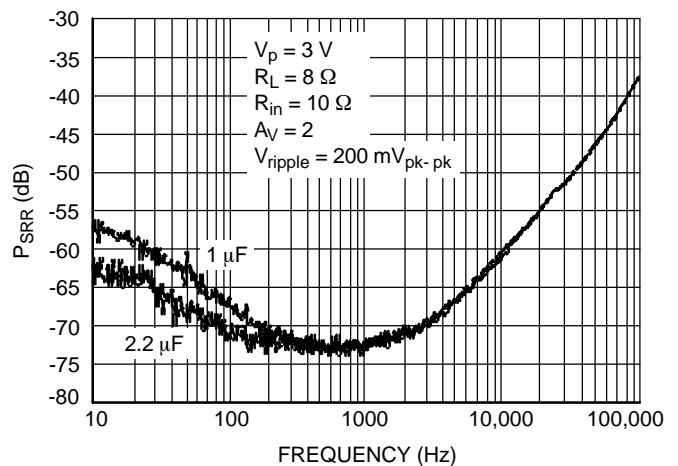

Figure 24. P_{SRR} versus C_{bypass} @ $V_p = 3$ V

NCP2890

Typical Performance Characteristics

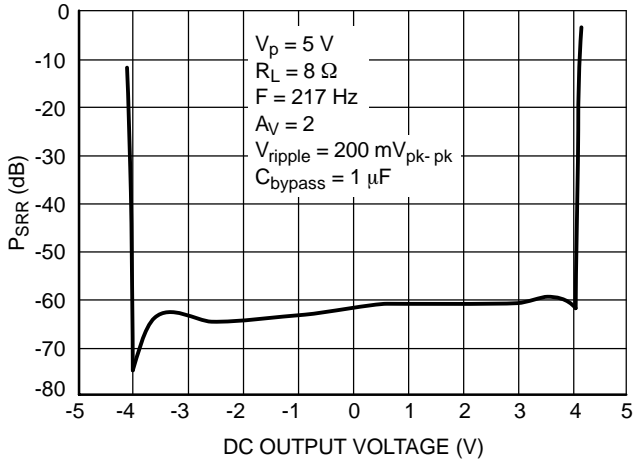

Figure 25. P_{SRR} @ DC Output Voltage

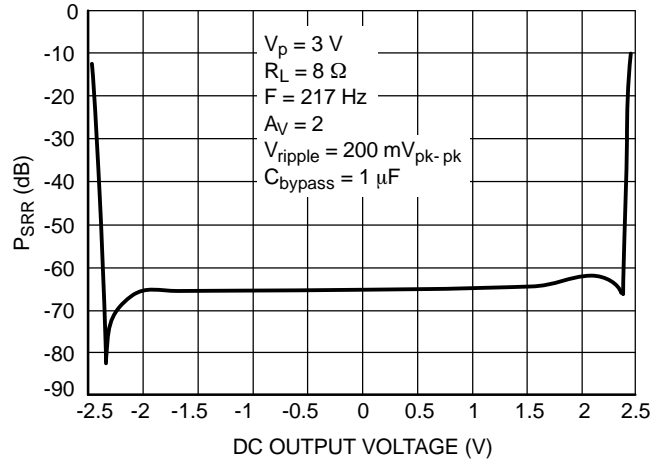

Figure 26. P_{SRR} @ DC Output Voltage

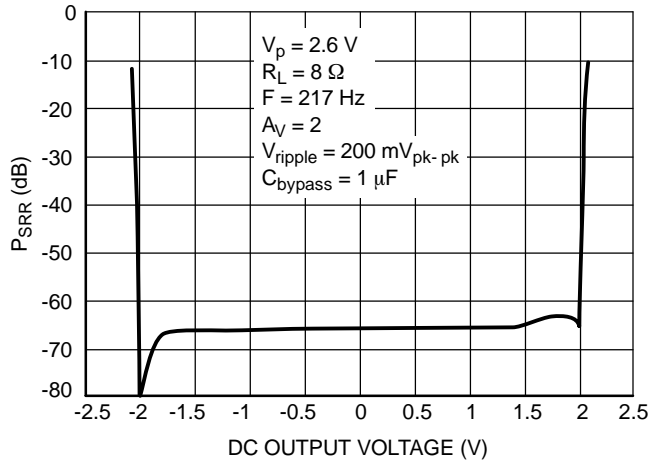

Figure 27. P_{SRR} @ DC Output Voltage

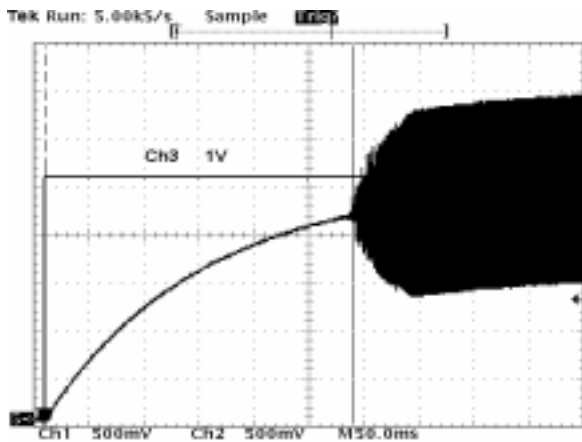

Figure 28. Turning On Time - $V_D = 5\text{ V}$

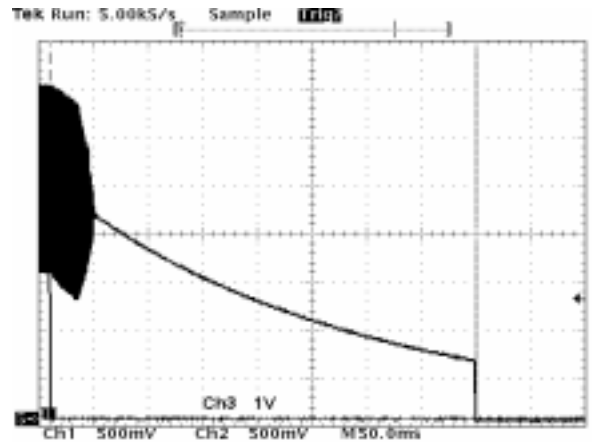

Figure 29. Turning Off Time - $V_D = 5\text{ V}$

NCP2890

Typical Performance Characteristics

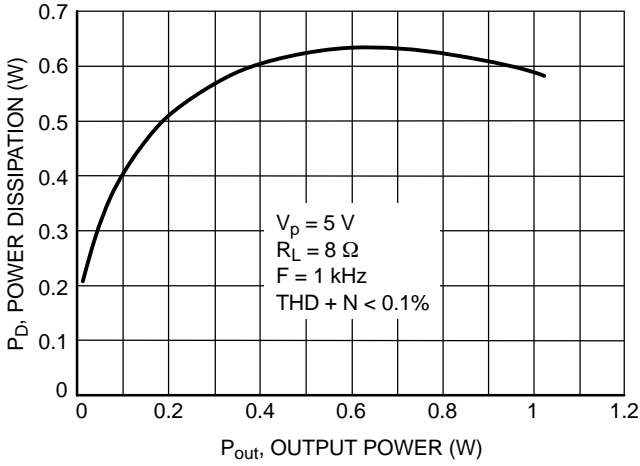

Figure 30. Power Dissipation versus Output Power

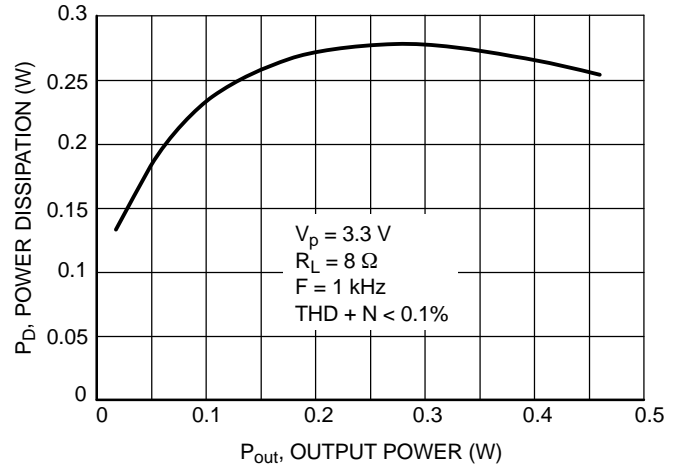

Figure 31. Power Dissipation versus Output Power

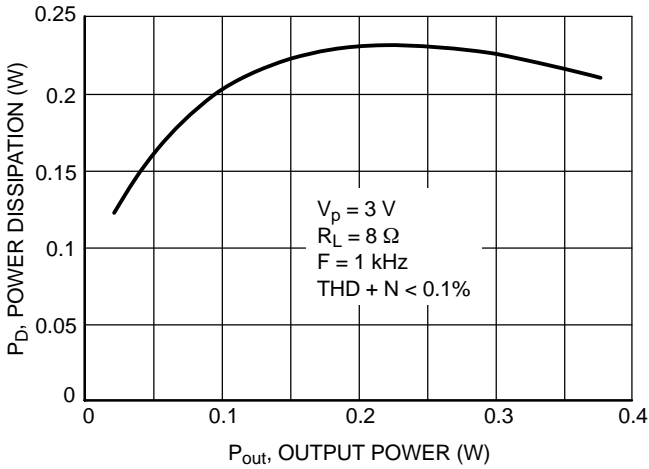

Figure 32. Power Dissipation versus Output Power

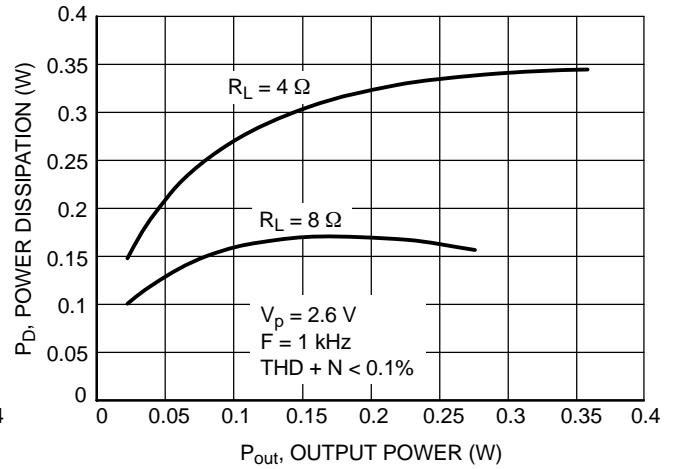

Figure 33. Power Dissipation versus Output Power

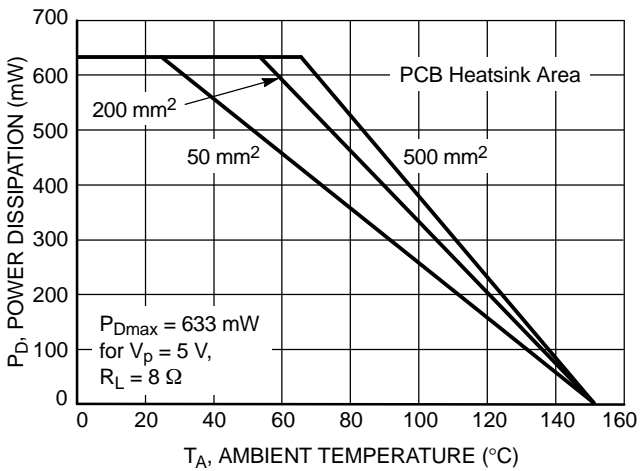

Figure 34. Power Derating - Microbump-9

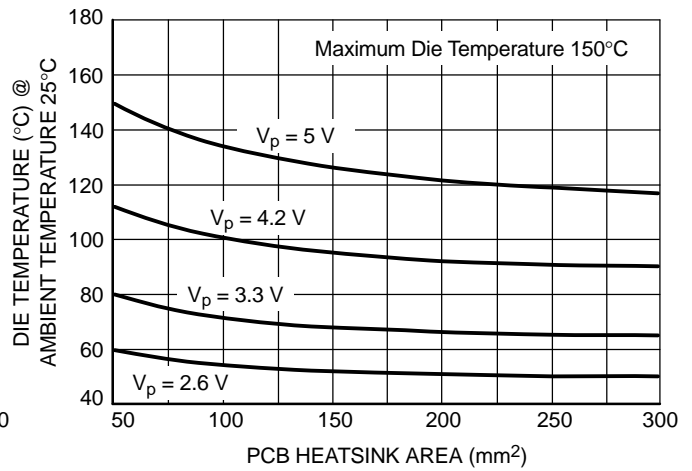

Figure 35. Maximum Die Temperature versus PCB Heatsink Area

NCP2890

APPLICATION INFORMATION

Detailed Description

The NCP2890 audio amplifier can operate under 2.6 V until 5.5 V power supply. It delivers 320 mW rms output power to 4.0 Ω load ($V_p = 2.6$ V) and 1.0 W rms output power to 8.0 Ω load ($V_p = 5.0$ V).

The structure of the NCP2890 is basically composed of two identical internal power amplifiers; the first one is externally configurable with gain-setting resistors R_{in} and R_f (the closed-loop gain is fixed by the ratios of these resistors) and the second is internally fixed in an inverting unity-gain configuration by two resistors of 20 k Ω . So the load is driven differentially through OUTA and OUTB outputs. This configuration eliminates the need for an output coupling capacitor.

Internal Power Amplifier

The output Pmos and Nmos transistors of the amplifier were designed to deliver the output power of the specifications without clipping. The channel resistance (R_{on}) of the Nmos and Pmos transistors does not exceed 0.6 Ω when they drive current.

The structure of the internal power amplifier is composed of three symmetrical gain stages, first and medium gain stages are transconductance gain stages to obtain maximum bandwidth and DC gain.

Turn-On and Turn-Off Transitions

A cycle with a turn-on and turn-off transition is illustrated with plots that show both single ended signals on the previous page.

In order to eliminate « pop and click » noises during transitions, output power in the load must be slowly established or cut. When logic high is applied to the shutdown pin, the bypass voltage begins to rise exponentially and once the output DC level is around the common mode voltage, the gain is established slowly (50 ms). This way to turn-on the device is optimized in terms of rejection of « pop and click » noises.

The device has the same behavior when it is turned-off by a logic low on the shutdown pin. During the shutdown mode, amplifier outputs are connected to the ground.

A theoretical value of turn-on and off times at 25°C is given by the following formula.

C_{by} : bypass capacitor

R: internal 300 k resistor with a 25% accuracy

$$T_{on} = 0.95 * R * C_{by}$$

$$T_{off} = R * C_{by} * \ln(V_p/1.4)$$

Shutdown Function

The device enters shutdown mode when shutdown signal is low. During the shutdown mode, the DC quiescent current of the circuit does not exceed 100 nA.

Current Limit Circuit

The maximum output power of the circuit ($P_{orms} = 1.0$ W, $V_p = 5.0$ V, $R_L = 8.0$ Ω) requires a peak current in the load of 500 mA.

In order to limit the excessive power dissipation in the load when a short-circuit occurs, the current limit in the load is fixed to 800 mA. The current in the four output MOS transistors are real-time controlled, and when one current exceeds 800 mA, the gate voltage of the MOS transistor is clipped and no more current can be delivered.

Thermal Overload Protection

Internal amplifiers are switched off when the temperature exceeds 160°C, and will be switched on again only when the temperature decreases fewer than 140°C.

The NCP2890 is unity-gain stable and requires no external components besides gain-setting resistors, an input coupling capacitor and a proper bypassing capacitor in the typical application.

The first amplifier is externally configurable (R_f and R_{in}), while the second is fixed in an inverting unity gain configuration.

The differential-ended amplifier presents two major advantages:

- The possible output power is four times larger (the output swing is doubled) as compared to a single-ended amplifier under the same conditions.
- Output pins (OUTA and OUTB) are biased at the same potential $V_p/2$, this eliminates the need for an output coupling capacitor required with a single-ended amplifier configuration.

The differential closed loop-gain of the amplifier is given by $A_{vd} = 2 * \frac{R_f}{R_{in}} = \frac{V_{orms}}{V_{inrms}}$.

Output power delivered to the load is given by $P_{orms} = \frac{(V_{opeak})^2}{2 * R_L}$ (V_{opeak} is the peak differential output voltage).

When choosing gain configuration to obtain the desired output power, check that the amplifier is not current limited or clipped.

The maximum current which can be delivered to the load is 500 mA $I_{opeak} = \frac{V_{opeak}}{R_L}$.

Gain-Setting Resistor Selection (R_{in} and R_f)

R_{in} and R_f set the closed-loop gain of the amplifier.

In order to optimize device and system performance, the NCP2890 should be used in low gain configurations.

The low gain configuration minimizes THD + noise values and maximizes the signal to noise ratio, and the

NCP2890

amplifier can still be used without running into the bandwidth limitations.

A closed loop gain in the range from 2 to 5 is recommended to optimize overall system performance.

An input resistor (R_{in}) value of 22 K Ω is realistic in most of applications, and doesn't require the use of a too large capacitor C_{in} .

Input Capacitor Selection (C_{in})

The input coupling capacitor blocks the DC voltage at the amplifier input terminal. This capacitor creates a high-pass filter with R_{in} , the cut-off frequency is given by

$$f_c = \frac{1}{2 * \Pi * R_{in} * C_{in}}$$

The size of the capacitor must be large enough to couple in low frequencies without severe attenuation. However a

large input coupling capacitor requires more time to reach its quiescent DC voltage ($V_p/2$) and can increase the turn-on pops.

An input capacitor value between 0.1 μ and 0.39 μ F performs well in many applications (With $R_{in} = 22$ K Ω).

Bypass Capacitor Selection (C_{by})

The bypass capacitor C_{by} provides half-supply filtering and determines how fast the NCP2890 turns on.

This capacitor is a critical component to minimize the turn-on pop. A 1.0 μ F bypass capacitor value ($C_{in} = < 0.39$ μ F) should produce clickless and popless shutdown transitions. The amplifier is still functional with a 0.1 μ F capacitor value but is more susceptible to « pop and click » noises.

Thus, a 1.0 μ F bypassing capacitor is recommended.

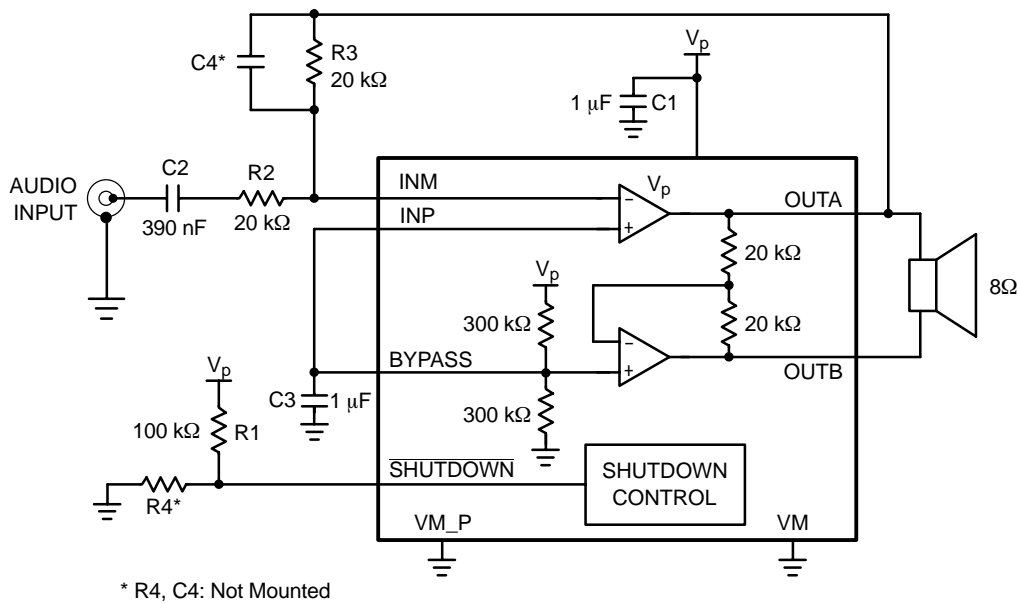
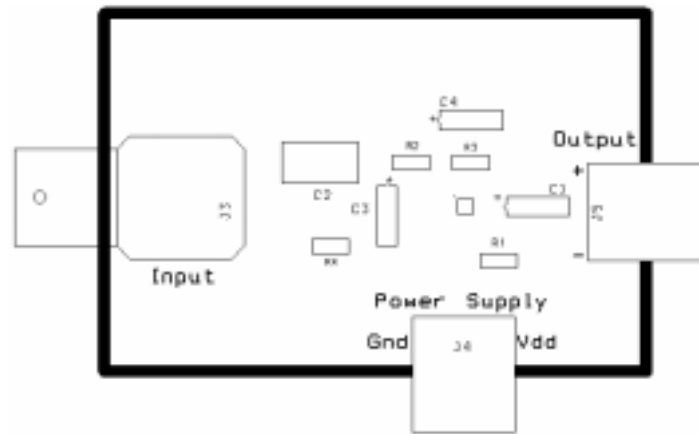
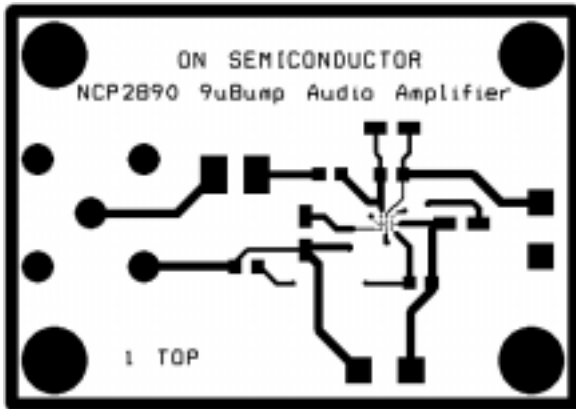

Figure 36. Schematic of the Demonstration Board of the Microbump-9 Device

NCP2890



Silkscreen Layer



Top Layer

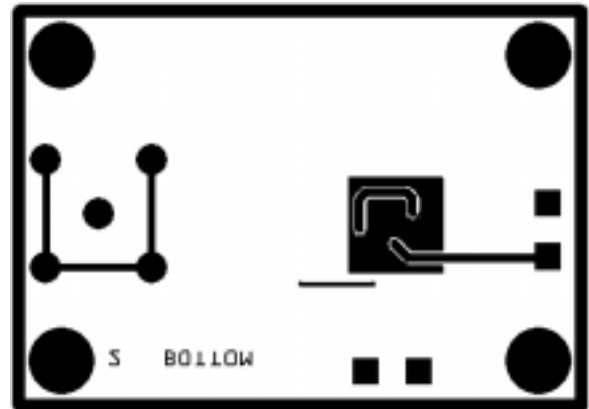

Bottom Layer

Figure 37. Demonstration Board for Microbump-9 Device - PCB Layers

NCP2890

BILL OF MATERIAL

Item	Part Description	Ref.	PCB Footprint	Manufacturer	Manufacturer Reference
1	NCP2890 Audio Amplifier	-	-	ON Semiconductor	NCP2890
2	SMD Resistor 100 K Ω	R1	0805	Vishay-Draloric	D12CRCW Series
3	SMD Resistor 20 K Ω	R2, R3	0805	Vishay-Draloric	CRCW0805 Series
4	Ceramic Capacitor 1.0 μ F 16 V X7R	C1	1206	Murata	GRM42-6X7R105K16
5	Ceramic Capacitor 390 nF 50 V Z5U	C2	1812	Kemet	C1812C394M5UAC
6	Ceramic Capacitor 1.0 μ F 16 V X7R	C3	1206	Murata	GRM42-6X7R105K16
7	Not Mounted	R4, C4	-	-	-
8	BNC Connector	J3	-	Telegartner	JO1001A1948
9	I/O Connector. It can be plugged by BLZ5.08/2 (Weidmüller Reference)	J4, J5	-	Weidmüller	SL5.08/2/90B

NCP2890

PACKAGE DIMENSIONS

Microbump-9
FC SUFFIX
CASE 499E-01
ISSUE O

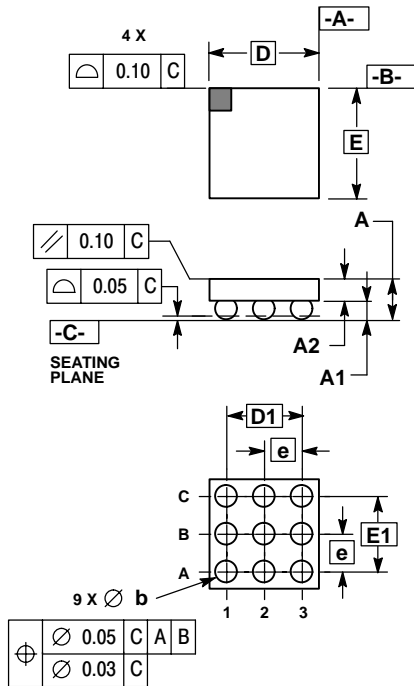

- NOTES:
- DIMENSIONING AND TOLERANCING PER ANSI Y14.5M, 1982.
 - CONTROLLING DIMENSION: MILLIMETERS.
 - COPLANARITY APPLIES TO SPHERICAL CROWNS OF SOLDER BALLS.

DIM	MILLIMETERS	
	MIN	MAX
A	0.540	0.660
A1	0.210	0.270
A2	0.330	0.390
D	1.450 BSC	
E	1.450 BSC	
b	0.290	0.340
e	0.500 BSC	
D1	1.000 BSC	
E1	1.000 BSC	

RECOMMENDED PCB FOOTPRINT

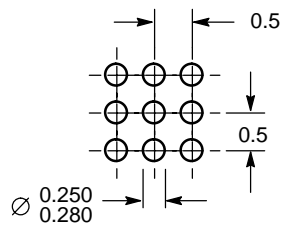

NCP2890

PACKAGE DIMENSIONS

Micro8
DM SUFFIX
CASE 846A-02
ISSUE F

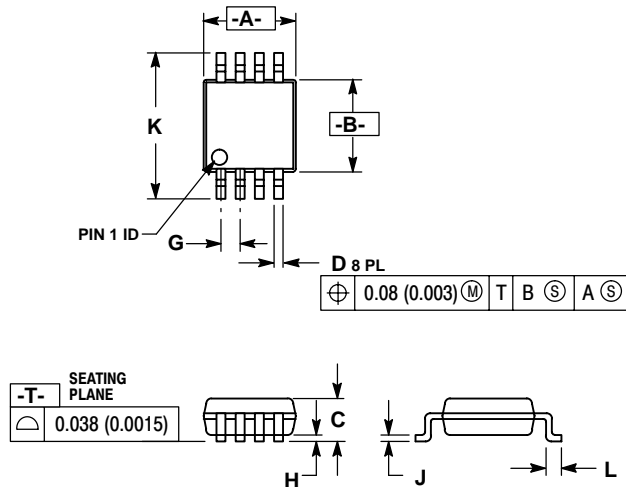

NOTES:

1. DIMENSIONING AND TOLERANCING PER ANSI Y14.5M, 1982.
2. CONTROLLING DIMENSION: MILLIMETER.
3. DIMENSION A DOES NOT INCLUDE MOLD FLASH, PROTRUSIONS OR GATE BURRS. MOLD FLASH, PROTRUSIONS OR GATE BURRS SHALL NOT EXCEED 0.15 (0.006) PER SIDE.
4. DIMENSION B DOES NOT INCLUDE INTERLEAD FLASH OR PROTRUSION. INTERLEAD FLASH OR PROTRUSION SHALL NOT EXCEED 0.25 (0.010) PER SIDE.
5. 846A-01 OBSOLETE, NEW STANDARD 846A-02.

MILLIMETERS		INCHES		
DIM	MIN	MAX	MIN	MAX
A	2.90	3.10	0.114	0.122
B	2.90	3.10	0.114	0.122
C	---	1.10	---	0.043
D	0.25	0.40	0.010	0.016
G	0.65 BSC		0.026 BSC	
H	0.05	0.15	0.002	0.006
J	0.13	0.23	0.005	0.009
K	4.75	5.05	0.187	0.199
L	0.40	0.70	0.016	0.028

Micro8 is a trademark of International Rectifier.

ON Semiconductor and  are registered trademarks of Semiconductor Components Industries, LLC (SCILLC). SCILLC reserves the right to make changes without further notice to any products herein. SCILLC makes no warranty, representation or guarantee regarding the suitability of its products for any particular purpose, nor does SCILLC assume any liability arising out of the application or use of any product or circuit, and specifically disclaims any and all liability, including without limitation special, consequential or incidental damages. "Typical" parameters which may be provided in SCILLC data sheets and/or specifications can and do vary in different applications and actual performance may vary over time. All operating parameters, including "Typicals" must be validated for each customer application by customer's technical experts. SCILLC does not convey any license under its patent rights nor the rights of others. SCILLC products are not designed, intended, or authorized for use as components in systems intended for surgical implant into the body, or other applications intended to support or sustain life, or for any other application in which the failure of the SCILLC product could create a situation where personal injury or death may occur. Should Buyer purchase or use SCILLC products for any such unintended or unauthorized application, Buyer shall indemnify and hold SCILLC and its officers, employees, subsidiaries, affiliates, and distributors harmless against all claims, costs, damages, and expenses, and reasonable attorney fees arising out of, directly or indirectly, any claim of personal injury or death associated with such unintended or unauthorized use, even if such claim alleges that SCILLC was negligent regarding the design or manufacture of the part. SCILLC is an Equal Opportunity/Affirmative Action Employer.

PUBLICATION ORDERING INFORMATION

Literature Fulfillment:

Literature Distribution Center for ON Semiconductor
P.O. Box 5163, Denver, Colorado 80217 USA
Phone: 303-675-2175 or 800-344-3860 Toll Free USA/Canada
Fax: 303-675-2176 or 800-344-3867 Toll Free USA/Canada
Email: ONlit@hibbertco.com

N. American Technical Support: 800-282-9855 Toll Free USA/Canada

JAPAN: ON Semiconductor, Japan Customer Focus Center
2-9-1 Kamimeguro, Meguro-ku, Tokyo, Japan 153-0051
Phone: 81-3-5773-3850
Email: r14525@onsemi.com

ON Semiconductor Website: <http://onsemi.com>

For additional information, please contact your local Sales Representative.