

Integrated Silicon Pressure Sensor On-Chip Signal Conditioned, Temperature Compensated and Calibrated

The MPX4080D series piezoresistive transducer is a state-of-the-art monolithic silicon pressure sensor designed for a wide range of applications, but particularly those employing a microcontroller or microprocessor with A/D inputs. This patented, single element transducer combines advanced micromachining techniques, thin-film metallization, and bipolar processing to provide an accurate, high level analog output signal that is proportional to the applied pressure.

Features

- 3.0% Maximum Error over 0° to 85°C
- Ideally suited for Microprocessor or Microcontroller-Based Systems
- Temperature Compensated from -40° to 105°C
- Easy-to-Use, Durable Epoxy Unibody Package

Figure 1 shows a block diagram of the internal circuitry integrated on the pressure sensor chip.

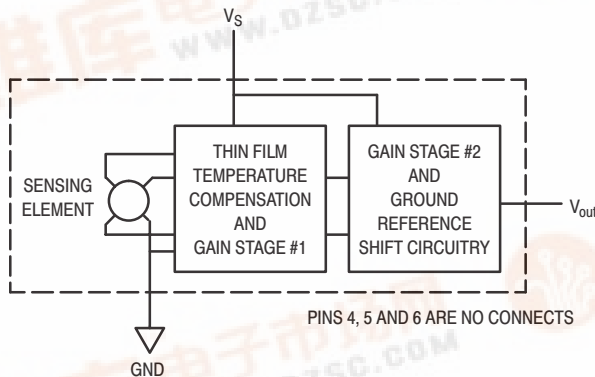
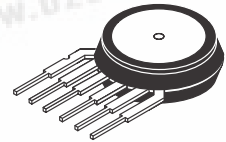

Figure 1. Fully Integrated Pressure Sensor Schematic

MPX4080D

**INTEGRATED PRESSURE
 SENSOR**
 0 to 80 kPa (0 to 11.6 psi)
 0.58 to 4.9 Volts Output

UNIBODY PACKAGE



**MPX4080D
 CASE 867**

NOTE: Pin 1 is the notched pin.

PIN NUMBER			
1	V_{out}	4	N/C
2	Gnd	5	N/C
3	V_S	6	N/C

NOTE: Pins 4, 5, and 6 are internal device connections. Do not connect to external circuitry or ground. Pin 1 is noted by the notch in the lead.

MPX4080D

MAXIMUM RATINGS(NOTE)

Parametrics	Symbol	Value	Unit
Maximum Pressure (P1 > P2) (P2 > P1)	P _{max}	400 400	kPa
Storage Temperature	T _{stg}	-40° to +125°	°C

NOTE: Exposure beyond the specified limits may cause permanent damage or degradation to the device.

OPERATING CHARACTERISTICS (V_S = 5.1 Vdc, T_A = 25°C unless otherwise noted, P1 > P2. Decoupling circuit shown in Figure 4 required to meet electrical specifications.)

Characteristic	Symbol	Min	Typ	Max	Unit
Pressure Range ⁽¹⁾	P _{OP}	0	—	80	kPa
Supply Voltage ⁽²⁾	V _S	4.85	5.1	5.35	Vdc
Supply Current	I _o	—	7.0	10	mAdc
Minimum Pressure Offset ⁽³⁾ @ V _S = 5.1 Volts (0 to 85°C)	V _{off}	0.478	0.575	0.672	Vdc
Full Scale Output ⁽⁴⁾ @ V _S = 5.1 Volts (0 to 85°C)	V _{FSSO}	4.772	4.900	5.020	Vdc
Full Scale Span ⁽⁵⁾ @ V _S = 5.1 Volts (0 to 85°C)	V _{FSS}	—	4.325	—	Vdc
Accuracy ⁽⁶⁾	—	—	—	± 3.0	%V _{FSS}
Sensitivity	V/P	—	54	—	mV/kPa

NOTES:

1. 1.0kPa (kiloPascal) equals 0.145 psi.
2. Device is ratiometric within this specified excitation range.
3. Offset (V_{off}) is defined as the output voltage at the minimum rated pressure.
4. Full Scale Output (V_{FSSO}) is defined as the output voltage at the maximum or full rated pressure.
5. Full Scale Span (V_{FSS}) is defined as the algebraic difference between the output voltage at full rated pressure and the output voltage at the minimum rated pressure.
6. Accuracy (error budget) consists of the following:
 - Linearity: Output deviation from a straight line relationship with pressure over the specified pressure range.
 - Temperature Hysteresis: Output deviation at any temperature within the operating temperature range, after the temperature is cycled to and from the minimum or maximum operating temperature points, with zero differential pressure applied.
 - Pressure Hysteresis: Output deviation at any pressure within the specified range, when this pressure is cycled to and from minimum or maximum rated pressure at 25°C.
 - TcSpan: Output deviation over the temperature range of 0° to 85°C, relative to 25°C.
 - TcOffset: Output deviation with minimum pressure applied, over the temperature range of 0° to 85°C, relative to 25°C.
 - Variation from Nominal: The variation from nominal values, for Offset or Full Scale Span, as a percent of V_{FSS} at 25°C.

ON-CHIP TEMPERATURE COMPENSATION, CALIBRATION and SIGNAL CONDITIONING

Figure 2 shows the sensor output signal relative to differential pressure input. Typical, minimum, and maximum output curves are shown for operation over a temperature range of 0° to 85°C using the decoupling circuit shown in Figure 4. The output will saturate outside of the specified pressure range.

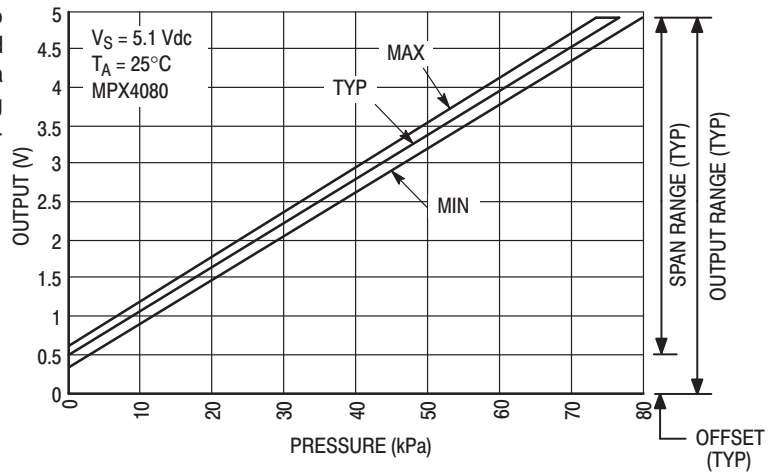

Figure 2. Output versus Pressure Differential

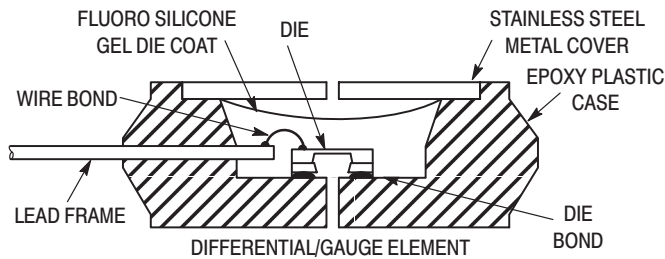

Figure 3. Cross-Sectional Diagrams (Not to Scale)

Figure 3 illustrates the differential sensing chip in the basic chip carrier (Case 867). A fluorosilicone gel isolates the die surface and wire bonds from the environment, while allowing the pressure signal to be transmitted to the sensor diaphragm.

The MPX4080D pressure sensor operating characteristics, internal reliability, and qualification tests are based on use of dry air as the pressure media. Media, other

than dry air, may have adverse effects on sensor performance and long-term reliability. Contact the factory for information regarding media compatibility in your application.

Figure 4 shows the recommended decoupling circuit for interfacing the output of the integrated sensor to the A/D input of a microprocessor or microcontroller. Proper decoupling of the power supply is recommended.

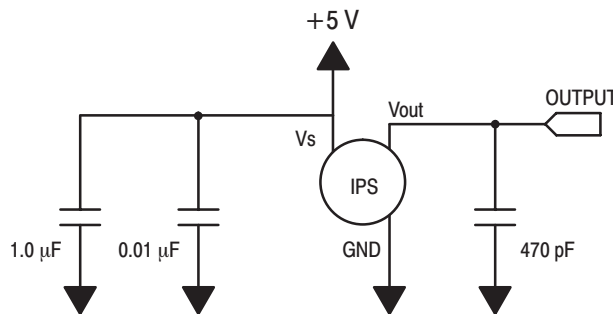

Figure 4. Recommended power supply decoupling and output filtering.

For additional output filtering, please refer to Application Note AN1646.

MPX4080D

Transfer Function (MPX4080D)

Nominal Transfer Value: $V_{out} = V_S (P \times 0.01059 + 0.11280)$
 \pm (Pressure Error x Temp. Mult. x 0.01059 x V_S)
 $V_S = 5.1 \text{ V} \pm 0.25\text{V P kPa}$

Temperature Error Multiplier

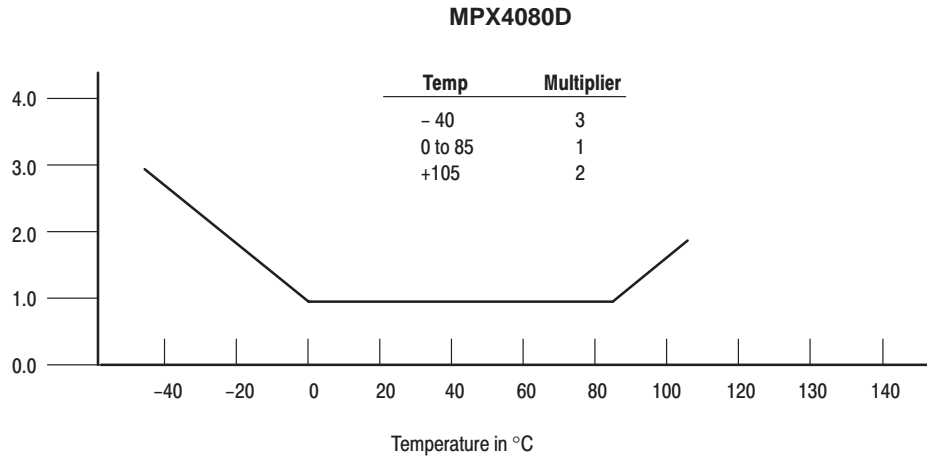

NOTE: The Temperature Multiplier is a linear response from 0° to -40°C and from 85° to 105°C.

Pressure Error Band

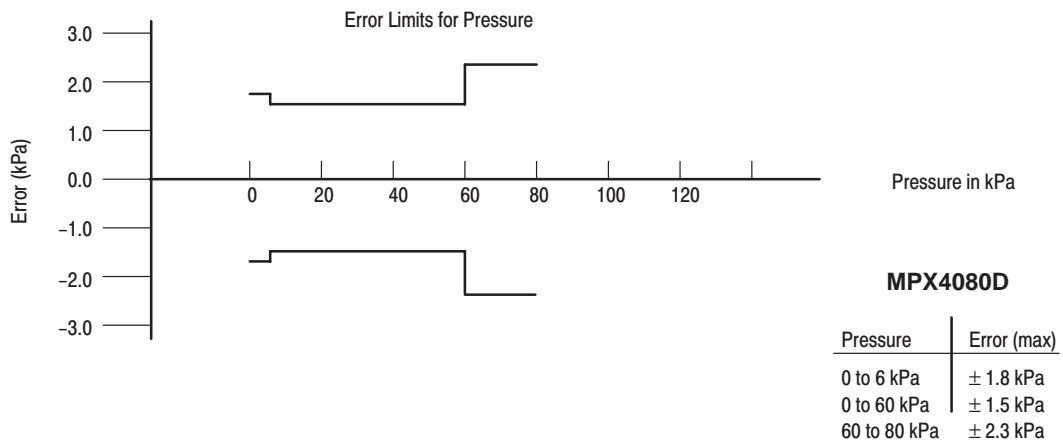

MPX4080D**PRESSURE (P1)/VACUUM (P2) SIDE IDENTIFICATION TABLE**

Motorola designates the two sides of the pressure sensor as the Pressure (P1) side and the Vacuum (P2) side. The Pressure (P1) side is the side containing fluoro silicone gel which protects the die from harsh media. The Motorola pres-

sure sensor is designed to operate with positive differential pressure applied, $P1 > P2$.

The Pressure (P1) side is identified by the stainless steel cap.

ORDERING INFORMATION:

The MPX4080D is available only in the unibody package.

Device Order No.	Device Type	Case No.	Device Marking
MPX4080D	Differential	867	MPX4080D

MPX4080D

PACKAGE DIMENSIONS

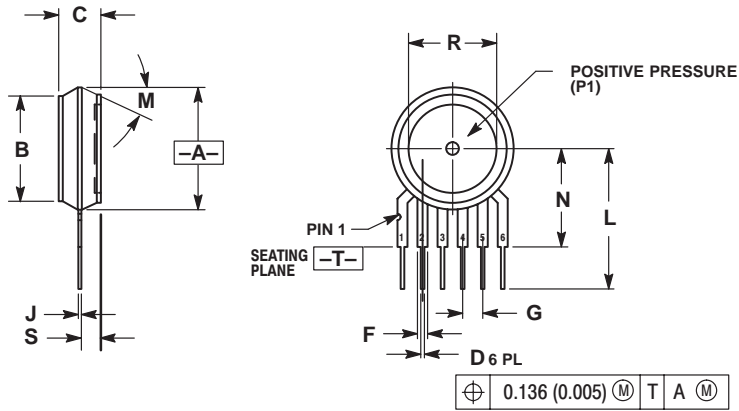

- NOTES:
7. DIMENSIONING AND TOLERANCING PER ANSI Y14.5M, 1982.
 8. CONTROLLING DIMENSION: INCH.
 9. DIMENSION -A- IS INCLUSIVE OF THE MOLD STOP RING. MOLD STOP RING NOT TO EXCEED 16.00 (0.630).

DIM	INCHES		MILLIMETERS	
	MIN	MAX	MIN	MAX
A	0.595	0.630	15.11	16.00
B	0.514	0.534	13.06	13.56
C	0.200	0.220	5.08	5.59
D	0.027	0.033	0.68	0.84
F	0.048	0.064	1.22	1.63
G	0.100 BSC		2.54 BSC	
J	0.014	0.016	0.36	0.40
L	0.695	0.725	17.65	18.42
M	30° NOM		30° NOM	
N	0.475	0.495	12.07	12.57
R	0.430	0.450	10.92	11.43
S	0.090	0.105	2.29	2.66

- STYLE 1:
 PIN 1. VOUT
 2. GROUND
 3. VCC
 4. V1
 5. V2
 6. VEX

- STYLE 2:
 PIN 1. OPEN
 2. GROUND
 3. -VOUT
 4. VSUPPLY
 5. +VOUT
 6. OPEN

- STYLE 3:
 PIN 1. OPEN
 2. GROUND
 3. +VOUT
 4. +VSUPPLY
 5. -VOUT
 6. OPEN

**CASE 867-08
 ISSUE N**

BASIC ELEMENT

NOTES

MPX4080D

Motorola reserves the right to make changes without further notice to any products herein. Motorola makes no warranty, representation or guarantee regarding the suitability of its products for any particular purpose, nor does Motorola assume any liability arising out of the application or use of any product or circuit, and specifically disclaims any and all liability, including without limitation consequential or incidental damages. "Typical" parameters which may be provided in Motorola data sheets and/or specifications can and do vary in different applications and actual performance may vary over time. All operating parameters, including "Typicals" must be validated for each customer application by customer's technical experts. Motorola does not convey any license under its patent rights nor the rights of others. Motorola products are not designed, intended, or authorized for use as components in systems intended for surgical implant into the body, or other applications intended to support or sustain life, or for any other application in which the failure of the Motorola product could create a situation where personal injury or death may occur. Should Buyer purchase or use Motorola products for any such unintended or unauthorized application, Buyer shall indemnify and hold Motorola and its officers, employees, subsidiaries, affiliates, and distributors harmless against all claims, costs, damages, and expenses, and reasonable attorney fees arising out of, directly or indirectly, any claim of personal injury or death associated with such unintended or unauthorized use, even if such claim alleges that Motorola was negligent regarding the design or manufacture of the part. Motorola, Inc. Motorola, Inc. is an Equal Opportunity/Affirmative Action Employer. MOTOROLA and the  logo are registered in the US Patent & Trademark Office. All other product or service names are the property of their respective owners.

© Motorola, Inc. 2001.

How to reach us:

USA/EUROPE/Locations Not Listed: Motorola Literature Distribution; P.O. Box 5405, Denver, Colorado 80217. 1-303-675-2140 or 1-800-441-2447

JAPAN: Motorola Japan Ltd.; SPS, Technical Information Center, 3-20-1, Minami-Azabu. Minato-ku, Tokyo 106-8573 Japan. 81-3-3440-3569

ASIA/PACIFIC: Motorola Semiconductors H.K. Ltd.; Silicon Harbour Centre, 2 Dai King Street, Tai Po Industrial Estate, Tai Po, N.T., Hong Kong. 852-26668334

Technical Information Center: 1-800-521-6274

HOME PAGE: <http://www.motorola.com/semiconductors/>

