

TOSHIBA

TMP47P454V

CMOS 4-BIT MICROCONTROLLER

TMP47P454VN

The 47P454V is the OTP microcontroller with 32kbits PROM. For program operation, the programming is achieved by using with EPROM programmer (TMM2764AD type) and adapter socket (BM1119). A.C./D.C characteristics are equivalent to Mask-programed ROM device.

PART No.	ROM	RAM	PACKAGE	ADAPTER SOCKET
TMP47P454VN	OTP 4096 x 8-bit	768 x 4-bit	SDIP30-P-400-1.78	BM1119

PIN ASSIGNMENT (TOP VIEW)

SDIP30-P-400-1.78

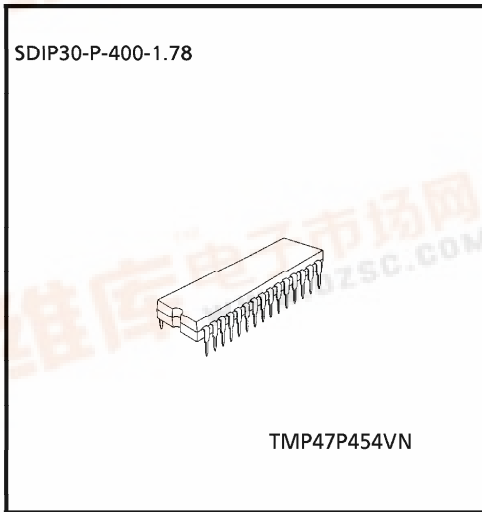
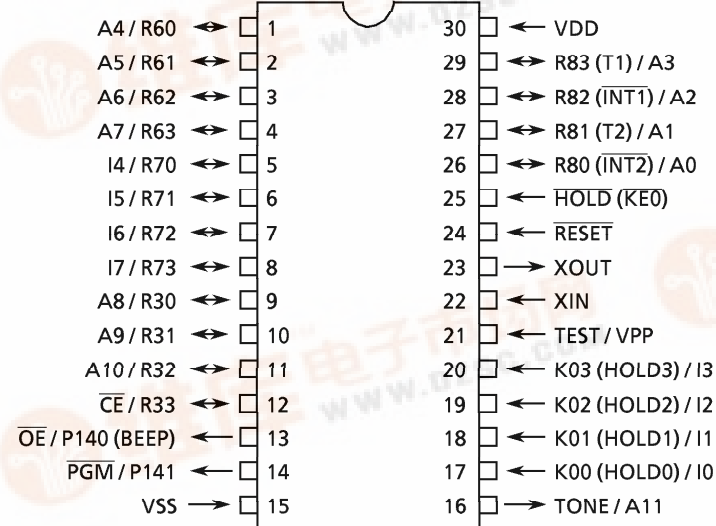

PIN FUNCTION

The 47P454V has MCU mode and PROM mode.

(1) MCU mode

The 47C454A and the 47P454V are pin compatible (TEST pin for out-going test. Be fixed to low level).

(2) PROM mode

PIN NAME	Input/Output	FUNCTIONS	PIN NAME (MCU MODE)
A11	Input	Address inputs	TONE
A10 - A8			R32 - R30
A7 - A4			R63 - R60
A3 - A0			R83 - R80
I7 - I4	I/O	Data inputs / outputs	R73 - R70
I3 - I0			K03 - K00
$\overline{\text{PGM}}$	Input	Program control input	P141
$\overline{\text{CE}}$		Chip Enable input	R33
$\overline{\text{OE}}$		Output Enable input	P140
VPP	Power supply	+ 12.5V / 5V (Program supply voltage)	TEST
VCC		+ 5V	VDD
VSS		0V	VSS
$\overline{\text{RESET}}$	Input	PROM mode setting pins. Be fixed to low level.	
$\overline{\text{HOLD}}$	Input		
XIN	Input	External clock input (to keep the internal state stable)	
XOUT	Output	Open	

OPERATIONAL DESCRIPTION

The following is an explanation of hardware configuration and operation in relation to the 47P454V.

The 47P454V is the same as the 47C454A except that an OTP is used instead of a Mask ROM.

1. OPERATION MODE

The 47P454V has an MCU mode and a PROM mode.

1.1 MCU Mode

The MCU mode is set by fixing the TEST / VPP pin at the "L" level. Operation in the MCU mode is the same as for the 47C454A, except that the TEST / VPP pin does not have pull-down resistor and cannot be used open.

1.1.1 Program Memory

The program storage area is the same as for the 47C454A.

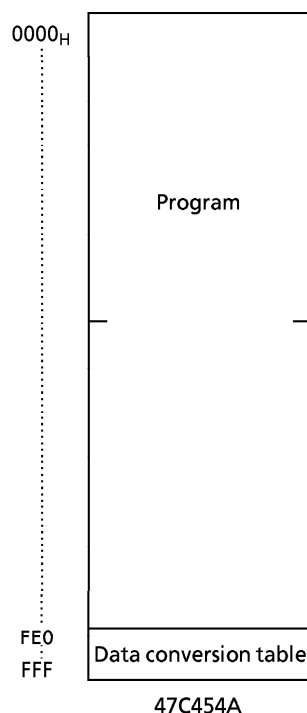

Figure 1-1. Program area

1.1.2 Data Memory

The 47P454V has 768 × 4-bit data memory.

1.1.3 Input/Output Circuitry

(1) Control pins

This is the same as for the 47C454A except that there is no built-in pull-down resistance for the TEST pin.

(2) I/O Ports

The input/output circuit of the 47P454V is the same as I/O code WB of the 47C454A.

External resistance, for example, is required when using as evaluator of other I/O codes (WE, WH) (Refer to Figure 1-2).

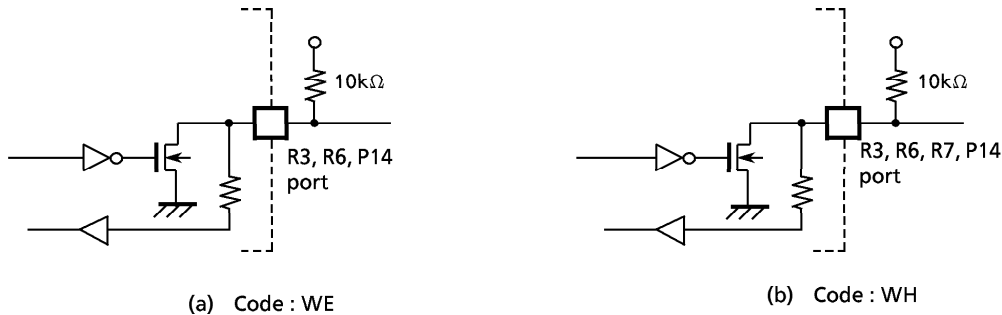

Figure 1-2. I/O code and external circuitry

1.2 PROM Mode

The PROM mode is set by setting the $\overline{\text{RESET}}$, $\overline{\text{HOLD}}$ pins to the "L" level. The PROM mode can be used as a general-purpose PROM writer for program writing and verification (A high-speed program mode is used set the ROM type the same as for the TMM2764AD).

An adapter socket (part No. BM1119) is available for connecting a PROM writer.

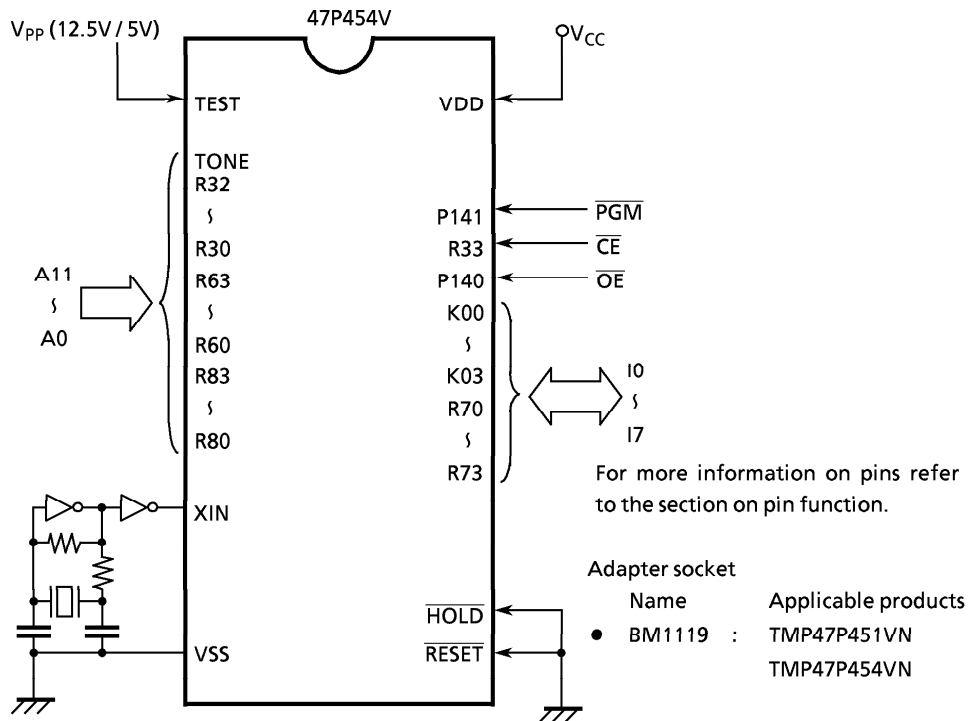

Figure 1-3. Setting for PROM mode

1.2.1 Writing

Set the PROM writer ROM to TMM2764AD (64k-bit), or equivalent. Before writing to a 47P454V (32k-bit), set the data area for writing to 32k-bits (start address : 0000H, ending address : 0FFFH), or else load the same data to the first 32k bits (0000H - 0FFFH) and the second 32k bits (1000H - 1FFFH).

1.2.2 High Speed Programming Mode

The device is set up in the high speed programming mode when the programming voltage (12.5V) is applied to the Vpp terminal with Vcc = 6V and PGM = VIH4. The programming is achieved by applying a Single TTL low level 1 ms, pulse the PGM input after addresses and data are stable. Then the programmed data is verified by using program Verify Mode. If the programmed data is not correct, another program pulse of 1 ms is applied and then programmed data is verified. This should be repeated until the program operates correctly (max. 15 times). After correctly programming the selected address, one additional program pulse with pulse width 4 times that needed for programming is applied. When programming has been completed, the data in all addresses should be verified with Vcc = Vpp = 5V.

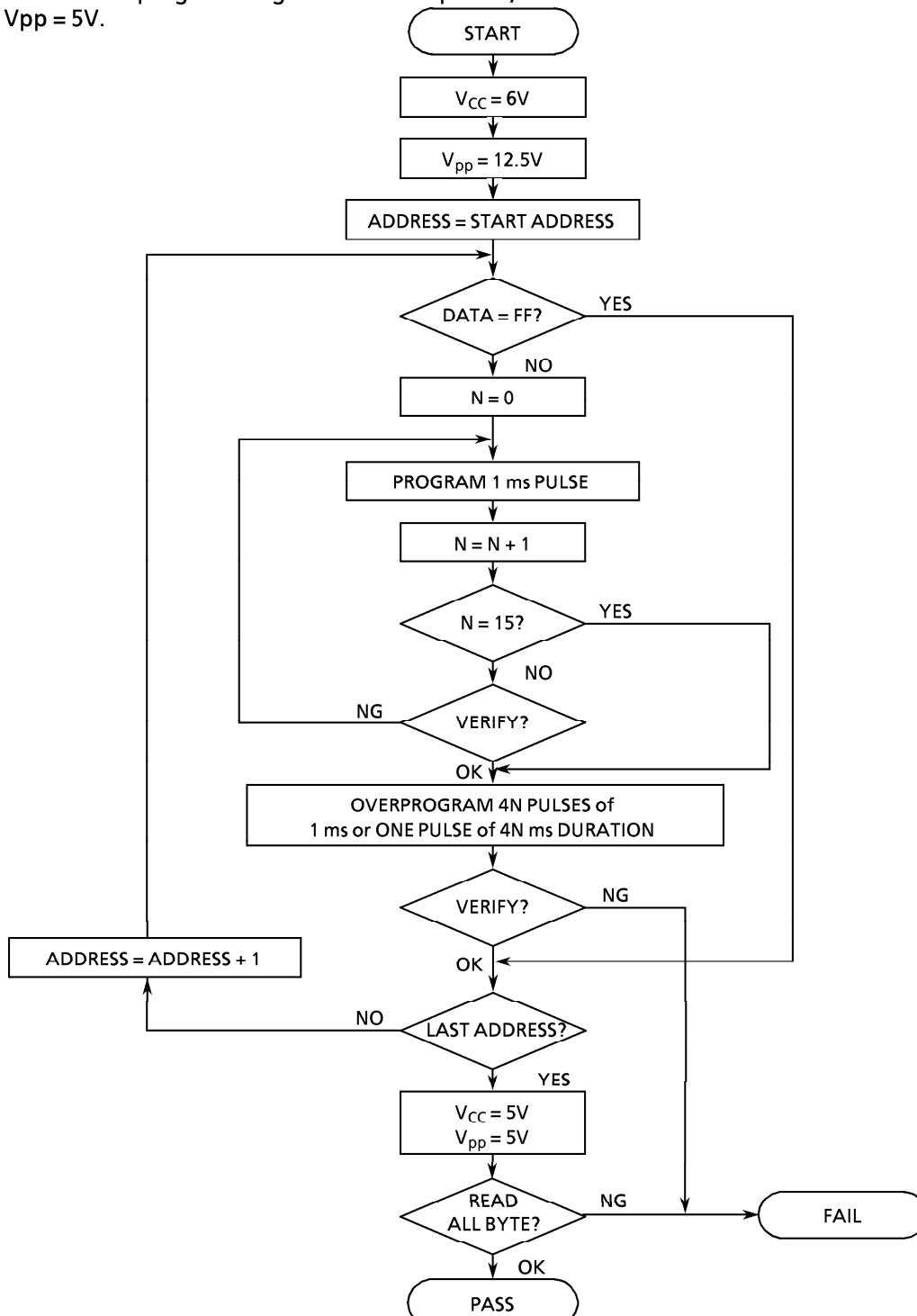

Figure1-4. FLOW CHART

ELECTRICAL CHARACTERISTICS

ABSOLUTE MAXIMUM RATINGS (V_{SS} = 0V)

PARAMETER	SYMBOL	PINS	RATINGS	UNIT
Supply Voltage	V _{DD}		- 0.3 to 7	V
Program Voltage	V _{PP}	TEST/VPP pin	- 0.3 to 14.0	V
Input Voltage	V _{IN}		- 0.3 to V _{DD} + 0.3	V
Output Voltage	V _{OUT1}	Except sink open drain pin, but include R7	- 0.3 to V _{DD} + 0.3	V
	V _{OUT2}	Sink open drain pin except R7	- 0.3 to 10	
Output Current (per 1 pin)	I _{OUT}		3.2	mA
Power Dissipation (T _{opr} = 60°C)	PD		600	mW
Soldering Temperature (time)	T _{slid}		260 (10s)	°C
Storage Temperature	T _{stg}		- 55 to 125	°C
Operating Temperature	T _{opr}		- 30 to 60	°C

Note. Characteristic of R7 is different from 47C454A.

RECOMMENDED OPERATING CONDITIONS (V_{SS} = 0V, T_{opr} = - 30 to 60°C)

PARAMETER	SYMBOL	PINS	CONDITIONS	Min.	Max.	UNIT
Supply Voltage	V _{DD}		In the Normal mode	2.7	6.0	V
			In the HOLD mode	2.0		
Input High Voltage	V _{IH1}	Except hysteresis input	V _{DD} ≥ 4.5V	V _{DD} × 0.7	V _{DD}	V
	V _{IH2}	Hysteresis input		V _{DD} × 0.75		
	V _{IH3}		V _{DD} < 4.5V	V _{DD} × 0.9		
Input Low Voltage	V _{IL1}	Except hysteresis input	V _{DD} ≥ 4.5V	0	V _{DD} × 0.3	V
	V _{IL2}	Hysteresis input			V _{DD} × 0.25	
	V _{IL3}		V _{DD} < 4.5V		V _{DD} × 0.1	
Clock Frequency	f _c			3.84		MHz

D.C. CHARACTERISTICS ($V_{SS} = 0V$, $V_{DD} = 2.7$ to $6.0V$, $T_{opr} = -30$ to $60^{\circ}C$)

PARAMETER	SYMBOL	PINS	CONDITIONS	Min.	Typ.	Max.	UNIT
Hysteresis Voltage	V_{HS}	Hysteresis Input		—	0.7	—	V
Input Current	I_{IN1}	Port, K0 TEST, \overline{RESET} , \overline{HOLD}	$V_{DD} = 5.5V$,	—	—	± 2	μA
	I_{IN2}	Port R (open drain)	$V_{IN} = 5.5V / 0V$				
Input Low Current	I_{IL}	Port R (push-pull)	$V_{DD} = 5.5V$, $V_{IN} = 0.4V$	—	—	-2	mA
Input Resistance	R_{IN1}	Port K0		30	70	150	k Ω
	R_{IN2}	\overline{RESET}		100	220	450	
Output Leakage Current	I_{LO}	Ports P, R (open drain)	$V_{DD} = 5.5V$, $V_{OUT} = 5.5V$	—	—	2	μA
Output High Voltage	V_{OH}	Port R (push-pull)	$V_{DD} = 4.5V$, $I_{OH} = -200\mu A$	2.4	—	—	V
Output Low Voltage	V_{OL2}	Except Xout	$V_{DD} = 4.5V$, $I_{OL} = 1.6mA$	—	—	0.4	V
Supply Current (in the Normal mode)	I_{DD}		Except TONE generating $V_{DD} = 5.5V$, $f_c = 3.84MHz$	—	3	6	mA
	I_{DDT}		TONE generating $V_{DD} = 5.5V$, $f_c = 3.84MHz$	—	5	10	
Supply Current (in the HOLD mode)	I_{DDH}		$V_{DD} = 5.5V$,	—	0.5	10	μA

Note 1. Typ values show those at $T_{opr} = 25^{\circ}C$, $V_{DD} = 5V$

Note 2. Input Current I_{IN1} ; The current through resistor is not included, when the pull-up/pull-down resistor is contained.

Note 3. Supply Current ; $V_{IN} = 5.3/0.2V$
 The K0 port is opened when the pull-up/pull-down resistor is contained.
 The voltage applied to the R port is within the valid range V_{IL} or V_{IH} .

TONE OUTPUT CHARACTERISTICS ($V_{SS} = 0V$, $V_{DD} = 2.7$ to $6.0V$, $T_{opr} = -30$ to $60^{\circ}C$)

PARAMETER	SYMBOL	CONDITIONS	Min.	Typ.	Max.	UNIT
Tone Output Voltage (ROW)	V_{TONE}	$R_L \geq 10k\Omega$, $V_{DD} = 3.0V$	135	200	260	mVrms
Tone Output Pre-Emphasis High Band	PEHB	PEHB = $20\log(COL/ROW)$	1	2	3	dB
Tone Output Distortion	DIS		—	—	10	%
Tone Output Frequency Stability	Δf	Except error of osc. frequency	—	—	0.7	%

A.C. CHARACTERISTICS ($V_{SS} = 0V$, $V_{DD} = 2.7$ to $6V$, $T_{opr} = -30$ to $60^{\circ}C$)

PARAMETER	SYMBOL	CONDITIONS	Min.	Typ.	Max.	UNIT
High level Clock Pulse Width	t_{WCH}	External clock mode	80	-	-	ns
Low level Clock Pulse Width	t_{WCL}					
Instruction Cycle Time	t_{cy}		2.1			μs

RECOMMENDED OSCILLATING CONDITIONS ($V_{SS} = 0V$, $V_{DD} = 2.7$ to $6.0V$, $T_{opr} = -30$ to $60^{\circ}C$)

Recommended oscillating conditions of the 47P454V are equal to the 47C454A's.

D.C./A.C. CHARACTERISTICS ($V_{SS} = 0V$)

(1) Read Operation

PARAMETER	SYMBOL	CONDITION	Min.	Typ.	Max.	UNIT
Output Level High Voltage	V_{IH4}		$V_{CC} \times 0.7$	-	V_{CC}	V
Output Level Low Voltage	V_{IL4}		0	-	$V_{CC} \times 0.3$	V
Supply Voltage	V_{CC}		4.75	-	6.0	V
Programming Voltage	V_{PP}					
Address Access Time	t_{ACC}	$V_{CC} = 5.0 \pm 0.25V$	-	-	350	ns

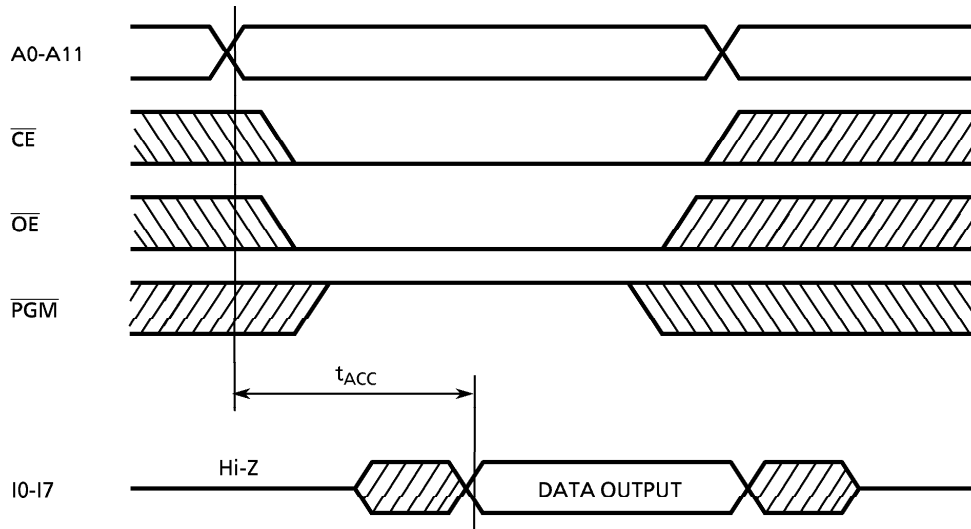

(2) High Speed Programming Operation

PARAMETER	SYMBOL	CONDITION	Min.	Typ.	Max.	UNIT
Input High Voltage	V_{IH4}		$V_{CC} \times 0.7$	-	V_{CC}	V
Input Low Voltage	V_{IL4}		0	-	$V_{CC} \times 0.3$	V
Supply Voltage	V_{CC}		4.75	-	6.0	V
V_{PP} Power Supply Voltage	V_{PP}		12.0	12.5	13.0	V
Programming Pulse Width	t_{PW}	$V_{CC} = 6.0 \pm 0.25V$	0.95	1.0	1.05	ms

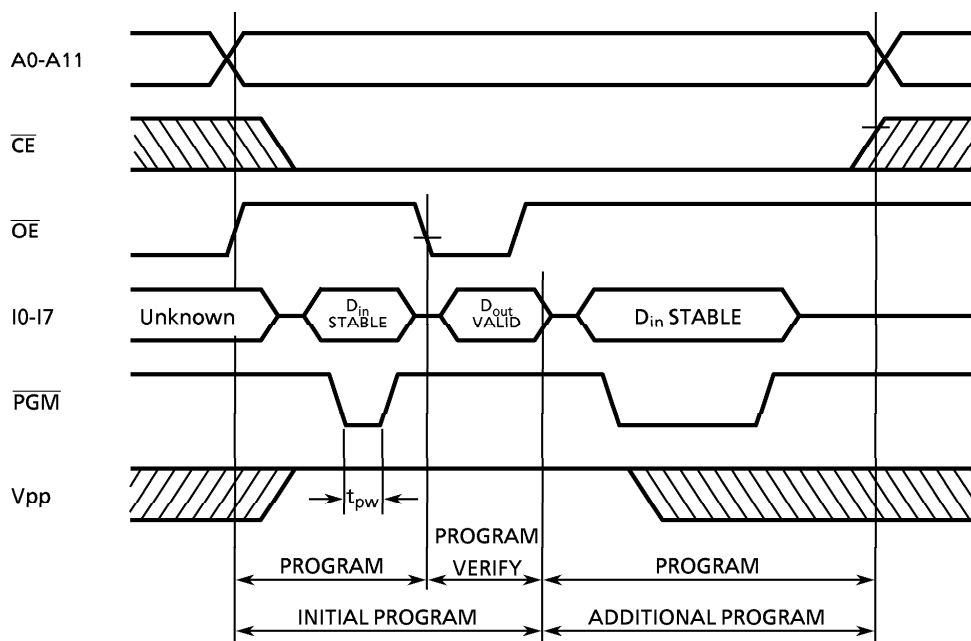

TYPICAL CHARACTERISTICS

