

LM2931A

Low Dropout Voltage Regulator

Features

- Limited input voltage and high efficiency.
- Internal thermal over load protection.
- 60V load dump protection.
- Output current up to 0.1A.

Description

LM2931A is a fixed 3-terminal low dropout voltage regulator designed to need very low quiescent current. Internally, implemented circuits include 60V load dump protection, -50V reverse transient short circuit and thermal over load protection.

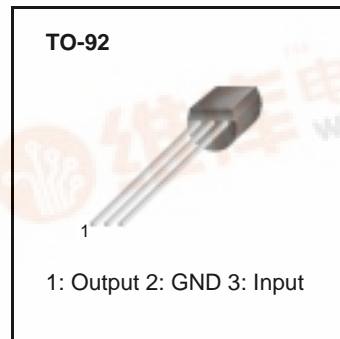

Internal Block Diagram

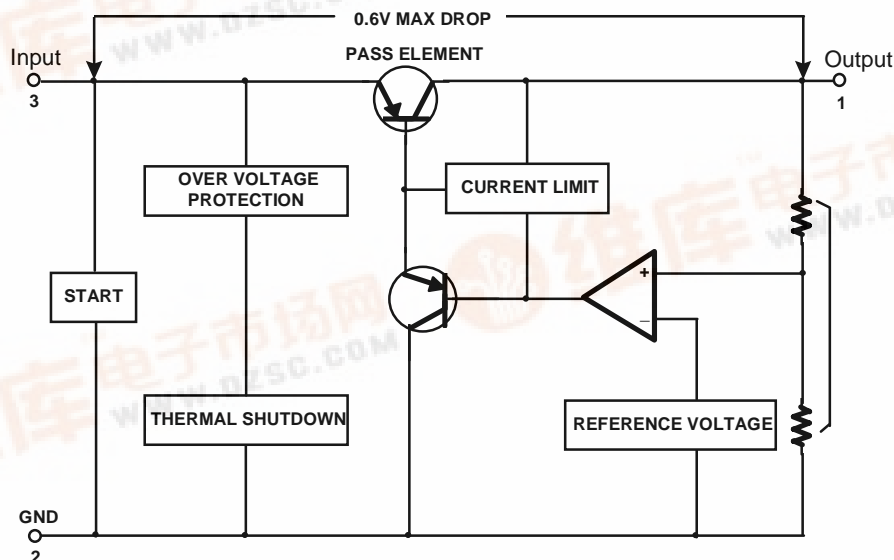

Absolute Maximum Ratings

Parameter	Symbol	Value	Unit
Input Voltage	V_I	33	V
Over Protection Voltage	$V_{(OP)}$	60	V
Operating Temperature Range	TOPR	-40~+125	°C
Maximum Junction Temperature	T_J	150	°C
Storage Temperature Range	TSTG	-65~+150	°C

Electrical Characteristics

($V_I = 14V$, $I_O = 10mA$, $C_O = 100\mu F$, $T_A = 25^\circ C$)

Parameter	Symbol	Conditions	Min.	Typ.	Max.	Unit
Output Voltage (I)	V_O (I)	$V_I = 14V$, $I_O = 10mA$	4.81	5.0	5.19	V
Output Voltage (II)	V_O (II)	$V_I = 6 \sim 26V$, $I_O = 100mA$ $T_J = -40 \sim +125^\circ C$	4.75	5.0	5.25	V
Line Regulation (I)	ΔV_O (I)	$V_I = 9 \sim 16V$, $I_O = 10mA$	-	2.0	10	mV
Line Regulation (II)	ΔV_O (II)	$V_I = 6 \sim 26V$, $I_O = 10mA$	-	4.0	30	mV
Load Regulation	ΔV_O (III)	$V_I = 14V$, $I_O = 5 \sim 100mA$	-	10	50	mV
Output Impedance	Z_O	$V_I = 14V$, $I_O = 100mA$	-	100	600	$m\Omega$
Quiescent Current (I)	I_Q (I)	$V_I = 6 \sim 26V$, $I_O \leq 10mA$	-	0.1	1.0	mA
Quiescent Current (II)	I_Q (II)	$V_I = 14V$, $I_O \leq 100mA$	-	5.0	30	mA
Output Noise Voltage	V_N	$V_I = 14V$, $I_O = 10mA$, $f = 10Hz \sim 100KHz$	-	150	1000	μV_{rms}
Ripple Rejection	RR	$V_I = 14V$, $I_O = 10mA$, $f = 120Hz$	55	80	-	dB
Dropout Voltage (I)	V_D (I)	$I_O = 10mA$, $V_D = V_I - V_O$	-	0.03	0.2	V
Dropout Voltage (II)	V_D (II)	$I_O = 100mA$, $V_D = V_I - V_O$	-	0.1	0.6	V
Max Operational Input Voltage	V_{IN}	$I_O = 10mA$	26	33	-	V
Max Line Transient	$V_{LT(MAX)}$	$V_I = 14V$, $I_O = 10mA$, Time = 100ms	60	70	-	V
Reverse Polarity Input Voltage DC	$V_{I(DC)}$	$V_I = 14V$, $I_O = 10mA$, $V_O \geq -0.3V$	- 15	- 30	-	V
Reverse Polarity Input Voltage Transient	$V_{I(TR)}$	$V_I = 14V$, $I_O = 10mA$, Time $\leq 10ms$	- 50	- 80	-	V
Peak Output Current	IPK	$V_I = 14V$	200	400	600	mA

Typical Performance Characteristics

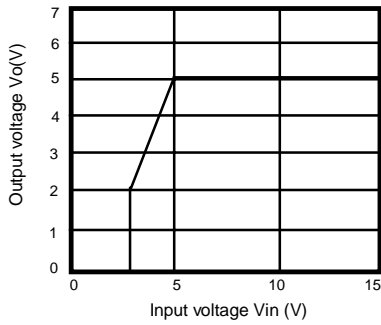

Figure 1. Output Voltage vs. Input Voltage

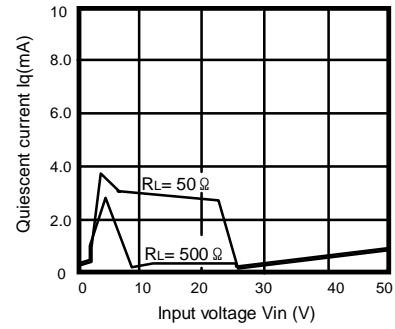

Figure 2. Quiescent Current vs. Input Voltage

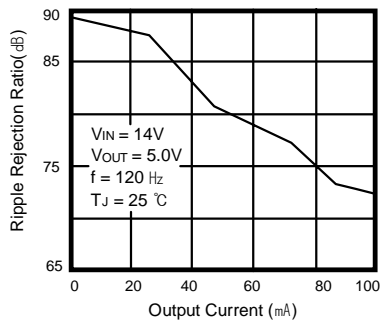

Figure 3. Ripple Rejection vs. Output Current

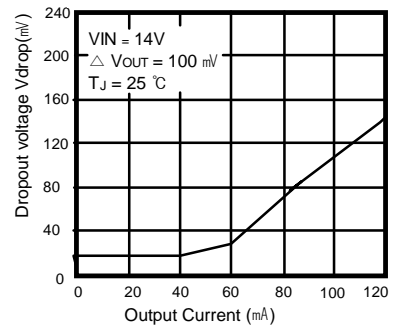

Figure 4. Drop Voltage vs. Output Current

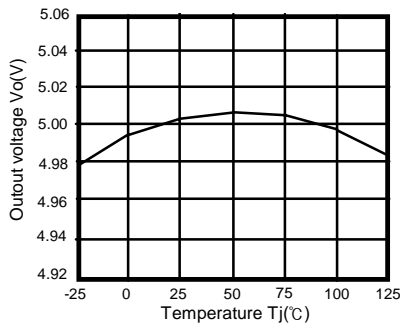

Figure 5. Output Voltage vs. Temperature(T_j)

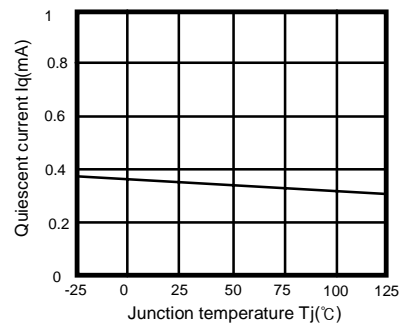

Figure 6. Quiescent Current vs. Temperature(T_j)

Typical Application

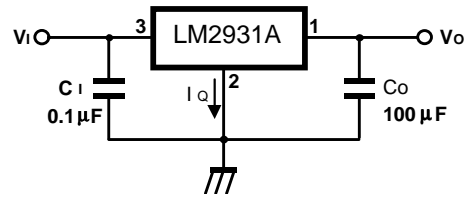

Figure 1. Application Circuit

- C_i is required if regulator is located an appreciable distance from power supply filter.
- C_o improves stability .

Mechanical Dimensions

Package

Dimensions in millimeters

TO-92

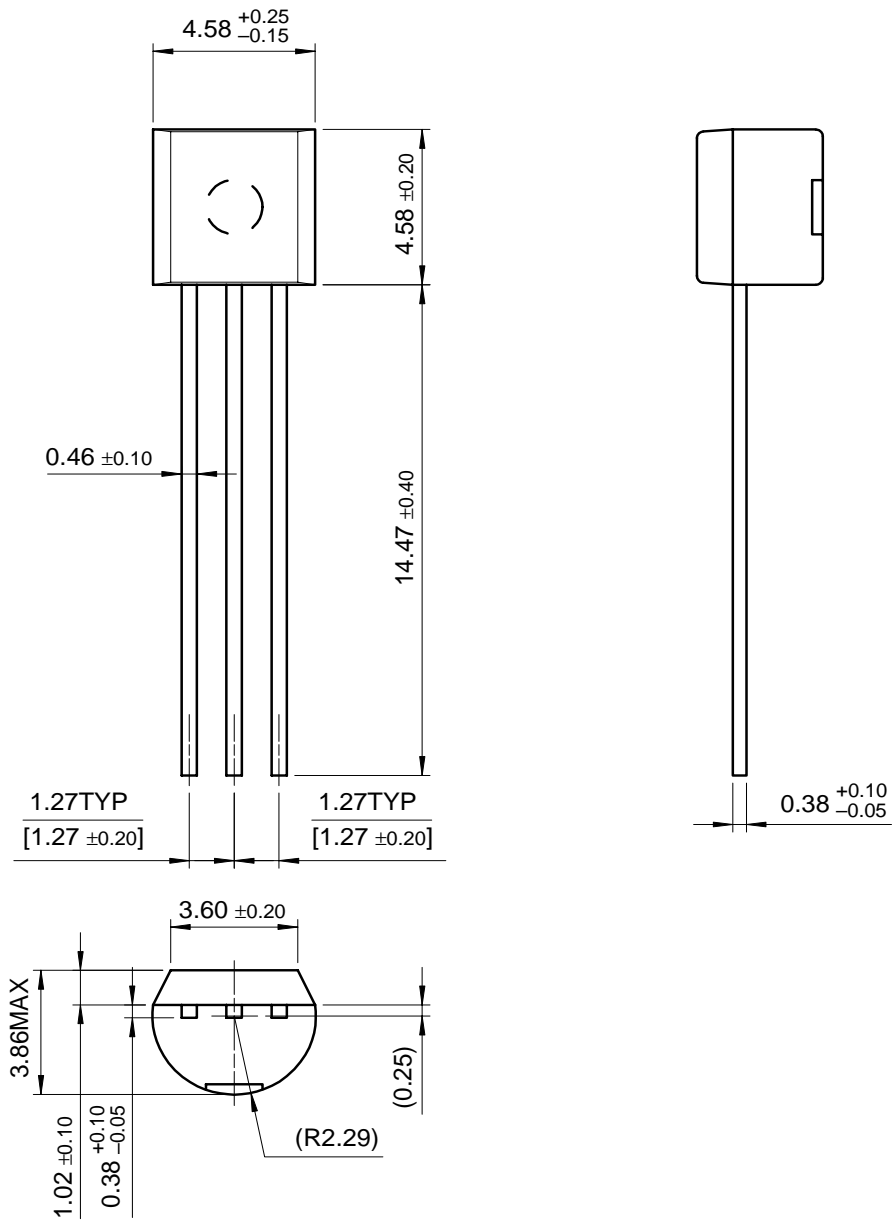

LM2931A

Ordering Information

Product Number	Package	Operating Temperature
LM2931AZ5	TO-92	-40°C to + 125°C

DISCLAIMER

FAIRCHILD SEMICONDUCTOR RESERVES THE RIGHT TO MAKE CHANGES WITHOUT FURTHER NOTICE TO ANY PRODUCTS HEREIN TO IMPROVE RELIABILITY, FUNCTION OR DESIGN. FAIRCHILD DOES NOT ASSUME ANY LIABILITY ARISING OUT OF THE APPLICATION OR USE OF ANY PRODUCT OR CIRCUIT DESCRIBED HEREIN; NEITHER DOES IT CONVEY ANY LICENSE UNDER ITS PATENT RIGHTS, NOR THE RIGHTS OF OTHERS.

LIFE SUPPORT POLICY

FAIRCHILD'S PRODUCTS ARE NOT AUTHORIZED FOR USE AS CRITICAL COMPONENTS IN LIFE SUPPORT DEVICES OR SYSTEMS WITHOUT THE EXPRESS WRITTEN APPROVAL OF THE PRESIDENT OF FAIRCHILD SEMICONDUCTOR CORPORATION. As used herein:

1. Life support devices or systems are devices or systems which, (a) are intended for surgical implant into the body, or (b) support or sustain life, and (c) whose failure to perform when properly used in accordance with instructions for use provided in the labeling, can be reasonably expected to result in a significant injury of the user.
2. A critical component in any component of a life support device or system whose failure to perform can be reasonably expected to cause the failure of the life support device or system, or to affect its safety or effectiveness.