

**FAIRCHILD**  
SEMICONDUCTOR™

November 1988  
Revised November 1999

## 74AC241 • 74ACT241 Octal Buffer/Line Driver with 3-STATE Outputs

### General Description

The AC/ACT241 is an octal buffer and line driver designed to be employed as a memory address driver, clock driver and bus-oriented transmitter or receiver which provides improved PC board density.

### Features

- $I_{CC}$  and  $I_{OZ}$  reduced by 50%
- Non-inverting 3-STATE outputs drive bus lines or buffer memory address registers
- Outputs source/sink 24 mA
- ACT241 has TTL-compatible inputs

### Ordering Code:

Order Number	Package Number	Package Description
74AC241SC	M20B	20-Lead Small Outline Integrated Circuit (SOIC), JEDEC MS-013, 0.300" Wide Body
74AC241SJ	M20D	20-Lead Small Outline Package (SOP), EIAJ TYPE II, 5.3mm Wide
74AC241MTC	MTC20	20-Lead Thin Shrink Small Outline Package (TSSOP), JEDEC MO-153, 4.4mm Wide
74AC241PC	N20A	20-Lead Plastic Dual-In-Line Package (PDIP), JEDEC MS-001, 0.300" Wide
74ACT241SC	M20B	20-Lead Small Outline Integrated Circuit (SOIC), JEDEC MS-013, 0.300" Wide Body
74ACT241SJ	M20D	20-Lead Small Outline Package (SOP), EIAJ TYPE II, 5.3mm Wide
74ACT241MTC	MTC20	20-Lead Thin Shrink Small Outline Package (TSSOP), JEDEC MO-153, 4.4mm Wide
74ACT241PC	N20A	20-Lead Plastic Dual-In-Line Package (PDIP), JEDEC MS-001, 0.300" Wide

Device also available in Tape and Reel. Specify by appending suffix letter "X" to the ordering code.

### Logic Symbol

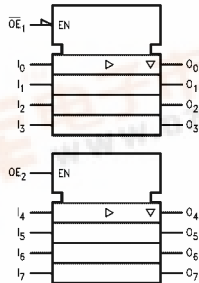

### Connection Diagram

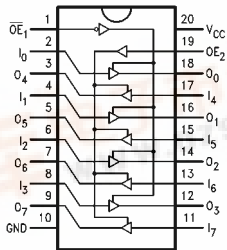

FACT™ is a trademark of Fairchild Semiconductor Corporation.

### Pin Descriptions

Pin Names	Description
$\overline{OE}_1$	3-STATE Output Enable Input
$OE_2$	3-STATE Output Enable Input (Active HIGH)
$I_0$ - $I_7$	Inputs
$O_0$ - $O_7$	Outputs

### Truth Tables

Inputs		Outputs
$\overline{OE}_1$	$I_n$	(Pins 12, 14, 16, 18)
L	L	L
L	H	H
H	X	Z

Inputs		Outputs
$OE_2$	$I_n$	(Pins 3, 5, 7, 9)
H	L	L
H	H	H
L	X	Z

H = HIGH Voltage Level  
L = LOW Voltage Level  
X = Immaterial  
Z = High Impedance

74AC241 • 74ACT241 Octal Buffer/Line Driver with 3-STATE Outputs



**Absolute Maximum Ratings** (Note 1)

Supply Voltage ( $V_{CC}$ )	-0.5V to +7.0V
DC Input Diode Current ( $I_{IK}$ )	
$V_I = -0.5V$	-20 mA
$V_I = V_{CC} + 0.5V$	+20 mA
DC Input Voltage ( $V_I$ )	-0.5V to $V_{CC} + 0.5V$
DC Output Diode Current ( $I_{OK}$ )	
$V_O = -0.5V$	-20 mA
$V_O = V_{CC} + 0.5V$	+20 mA
DC Output Voltage ( $V_O$ )	-0.5V to $V_{CC} + 0.5V$
DC Output Source	
or Sink Current ( $I_O$ )	$\pm 50$ mA
DC $V_{CC}$ or Ground Current	
per Output Pin ( $I_{CC}$ or $I_{GND}$ )	$\pm 50$ mA
Storage Temperature ( $T_{STG}$ )	-65°C to +150°C
Junction Temperature ( $T_J$ )	
PDIP	140°C

**Recommended Operating Conditions**

Supply Voltage ( $V_{CC}$ )	
AC	2.0V to 6.0V
ACT	4.5V to 5.5V
Input Voltage ( $V_I$ )	0V to $V_{CC}$
Output Voltage ( $V_O$ )	0V to $V_{CC}$
Operating Temperature ( $T_A$ )	-40°C to +85°C
Minimum Input Edge Rate ( $\Delta V/\Delta t$ )	
AC Devices	
$V_{IN}$ from 30% to 70% of $V_{CC}$	
$V_{CC}$ @ 3.3V, 4.5V, 5.5V	125 mV/ns
Minimum Input Edge Rate ( $\Delta V/\Delta t$ )	
ACT Devices	
$V_{IN}$ from 0.8V to 2.0V	
$V_{CC}$ @ 4.5V, 5.5V	125 mV/ns

**Note 1:** Absolute maximum ratings are those values beyond which damage to the device may occur. The databook specifications should be met, without exception, to ensure that the system design is reliable over its power supply, temperature, and output/input loading variables. Fairchild does not recommend operation of FACT™ circuits outside databook specifications.

**DC Electrical Characteristics for AC**

Symbol	Parameter	$V_{CC}(V)$	$T_A = +25^\circ C$		$T_A = -40^\circ C$ to $+85^\circ C$		Units	Conditions	
			Typ	Guaranteed Limits					
$V_{IH}$	Minimum HIGH Level Input Voltage	3.0	1.5	2.1	2.1		V	$V_{OUT} = 0.1V$ or $V_{CC} - 0.1V$	
		4.5	2.25	3.15	3.15				
		5.5	2.75	3.85	3.85				
$V_{IL}$	Maximum LOW Level Input Voltage	3.0	1.5	0.9	0.9		V	$V_{OUT} = 0.1V$ or $V_{CC} - 0.1V$	
		4.5	2.25	1.35	1.35				
		5.5	2.75	1.65	1.65				
$V_{OH}$	Minimum HIGH Level Output Voltage	3.0	2.99	2.9	2.9		V	$I_{OUT} = -50 \mu A$	
		4.5	4.49	4.4	4.4				
		5.5	5.49	5.4	5.4				
			3.0		2.56	2.46		V	$V_{IN} = V_{IL}$ or $V_{IH}$ $I_{OH} = -12$ mA $I_{OH} = -24$ mA $I_{OH} = -24$ mA (Note 2)
			4.5		3.86	3.76			
			5.5		4.86	4.76			
$V_{OL}$	Maximum LOW Level Output Voltage	3.0	0.002	0.1	0.1		V	$I_{OUT} = 50 \mu A$	
		4.5	0.001	0.1	0.1				
		5.5	0.001	0.1	0.1				
			3.0		0.36	0.44		V	$V_{IN} = V_{IL}$ or $V_{IH}$ $I_{OL} = 12$ mA $I_{OL} = 24$ mA $I_{OL} = 24$ mA (Note 2)
			4.5		0.36	0.44			
			5.5		0.36	0.44			
$I_N$ (Note 4)	Maximum Input Leakage Current	5.5		$\pm 0.1$	$\pm 1.0$		$\mu A$	$V_I = V_{CC}, GND$	
$I_{OZ}$	Maximum 3-STATE Leakage Current	5.5		$\pm 0.25$	$\pm 2.5$		$\mu A$	$V_I$ (OE) = $V_{IL}, V_{IH}$ $V_I = V_{CC}, GND$ $V_O = V_{CC}, GND$	
$I_{OLD}$	Minimum Dynamic	5.5			75		mA	$V_{OLD} = 1.65V$ Max	
$I_{OHD}$	Output Current (Note 3)	5.5			-75		mA	$V_{OHD} = 3.85V$ Min	
$I_{CC}$ (Note 4)	Maximum Quiescent Supply Current	5.5		4.0	40.0		$\mu A$	$V_{IN} = V_{CC}$ or GND	

**Note 2:** All outputs loaded; thresholds on input associated with output under test.

**Note 3:** Maximum test duration 2.0 ms, one output loaded at a time.

**Note 4:**  $I_N$  and  $I_{CC}$  @ 3.0V are guaranteed to be less than or equal to the respective limit @ 5.5V  $V_{CC}$ .

### DC Electrical Characteristics for ACT

Symbol	Parameter	V <sub>CC</sub> (V)	T <sub>A</sub> = +25°C		T <sub>A</sub> = -40°C to +85°C		Units	Conditions
			Typ	Guaranteed Limits				
V <sub>IH</sub>	Minimum HIGH Level Input Voltage	4.5	1.5	2.0	2.0	V	V <sub>OUT</sub> = 0.1V or V <sub>CC</sub> - 0.1V	
		5.5	1.5	2.0	2.0			
V <sub>IL</sub>	Maximum LOW Level Input Voltage	4.5	1.5	0.8	0.8	V	V <sub>OUT</sub> = 0.1V or V <sub>CC</sub> - 0.1V	
		5.5	1.5	0.8	0.8			
V <sub>OH</sub>	Minimum HIGH Level Output Voltage	4.5	4.49	4.4	4.4	V	I <sub>OUT</sub> = -50 μA	
		5.5	5.49	5.4	5.4			
			4.5		3.86	3.76	V	V <sub>IN</sub> = V <sub>IL</sub> or V <sub>IH</sub> I <sub>OH</sub> = -24 mA I <sub>OH</sub> = -24 mA (Note 5)
			5.5		4.86	4.76		
V <sub>OL</sub>	Maximum LOW Level Output Voltage	4.5	0.001	0.1	0.1	V	I <sub>OUT</sub> = 50 μA	
		5.5	0.001	0.1	0.1			
			4.5		0.36	0.44	V	V <sub>IN</sub> = V <sub>IL</sub> or V <sub>IH</sub> I <sub>OL</sub> = 24 mA I <sub>OL</sub> = 24 mA (Note 5)
			5.5		0.36	0.44		
I <sub>IN</sub>	Maximum Input Leakage Current	5.5		±0.1	±1.0	μA	V <sub>I</sub> = V <sub>CC</sub> , GND	
I <sub>OZ</sub>	Maximum 3-STATE Leakage Current	5.5		±0.25	±2.5	μA	V <sub>I</sub> = V <sub>IL</sub> , V <sub>IH</sub> V <sub>O</sub> = V <sub>CC</sub> , GND	
I <sub>CCT</sub>	Maximum I <sub>CC</sub> /Input	5.5	0.6		1.5	mA	V <sub>I</sub> = V <sub>CC</sub> - 2.1V	
I <sub>OLD</sub>	Minimum Dynamic	5.5			75	mA	V <sub>OLD</sub> = 1.65V Max	
I <sub>OHD</sub>	Output Current (Note 6)	5.5			-75	mA	V <sub>OHD</sub> = 3.85V Min	
I <sub>CC</sub>	Maximum Quiescent Supply Current	5.5		4.0	40.0	μA	V <sub>IN</sub> = V <sub>CC</sub> or GND	

**Note 5:** All outputs loaded; thresholds on input associated with output under test.

**Note 6:** Maximum test duration 2.0 ms, one output loaded at a time.

### AC Electrical Characteristics for AC

Symbol	Parameter	V <sub>CC</sub> (V) (Note 7)	T <sub>A</sub> = +25°C C <sub>L</sub> = 50 pF			T <sub>A</sub> = -40°C to +85°C C <sub>L</sub> = 50 pF		Units
			Min	Typ	Max	Min	Max	
t <sub>PLH</sub>	Propagation Delay Data to Output	3.3	1.5	6.0	9.0	1.5	10.0	ns
		5.0	1.5	5.0	7.0	1.0	7.5	
t <sub>PHL</sub>	Propagation Delay Data to Output	3.3	1.5	6.0	9.0	1.0	10.5	ns
		5.0	1.5	4.5	7.0	1.0	7.5	
t <sub>PZH</sub>	Output Enable Time	3.3	1.5	6.5	12.5	1.0	13.0	ns
		5.0	1.5	5.5	9.0	1.0	9.5	
t <sub>PZL</sub>	Output Enable Time	3.3	1.5	7.0	12.0	1.5	13.0	ns
		5.0	1.5	5.5	9.0	1.0	9.5	
t <sub>PHZ</sub>	Output Disable Time	3.3	2.0	8.0	12.0	2.0	12.5	ns
		5.0	1.5	6.5	10.0	1.0	10.5	
t <sub>PLZ</sub>	Output Disable Time	3.3	1.5	7.0	12.5	1.0	13.0	ns
		5.0	1.5	6.0	10.0	1.0	10.5	

**Note 7:** Voltage Range 3.3 is 3.3V ± 3.3V

Voltage Range 5.0 is 5.0V ± 0.5V

### AC Electrical Characteristics for ACT

Symbol	Parameter	V <sub>CC</sub> (V) (Note 8)	T <sub>A</sub> = +25°C C <sub>L</sub> = 50 pF			T <sub>A</sub> = -40°C to +85°C C <sub>L</sub> = 50 pF		Units
			Min	Typ	Max	Min	Max	
t <sub>PLH</sub>	Propagation Delay Data to Output	5.0	1.5	6.5	9.0	1.5	10.0	ns
t <sub>PHL</sub>	Propagation Delay Data to Output	5.0	1.5	7.0	9.0	1.5	10.0	ns
t <sub>PZH</sub>	Output Enable Time	5.0	1.5	6.0	9.0	1.0	10.0	ns
t <sub>PZL</sub>	Output Enable Time	5.0	1.5	7.0	10.0	1.5	11.0	ns
t <sub>PHZ</sub>	Output Disable Time	5.0	1.5	8.0	10.5	1.5	11.5	ns
t <sub>PLZ</sub>	Output Disable Time	5.0	2.0	7.0	10.5	1.5	11.5	ns

Note 8: Voltage Range 5.0 is 5.0V ± 0.5V

### Capacitance

Symbol	Parameter	Typ	Units	Conditions
C <sub>IN</sub>	Input Capacitance	4.5	pF	V <sub>CC</sub> = OPEN
C <sub>PD</sub>	Power Dissipation Capacitance	45.0	pF	V <sub>CC</sub> = 5.0V

**Physical Dimensions** inches (millimeters) unless otherwise noted



20-Lead Small Outline Integrated Circuit (SOIC), JEDEC MS-013, 0.300" Wide Body  
Package Number M20B

M20B (REV F)

**Physical Dimensions** inches (millimeters) unless otherwise noted (Continued)

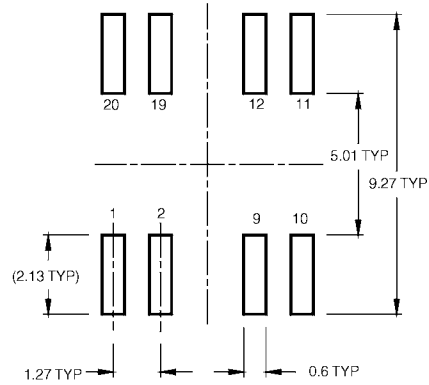
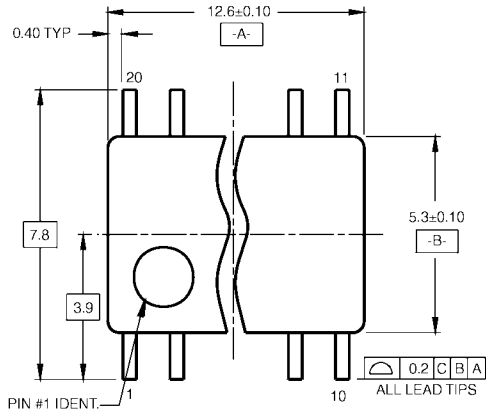

LAND PATTERN RECOMMENDATION

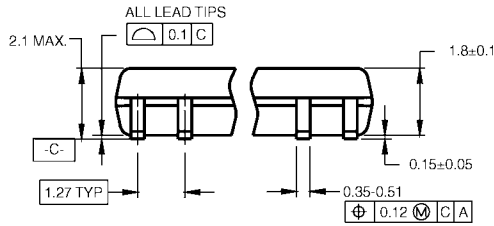

DIMENSIONS ARE IN MILLIMETERS

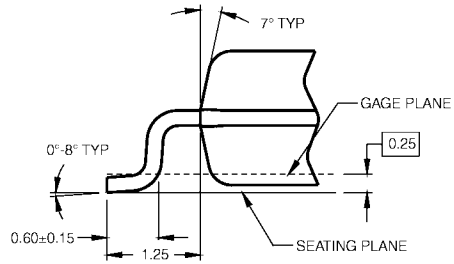
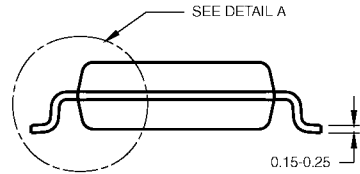

DETAIL A

- NOTES:
- CONFORMS TO EIAJ EDR-7320 REGISTRATION, ESTABLISHED IN DECEMBER, 1998.
  - DIMENSIONS ARE IN MILLIMETERS.
  - DIMENSIONS ARE EXCLUSIVE OF BURRS, MOLD FLASH, AND TIE BAR EXTRUSIONS.

M20DRRevB1

**20-Lead Small Outline Package (SOP), EIAJ TYPE II, 5.3mm Wide  
Package Number M20D**

**Physical Dimensions** inches (millimeters) unless otherwise noted (Continued)

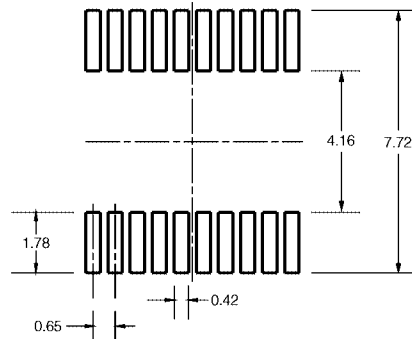
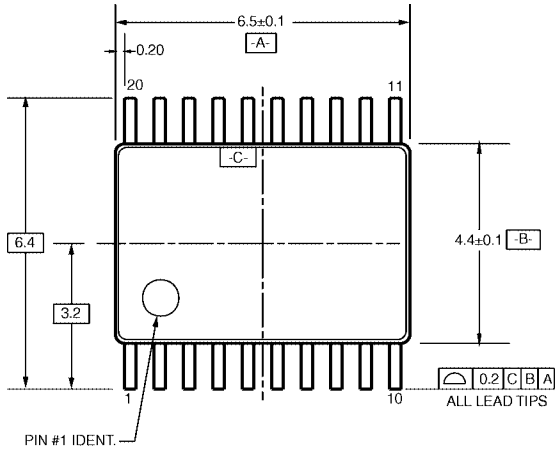

LAND PATTERN RECOMMENDATION

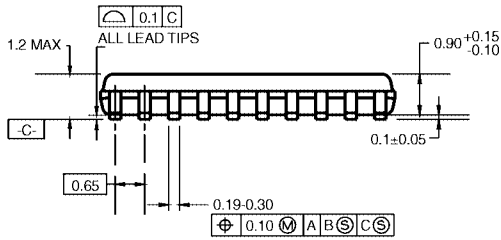

DIMENSIONS ARE IN MILLIMETERS

NOTES:

- A. CONFORMS TO JEDEC REGISTRATION MO-153, VARIATION AC, REF NOTE 6, DATE 7/93.
- B. DIMENSIONS ARE IN MILLIMETERS.
- C. DIMENSIONS ARE EXCLUSIVE OF BURRS, MOLD FLASH, AND TIE BAR EXTRUSIONS.
- D. DIMENSIONS AND TOLERANCES PER ANSI Y14.5M, 1982.

MTC20RevD1

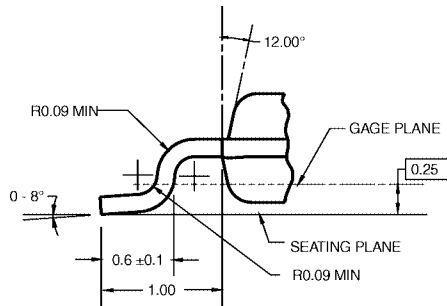
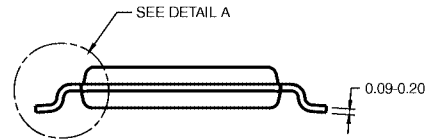

DETAIL A

**20-Lead Thin Shrink Small Outline Package (TSSOP), JEDEC MO-153, 4.4mm Wide  
Package Number MTC20**

**Physical Dimensions** inches (millimeters) unless otherwise noted (Continued)

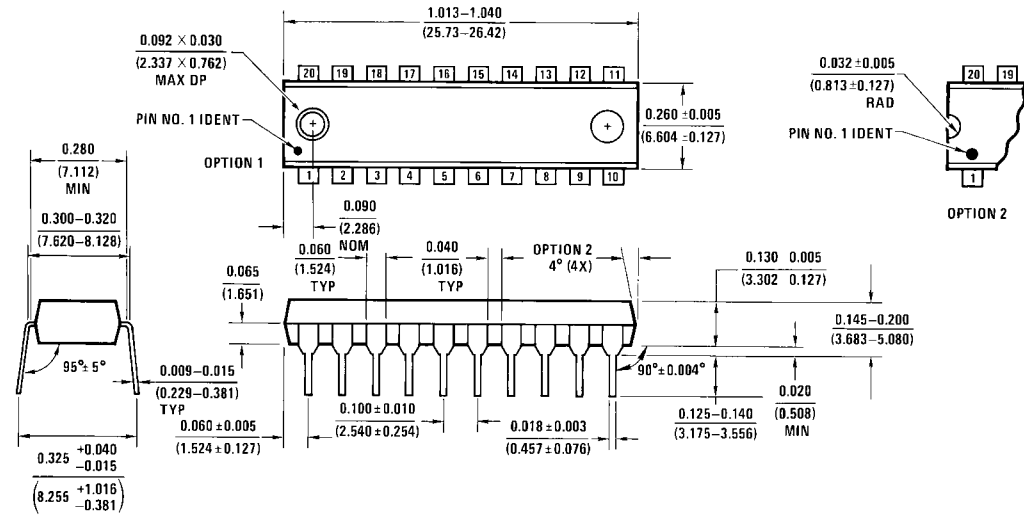

N20A (REV G)

20-Lead Plastic Dual-In-Line Package (PDIP), JEDEC MS-001, 0.300" Wide  
Package Number N20A

Fairchild does not assume any responsibility for use of any circuitry described, no circuit patent licenses are implied and Fairchild reserves the right at any time without notice to change said circuitry and specifications.

**LIFE SUPPORT POLICY**

FAIRCHILD'S PRODUCTS ARE NOT AUTHORIZED FOR USE AS CRITICAL COMPONENTS IN LIFE SUPPORT DEVICES OR SYSTEMS WITHOUT THE EXPRESS WRITTEN APPROVAL OF THE PRESIDENT OF FAIRCHILD SEMICONDUCTOR CORPORATION. As used herein:

1. Life support devices or systems are devices or systems which, (a) are intended for surgical implant into the body, or (b) support or sustain life, and (c) whose failure to perform when properly used in accordance with instructions for use provided in the labeling, can be reasonably expected to result in a significant injury to the user.
2. A critical component in any component of a life support device or system whose failure to perform can be reasonably expected to cause the failure of the life support device or system, or to affect its safety or effectiveness.

[www.fairchildsemi.com](http://www.fairchildsemi.com)