

# International IOR Rectifier

Bulletin I2021 rev. A 07/94

## 300HF(R) SERIES

### STANDARD RECOVERY DIODES

### Stud Version

#### Features

- High current carrying capability
- High surge current capability
- Types up to 1200V  $V_{RRM}$
- Stud cathode and stud anode version
- Standard JEDEC types
- Diffused junction

#### Typical Applications

- Battery chargers
- Converters
- Power supplies
- Machine tool controls

#### Major Ratings and Characteristics

Parameters	300HF(R)	Units
$I_{F(AV)}$	300	A
@ $T_C$	125	°C
$I_{F(RMS)}$	470	A
$I_{FSM}$ @ 50Hz	5000	A
@ 60Hz	5200	A
$I^2t$ @ 50Hz	125	KA <sup>2</sup> s
@ 60Hz	113	KA <sup>2</sup> s
$V_{RRM}$ range	400 to 1200	V
$T_J$	-40 to 180	°C

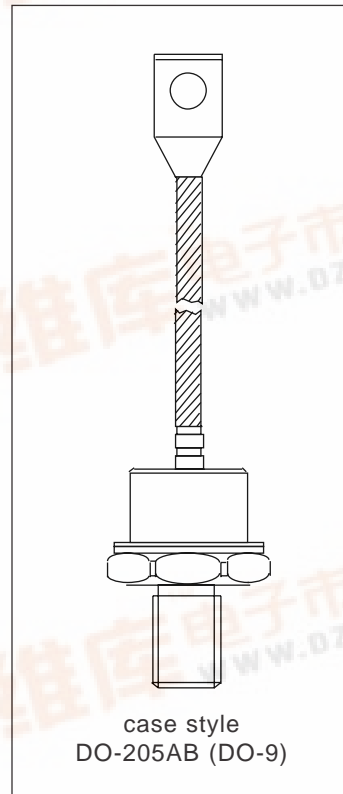
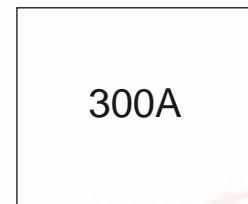

## 300HF(R) Series

Bulletin I2021 rev. A 07/94

International  
IR Rectifier

### ELECTRICAL SPECIFICATIONS

#### Voltage Ratings

Type number	Voltage Code	$V_{RRM}$ , maximum repetitive peak voltage V	$V_{RSM}$ , maximum non-repetitive peak voltage V	$I_{RRM}$ max. @ 180°C mA
300HF(R)	40	400	500	20
	80	800	900	
	120	1200	1300	

#### Forward Conduction

Parameter	300HF(R)	Units	Conditions
$I_{F(AV)}$ Max. average forward current @ Case temperature	300	A	180° conduction, half sine wave
	125	°C	
$I_{F(RMS)}$ Max. RMS forward current	470	A	DC @ 118°C case temperature
$I_{FSM}$ Max. peak, one-cycle forward, non-repetitive surge current	5000	A	t = 10ms No voltage reappplied
	5200		t = 8.3ms reappplied
	3800		t = 10ms 100% $V_{RRM}$ reappplied
	4000		t = 8.3ms reappplied
$I^2t$ Maximum $I^2t$ for fusing	125	KA <sup>2</sup> s	t = 10ms No voltage reappplied
	113		t = 8.3ms reappplied
	72		t = 10ms 100% $V_{RRM}$ reappplied
	66		t = 8.3ms reappplied
$I^2\sqrt{t}$ Maximum $I^2\sqrt{t}$ for fusing	1250	KA <sup>2</sup> /s	t = 0.1 to 10ms, no voltage reappplied
$V_{F(TO)1}$ Low level value of threshold voltage	0.86	V	$(16.7\% \times \pi \times I_{F(AV)} < I < \pi \times I_{F(AV)})$ , $T_J = T_J \text{ max.}$
$V_{F(TO)2}$ High level value of threshold voltage	0.89		$(I > \pi \times I_{F(AV)})$ , $T_J = T_J \text{ max.}$
$r_{f1}$ Low level value of forward slope resistance	0.48	mΩ	$(16.7\% \times \pi \times I_{F(AV)} < I < \pi \times I_{F(AV)})$ , $T_J = T_J \text{ max.}$
$r_{f2}$ High level value of forward slope resistance	0.46		$(I > \pi \times I_{F(AV)})$ , $T_J = T_J \text{ max.}$
$V_{FM}$ Max. forward voltage drop	1.38	V	$I_{FM} = \pi \times I_{F(AV)}$ , $T_J = 25^\circ\text{C}$ , $t_p = 10\text{ms}$ sinusoidal wave

**Thermal and Mechanical Specification**

Parameter	300HF(R)	Units	Conditions
T <sub>J</sub> Max. operating temperature range	-40 to 180	°C	
T <sub>stg</sub> Max. storage temperature range	-55 to 180		
R <sub>thJC</sub> Max. thermal resistance, junction to case	0.12	K/W	DC operation
R <sub>thCS</sub> Max. thermal resistance, case to heatsink	0.05		Mounting surface, smooth, flat and greased
T Max. allowed mounting torque +0 -20%	28	Nm	Not lubricated threads
	22		Lubricated threads
wt Approximate weight	250	g	
Case style	DO-205AB(DO-9)		See Outline Table

**ΔR<sub>thJC</sub> Conduction**

(The following table shows the increment of thermal resistance R<sub>thJC</sub> when devices operate at different conduction angles than DC)

Conduction angle	Sinusoidal conduction	Rectangular conduction	Units	Conditions
180°	0.030	0.022	K/W	T <sub>J</sub> = T <sub>J</sub> max.
120°	0.035	0.037		
90°	0.045	0.048		
60°	0.064	0.066		
30°	0.104	0.105		

**Ordering Information Table**

Device Code					
300	HF	R	120	P	B
①	②	③	④	⑤	⑥
<b>1</b>	- Essential Part Number				
<b>2</b>	- Diode				
<b>3</b>	- None = Stud Normal Polarity (Cathode to Stud) R = Stud Reverse Polarity (Anode to Stud)				
<b>4</b>	- Voltage code: Code x 10 = V <sub>RRM</sub> (See Voltage Ratings table)				
<b>5</b>	- P = Stud base DO-205AB(DO-9) 3/4" 16UNF-2A M = Stud base DO-205AB(DO-9) M16 x 1.5				
<b>6</b>	- B = Flag top terminals (for Cathode/ Anode Leads) S = Isolated lead with silicone sleeve (Red = Reverse Polarity; Blue = Normal Polarity) None = Not isolated lead				

# 300HF(R) Series

Bulletin I2021 rev. A 07/94

## Outline Table

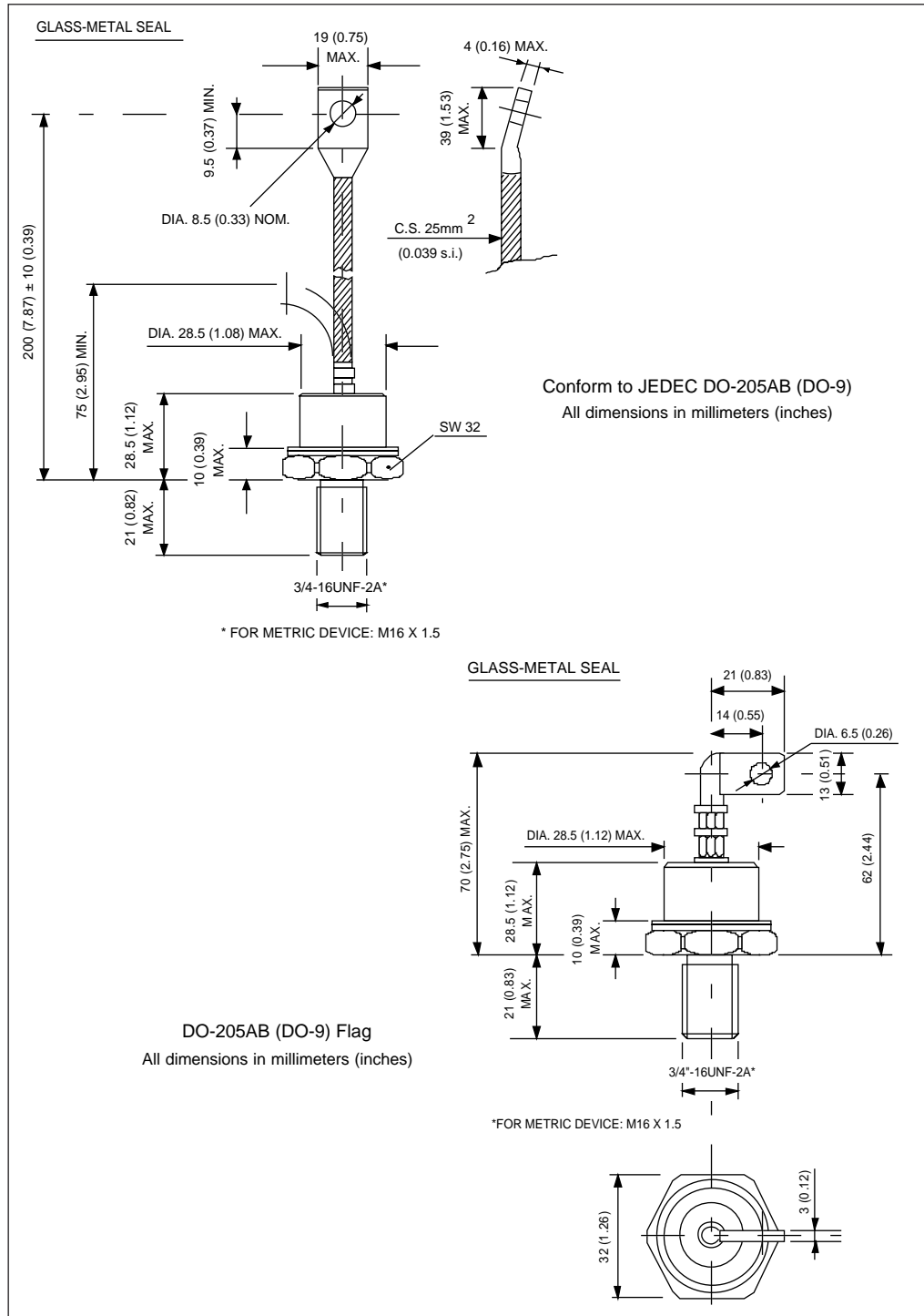

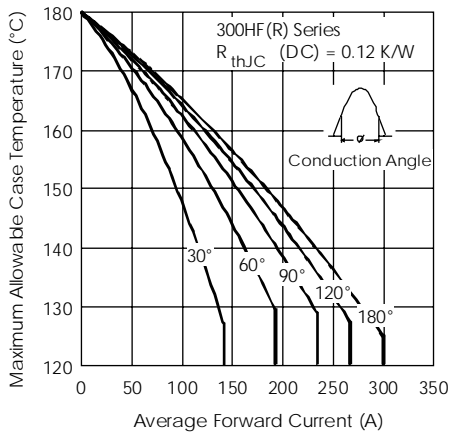

Fig. 1 - Current Ratings Characteristics

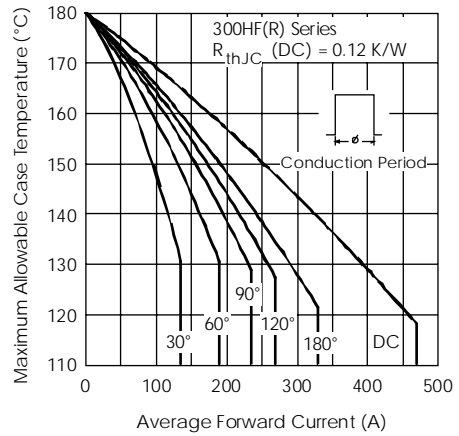

Fig. 2 - Current Ratings Characteristics

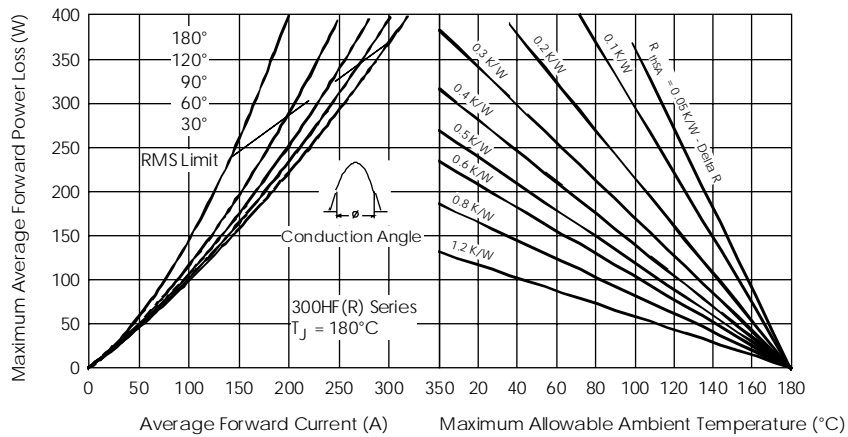

Fig. 3 - Forward Power Loss Characteristics

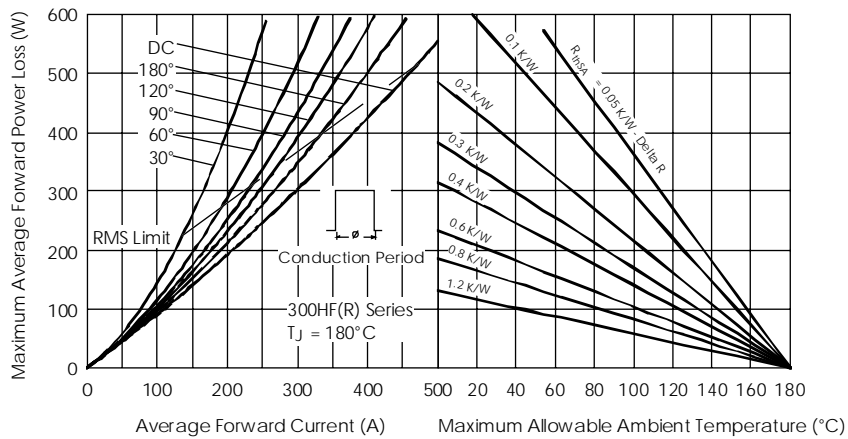

Fig. 4 - Forward Power Loss Characteristics

# 300HF(R) Series

Bulletin I2021 rev. A 07/94

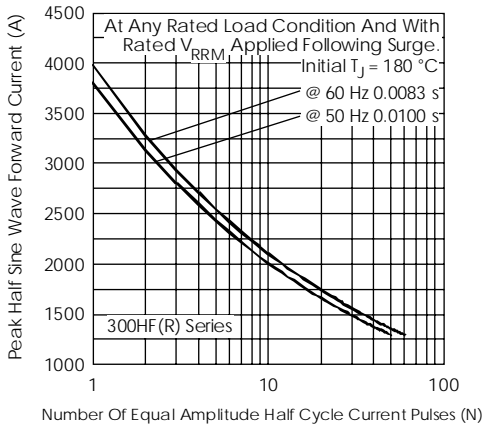

Fig. 5 - Maximum Non-Repetitive Surge Current

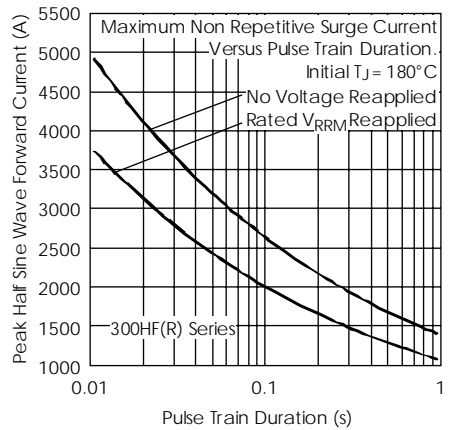

Fig. 6 - Maximum Non-Repetitive Surge Current

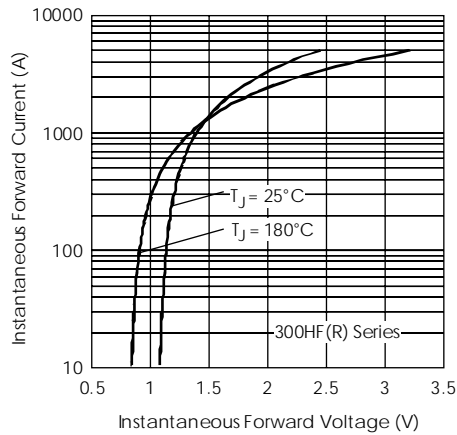

Fig. 7 - Forward Voltage Drop Characteristics

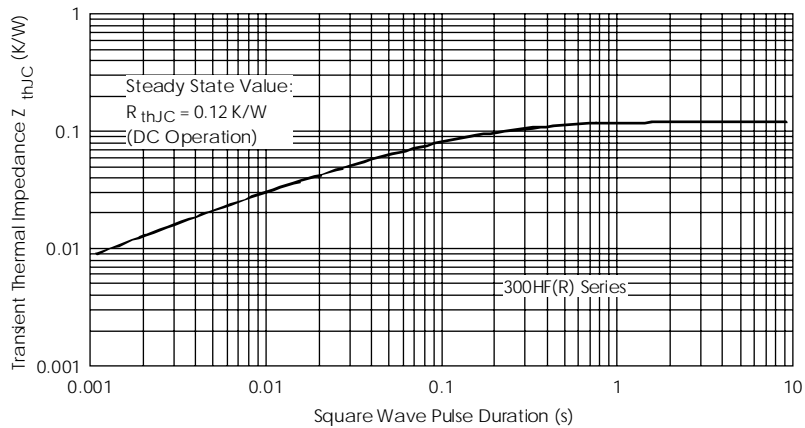

Fig. 8 - Thermal Impedance  $Z_{thJC}$  Characteristic