

Bulletin PD-2.362 rev. D 12/00

International IOR Rectifier

HFA12PA120C

HEXFRED™

Ultrafast, Soft Recovery Diode

Features

- Ultrafast Recovery
- Ultrasoft Recovery
- Very Low I_{RRM}
- Very Low Q_{rr}
- Specified at Operating Conditions

Benefits

- Reduced RFI and EMI
- Reduced Power Loss in Diode and Switching Transistor
- Higher Frequency Operation
- Reduced Snubbing
- Reduced Parts Count

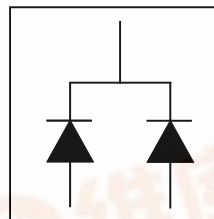

$V_R = 1200V$
$V_F(\text{typ.})^* = 2.4V$
$I_{F(AV)} = 6A$
$Q_{rr}(\text{typ.}) = 116nC$
$I_{RRM}(\text{typ.}) = 4.4A$
$t_{rr}(\text{typ.}) = 26ns$
$di_{(rec)M}/dt(\text{typ.})^* = 100A/\mu s$

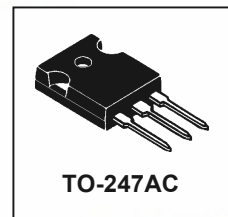

Description

International Rectifier's HFA12PA120C is a state of the art center tap ultra fast recovery diode. Employing the latest in epitaxial construction and advanced processing techniques it features a superb combination of characteristics which results in performance which is unsurpassed by any rectifier previously available. The HFA12PA120C has basic ratings of 1200 volts and 6 amps per leg continuous current. In addition to ultra fast recovery time, the HEXFRED product line features extremely low values of peak recovery current (I_{RRM}) and does not exhibit any tendency to "snap-off" during the t_b portion of recovery. The HEXFRED features combine to offer designers a rectifier with lower noise and significantly lower switching losses in both the diode and the switching transistor. These HEXFRED advantages can help to significantly reduce snubbing, component count and heatsink sizes. The HEXFRED HFA12PA120C is ideally suited for applications in power supplies and power conversion systems (such as inverters, converters, UPS systems, and power factor correction circuits), motor drives, and many other similar applications where high speed, high efficiency is needed.

	Parameter	Max.	Units
V_R	Cathode-to-Anode Voltage	1200	V
$I_F @ T_C = 100^\circ C$	Continuous Forward Current	6.0	A
I_{FSM}	Single Pulse Forward Current	80	
I_{FRM}	Maximum Repetitive Forward Current	24	
$P_D @ T_C = 25^\circ C$	Maximum Power Dissipation	62.5	W
$P_D @ T_C = 100^\circ C$	Maximum Power Dissipation	25	
T_J	Operating Junction and	-55 to +150	°C
T_{STG}	Storage Temperature Range		

* 125°C

HFA12PA120C

Bulletin PD-2.362 rev. D 12/00



Electrical Characteristics @ T_J = 25°C (unless otherwise specified)

	Parameter	Min.	Typ.	Max.	Units	Test Conditions
V _{BR}	Cathode Anode Breakdown Voltage	1200	—	—	V	I _R = 100μA
V _{FM}	Max. Forward Voltage	—	2.7	3.0	V	I _F = 6.0A
		—	3.5	3.9		I _F = 12A
		—	2.4	2.8		I _F = 6.0A, T _J = 125°C
I _{RM}	Max. Reverse Leakage Current	—	0.26	5.0	μA	V _R = V _R Rated
		—	110	500		T _J = 125°C, V _R = 0.8 x V _R Rated
C _T	Junction Capacitance	—	9.0	14	pF	V _R = 200V
L _S	Series Inductance	—	8.0	—	nH	Measured lead to lead 5mm from pkg body

Dynamic Recovery Characteristics @ T_J = 25°C (unless otherwise specified)

	Parameter	Min.	Typ.	Max.	Units	Test Conditions
t _{rr}	Reverse Recovery Time	—	26	—	ns	I _F = 1.0A, di _F /dt = 200A/μs, V _R = 30V
t _{rr1}		—	53	80		T _J = 25°C
t _{rr2}		—	87	130		T _J = 125°C
I _{RRM1}	Peak Recovery Current	—	4.4	8.0	A	T _J = 25°C
I _{RRM2}		—	5.0	9.0		T _J = 125°C
Q _{rr1}	Reverse Recovery Charge	—	116	320	nC	T _J = 25°C
Q _{rr2}		—	233	585		T _J = 125°C
di _{(rec)M} /dt1	Peak Rate of Recovery	—	180	—	A/μs	T _J = 25°C
di _{(rec)M} /dt2	Current During t _b	—	100	—		T _J = 125°C

I_F = 6.0A
V_R = 200V
di_F/dt = 200A/μs

Thermal - Mechanical Characteristics

	Parameter	Min.	Typ.	Max.	Units
T _{lead} ①	Lead Temperature	—	—	300	°C
R _{thJC}	Thermal Resistance, Junction to Case	—	—	2.0	K/W
R _{thJA} ②	Thermal Resistance, Junction to Ambient	—	—	80	
R _{thCS} ③	Thermal Resistance, Case to Heat Sink	—	0.5	—	
Wt	Weight	—	2.0	—	g
		—	0.07	—	(oz)
	Mounting Torque	6.0	—	12	Kg-cm
		5.0	—	10	lbf•in

① 0.063 in. from Case (1.6mm) for 10 sec

② Typical Socket Mount

③ Mounting Surface, Flat, Smooth and Greased

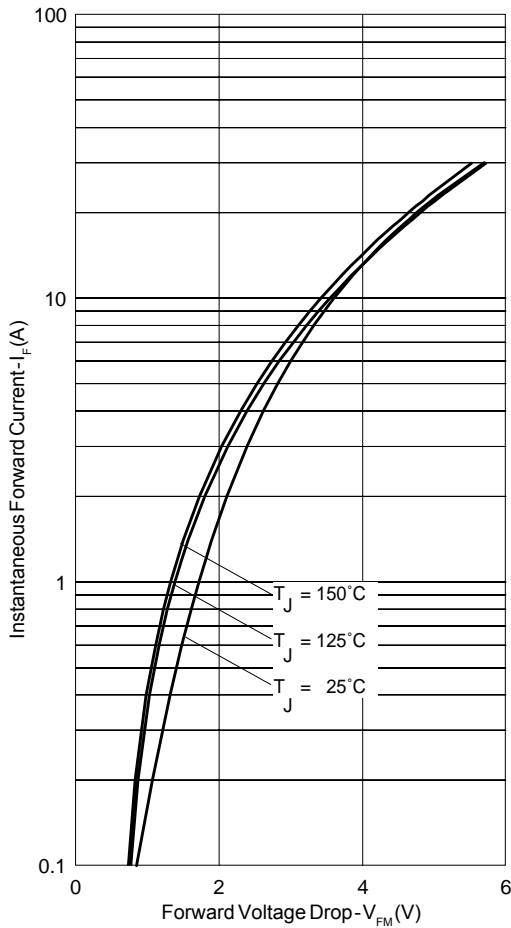

Fig. 1 - Typical Forward Voltage Drop Characteristics

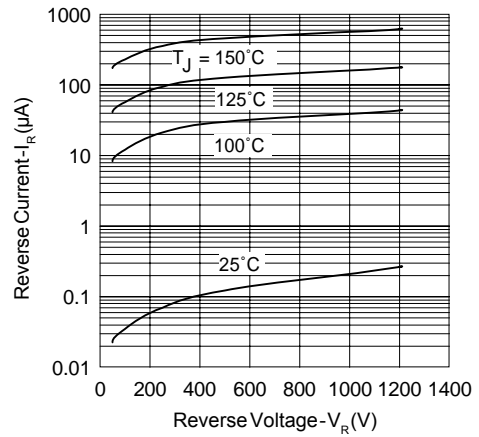

Fig. 3 - Typical Junction Capacitance Vs. Reverse Voltage

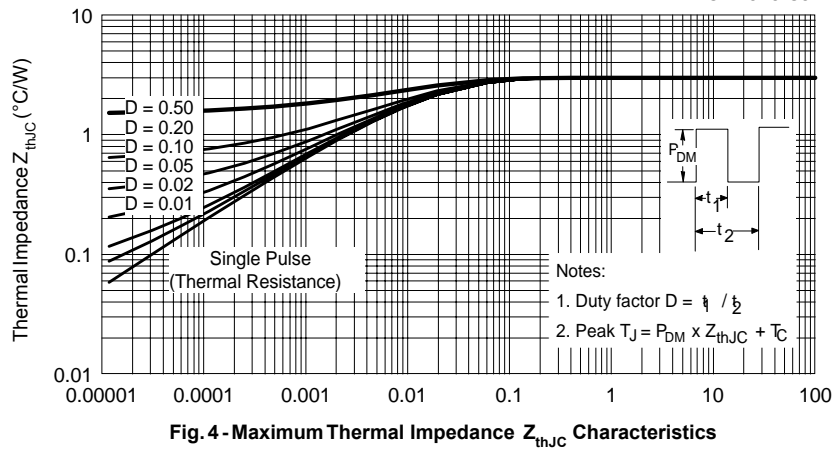
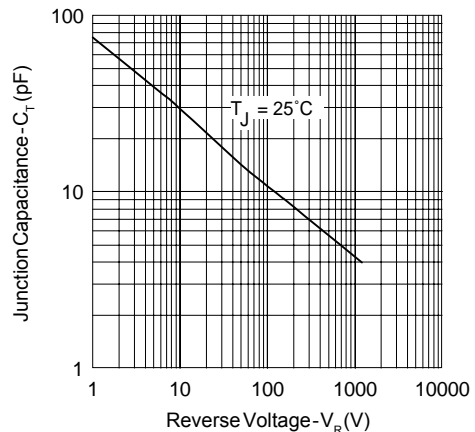

Fig. 4 - Maximum Thermal Impedance Z_{thJC} Characteristics

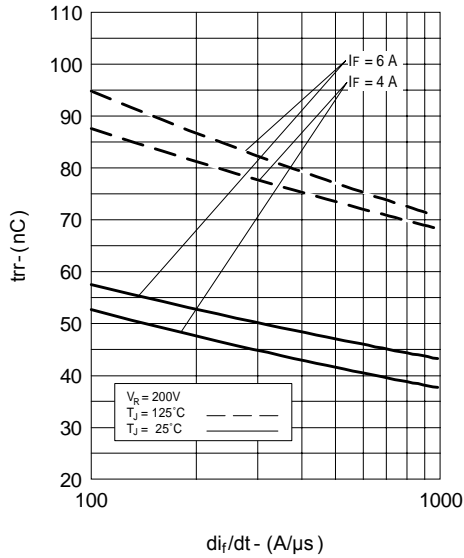

Fig. 5 - Typical Reverse Recovery Vs. di_f/dt

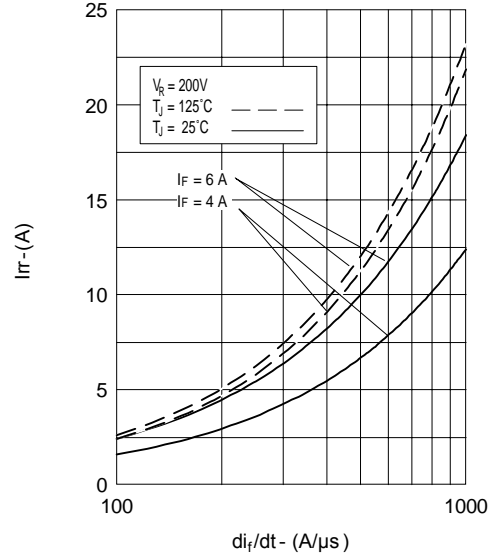

Fig. 6 - Typical Recovery Current Vs. di_f/dt

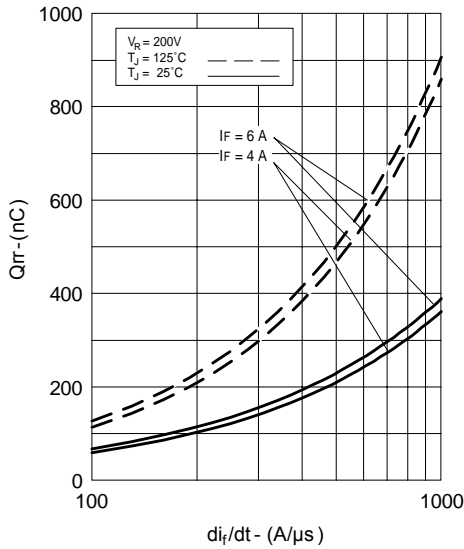

Fig. 8 - Typical Stored Charge vs. di_f/dt

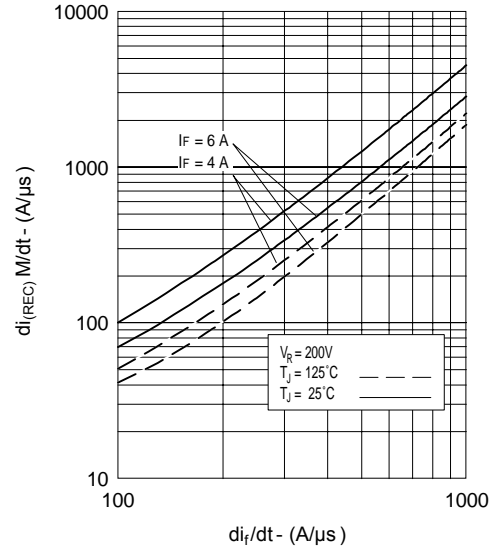

Fig. 7 - Typical $di_{(REC)} M/dt$ vs. di_f/dt

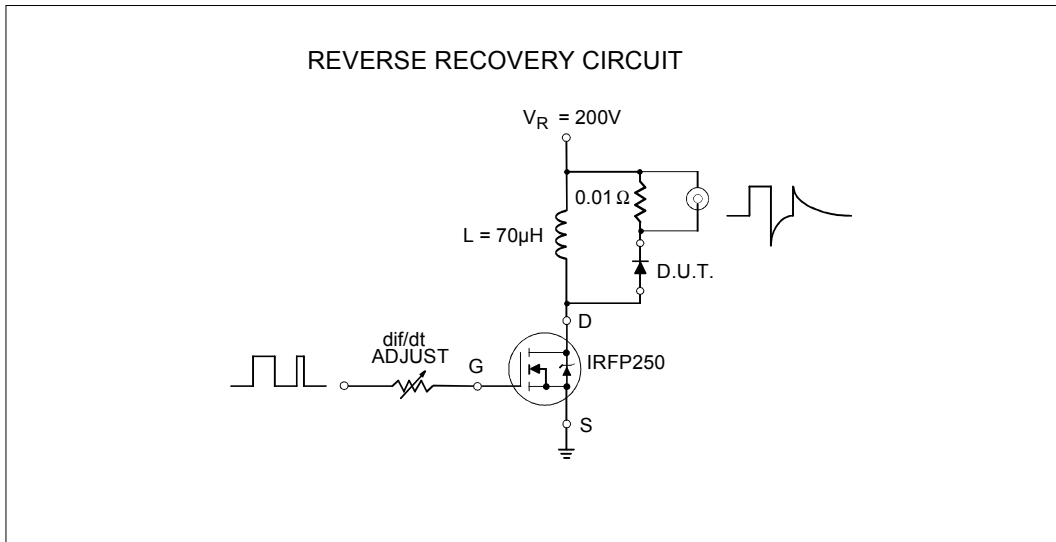

Fig. 9- Reverse Recovery Parameter Test Circuit

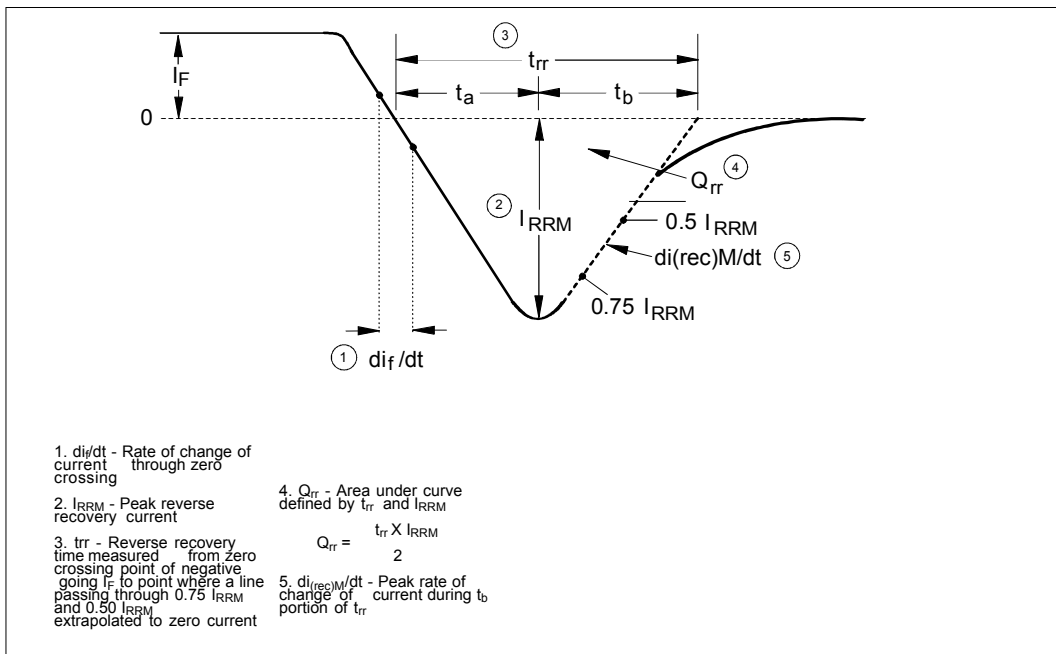
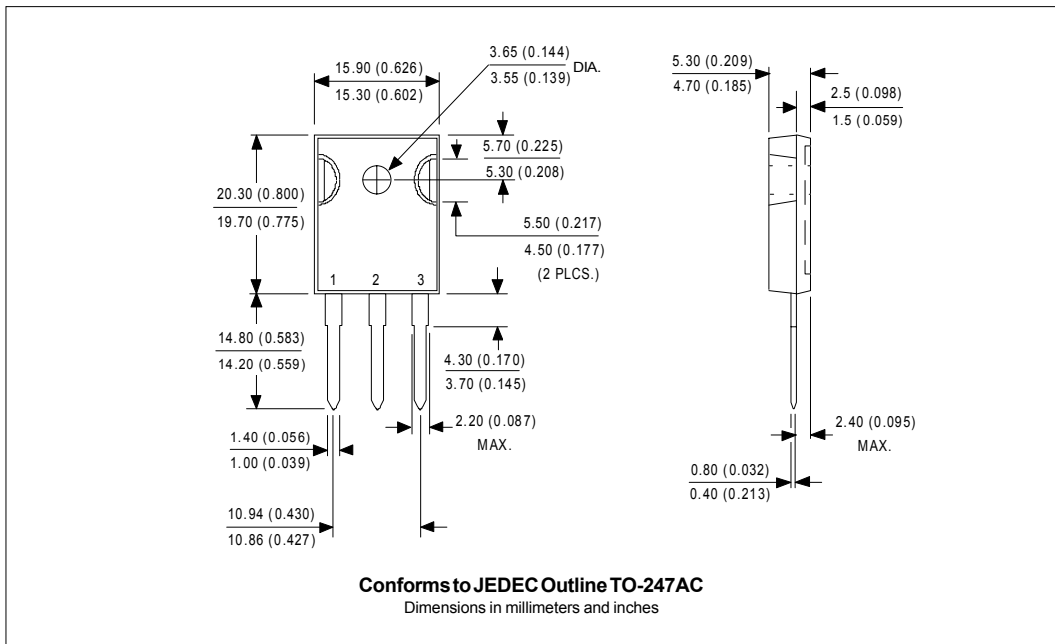

Fig. 10 - Reverse Recovery Waveform and Definitions

Outline Table



Ordering Information Table

Device Code					
HF	A	12	PA	120	C
①	②	③	④	⑤	⑥
1	- Hexfred Family				
2	- Process Designator				
	A = A subs. elec. irradi.				
	B = B subs. Platinum				
3	- Average Current: Code 12 = 12 AMPS				
4	- Package Outline: Code PA = TO-247 3 Lead				
5	- Voltage code : Code 120 = 1200 V				
6	- Configuration : Code C = Center Tap Common Cathode				

WORLD HEADQUARTERS: 233 Kansas St., El Segundo, California 90245 U.S.A. Tel: (310) 322 3331. Fax: (310) 322 3332.
EUROPEAN HEADQUARTERS: Hurst Green, Oxted, Surrey RH8 9BB, U.K. Tel: ++ 44 1883 732020. Fax: ++ 44 1883 733408.
IR CANADA: 15 Lincoln Court, Brampton, Markham, Ontario L6T3Z2. Tel: (905) 453 2200. Fax: (905) 475 8801.
IR GERMANY: Saalburgstrasse 157, 61350 Bad Homburg. Tel: ++ 49 6172 96590. Fax: ++ 49 6172 965933.
IR ITALY: Via Liguria 49, 10071 Borgaro, Torino. Tel: ++ 39 11 4510111. Fax: ++ 39 11 4510220.
IR FAR EAST: K&H Bldg., 2F, 30-4 Nishi-Ikebukuro 3-Chome, Toshima-Ku, Tokyo, Japan 171. Tel: 81 3 3983 0086.
IR SOUTHEAST ASIA: 1 Kim Seng Promenade, Great World City West Tower, 13-11, Singapore 237994. Tel: ++ 65 838 4630.
IR TAIWAN: 16 Fl. Suite D.207, Sec. 2, Tun Haw South Road, Taipei, 10673, Taiwan. Tel: 886 2 2377 9936.

<http://www.irf.com>

Fax-On-Demand: +44 1883 733420

Data and specifications subject to change without notice