

# International IOR Rectifier FRED

PD - 94324

## HFB50HI20

### Ultrafast, Soft Recovery Diode

#### Features

- Reduced RFI and EMI
- Reduced Snubbing
- Extensive Characterization of Recovery Parameters
- Hermetic

$$V_R = 200V$$

$$I_{F(AV)} = 50A$$

$$t_{rr} = 35ns$$

#### Description

These Ultrafast, soft recovery diodes are optimized to reduce losses and EMI/RFI in high frequency power conditioning systems. An extensive characterization of the recovery behavior for different values of current, temperature and di/dt simplifies the calculations of losses in the operating conditions. The softness of the recovery eliminates the need for a snubber in most applications. These devices are ideally suited for power converters, motors drives and other applications where switching losses are significant portion of the total losses.

#### Absolute Maximum Ratings

	Parameter	Max.	Units
$V_R$	Cathode to Anode Voltage	200	V
$I_{F(AV)}$	Continuous Forward Current, ① $T_C = 87^\circ C$	50	A
$I_{FSM}$	Single Pulse Forward Current, ② $T_C = 25^\circ C$	450	
$P_D @ T_C = 25^\circ C$	Maximum Power Dissipation	167	W
$T_J, T_{STG}$	Operating Junction and Storage Temperature Range	-55 to +150	$^\circ C$

**Note:** ① D.C. = 50% rect. wave  
 ② 1/2 sine wave, 60 Hz, P.W. = 8.33 ms

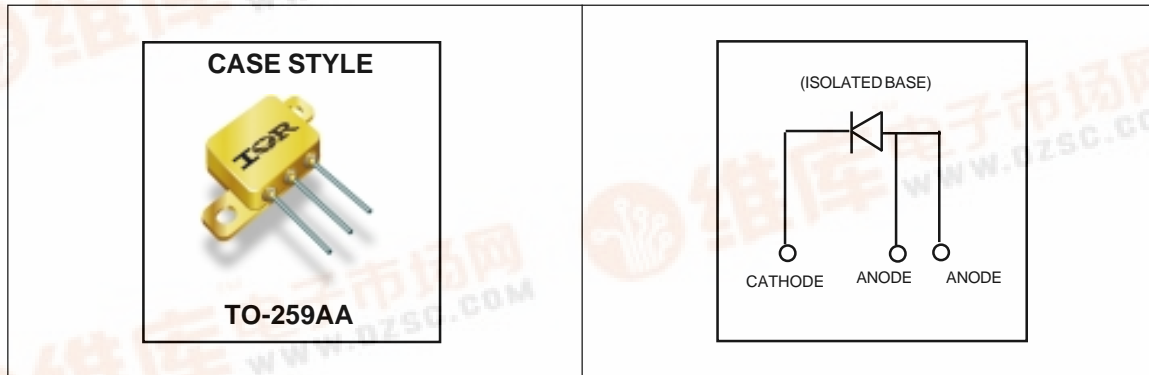

**Electrical Characteristics @ T<sub>J</sub> = 25°C (unless otherwise specified)**

	Parameter	Min.	Typ.	Max.	Units	Test Conditions
V <sub>BR</sub>	Cathode Anode Breakdown Voltage	200	—	—	V	I <sub>R</sub> = 100μA
V <sub>F</sub>	Forward Voltage See Fig. 1 ③	—	—	1.34	V	I <sub>F</sub> = 50A, T <sub>J</sub> = -55°C ④
		—	—	1.28		I <sub>F</sub> = 50A, T <sub>J</sub> = 25°C ④
		—	—	1.7		I <sub>F</sub> = 100A, T <sub>J</sub> = 25°C ④
		—	—	1.69		I <sub>F</sub> = 100A, T <sub>J</sub> = 125°C ④
I <sub>R</sub>	Reverse Leakage Current See Fig. 2 ③	—	—	0.07	μA	V <sub>R</sub> = V <sub>R</sub> Rated
		—	—	100	μA	V <sub>R</sub> = V <sub>R</sub> Rated, T <sub>J</sub> = 125°C
C <sub>T</sub>	Junction Capacitance, See Fig. 3	—	—	330	pF	V <sub>R</sub> = 200V
L <sub>S</sub>	Series Inductance	—	8.7	—	nH	Measured from anode lead to cathode lead, 6 mm ( 0.025 in ) from package

**Dynamic Recovery Characteristics @ T<sub>J</sub> = 25°C (unless otherwise specified)**

	Parameter	Min.	Typ.	Max.	Units	Test Conditions
t <sub>rr</sub>	Reverse Recovery Time	—	—	35	ns	I <sub>F</sub> = 0.5A, V <sub>R</sub> = 30V, di/dt = 300A/μs
t <sub>rr1</sub>	Reverse Recovery Time	—	42	—	ns	T <sub>J</sub> = 25°C See Fig. 5
t <sub>rr2</sub>		—	69	—		T <sub>J</sub> = 125°C
I <sub>RRM1</sub>	Peak Recovery Current	—	4.4	—	A	T <sub>J</sub> = 25°C See Fig. 6
I <sub>RRM2</sub>		—	8.7	—		T <sub>J</sub> = 125°C
Q <sub>rr1</sub>	Reverse Recovery Charge	—	108	—	nC	T <sub>J</sub> = 25°C See Fig. 7
Q <sub>rr2</sub>		—	314	—		T <sub>J</sub> = 125°C
di <sub>(rec)M</sub> /dt1	Peak Rate of Fall of Recovery Current During t <sub>b</sub>	—	390	—	A/μs	T <sub>J</sub> = 25°C See Fig. 8
di <sub>(rec)M</sub> /dt2		—	570	—		T <sub>J</sub> = 125°C

**Thermal - Mechanical Characteristics**

	Parameter	Typ.	Max.	Units
R <sub>thJC</sub>	Junction-to-Case	—	0.75	°C/W
Wt	Weight	10.9	—	g

Note:

③ Pulse Width &lt; 300μs, Duty Cycle &lt; 2%

④ Pins 2 and 3 externally tied together

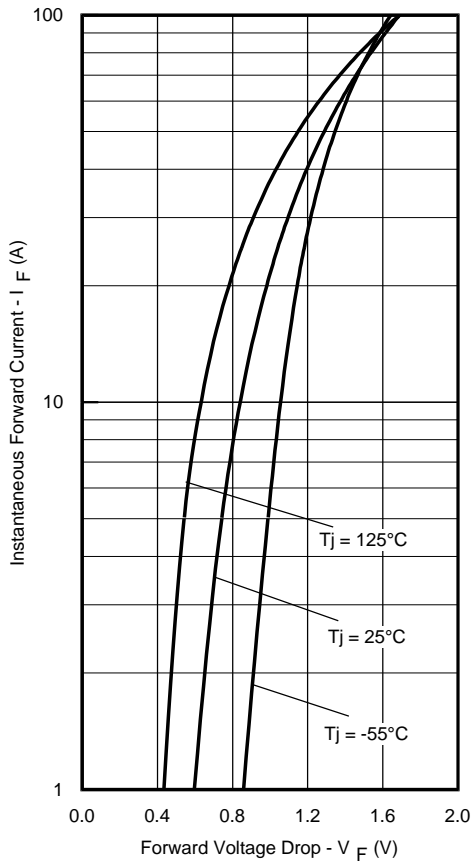

**Fig. 1** - Maximum Forward Voltage Drop Vs. Instantaneous Forward Current

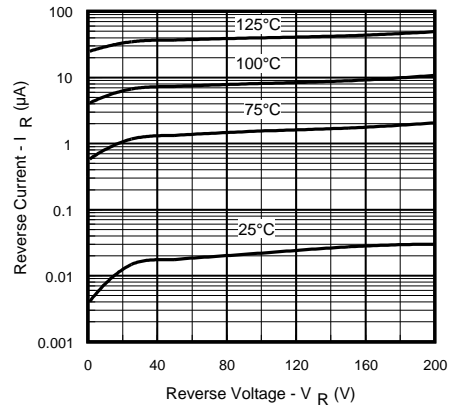

**Fig. 2** - Typical Reverse Current Vs. Reverse Voltage

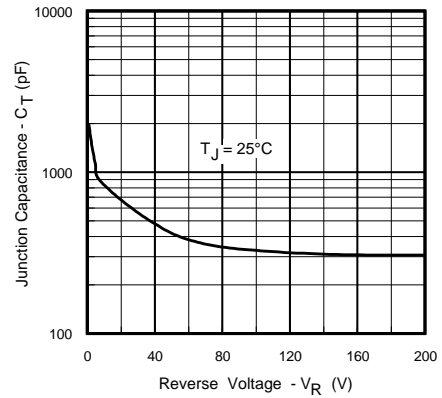

**Fig. 3** - Typical Junction Capacitance Vs. Reverse Voltage

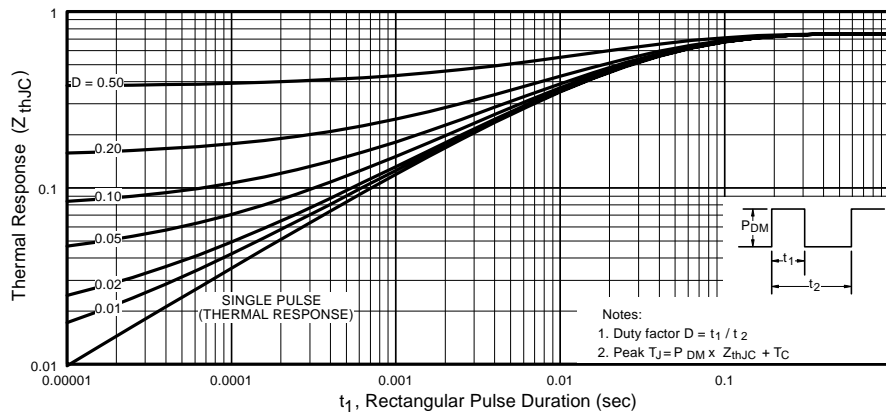

**Fig. 4** - Maximum Thermal Impedance  $Z_{thJC}$  Characteristics

# HFB50HI20

International  
**IR** Rectifier

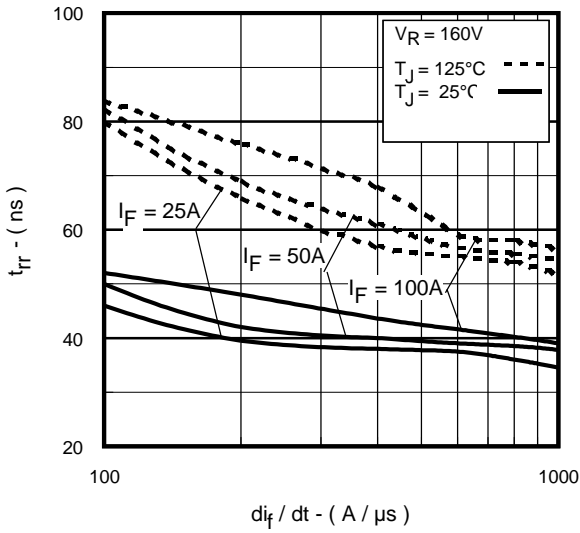

Fig. 5 - Typical Reverse Recovery Vs.  $di_f/dt$ ,

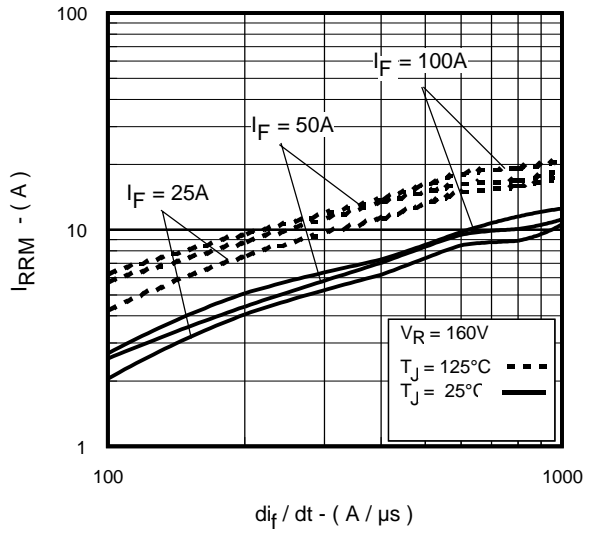

Fig. 6 - Typical Recovery Current Vs.  $di_f/dt$ ,

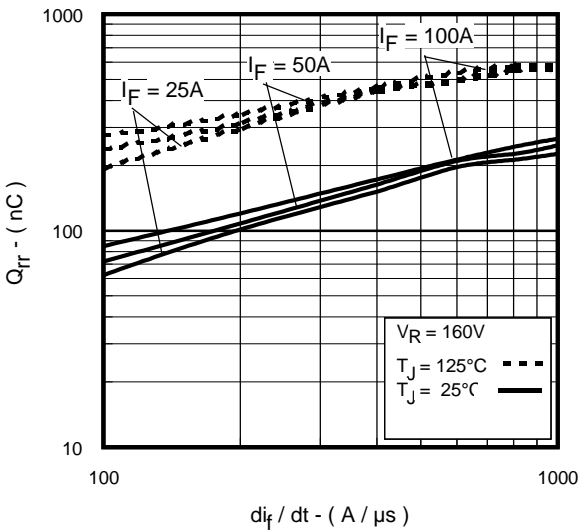

Fig. 7 - Typical Stored Charge Vs.  $di_f/dt$

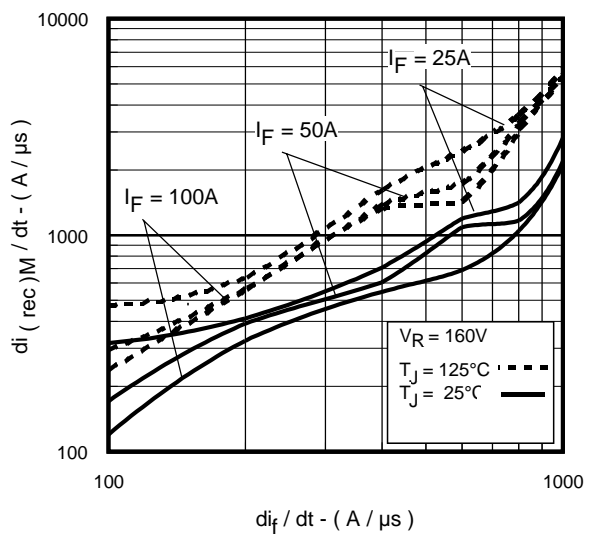
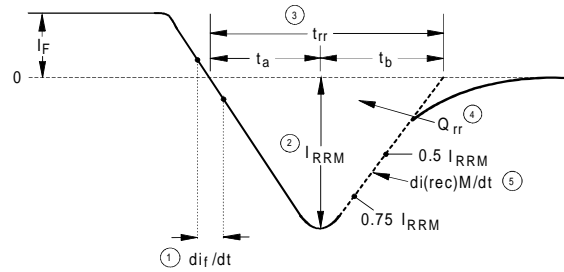
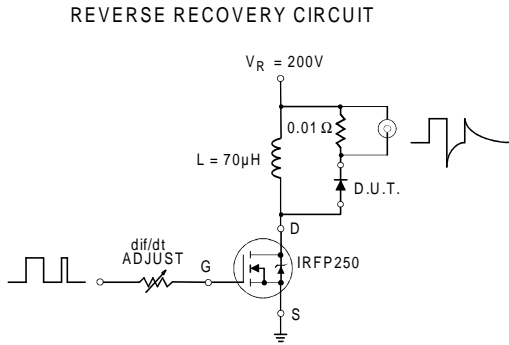

Fig. 8 - Typical  $di_{(rec)M}/dt$  Vs.  $di_f/dt$



- $di/dt$  - Rate of change of current through zero crossing
- $I_{RRM}$  - Peak reverse recovery current
- $t_{rr}$  - Reverse recovery time measured from zero crossing point of negative going  $I_F$  to point where a line passing through  $0.75 I_{RRM}$  and  $0.50 I_{RRM}$  extrapolated to zero current
- $Q_{rr}$  - Area under curve defined by  $t_{rr}$  and  $I_{RRM}$
- $di(rec)/dt$  - Peak rate of change of current during  $t_b$  portion of  $t_{rr}$

$$Q_{rr} = \frac{t_{rr} \times I_{RRM}}{2}$$

Fig. 9 - Reverse Recovery Parameter Test Circuit

Fig. 10 - Reverse Recovery Waveform and Definitions

Case Outline and Dimensions — TO-259AA

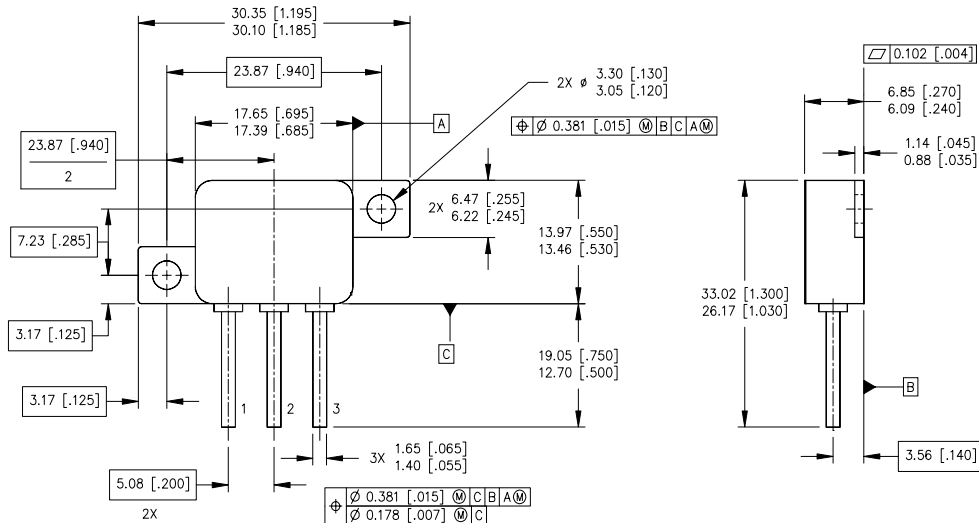

NOTES:

- DIMENSIONING AND TOLERANCING PER ASME 14.5M-1994.
- DIMENSIONS ARE SHOWN IN MILLIMETERS [INCHES].
- CONTROLLING DIMENSION: INCH
- CONFORMS TO JEDEC OUTLINE TO-259AA.

PIN ASSIGNMENTS

- 1 = CATHODE
- 2 = ANODE
- 3 = ANODE