

International IR Rectifier FRED

PD - 94067C

HFB60HF20

Ultrafast, Soft Recovery Diode

Features

- Reduced RFI and EMI
- Reduced Snubbing
- Extensive Characterization of Recovery Parameters
- Hermetic
- Surface Mount

$V_R = 200V$
$I_{F(AV)} = 60A$
$t_{rr} = 35ns$

Description

These Ultrafast, soft recovery diodes are optimized to reduce losses and EMI/RFI in high frequency power conditioning systems. An extensive characterization of the recovery behavior for different values of current, temperature and di/dt simplifies the calculations of losses in the operating conditions. The softness of the recovery eliminates the need for a snubber in most applications. These devices are ideally suited for power converters, motors drives and other applications where switching losses are significant portion of the total losses.

Absolute Maximum Ratings

	Parameter	Max.	Units
V_R	Cathode to Anode Voltage	200	V
$I_{F(AV)}$	Continuous Forward Current, ① $T_C = 55^\circ C$	60	A
I_{FSM}	Single Pulse Forward Current, ② $T_C = 25^\circ C$	500	
$P_D @ T_C = 25^\circ C$	Maximum Power Dissipation	70	W
T_J, T_{STG}	Operating Junction and Storage Temperature Range	-55 to +150	$^\circ C$

Note: ① D.C. = 50% rect. wave
 ② 1/2 sine wave, 60 Hz , P.W. = 8.33 ms

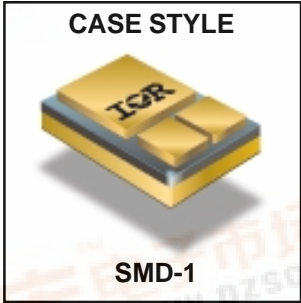
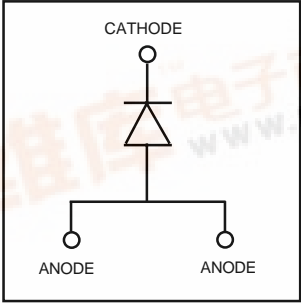
<p>CASE STYLE</p>  <p>SMD-1</p>	
--	--



Electrical Characteristics @ T_J = 25°C (unless otherwise specified)

	Parameter	Min.	Typ.	Max.	Units	Test Conditions
V _{BR}	Cathode Anode Breakdown Voltage	200	—	—	V	I _R = 100μA
V _F	Forward Voltage See Fig. 1	—	—	1.15	V	I _F = 30A, T _J = -55°C
		—	—	0.97		I _F = 30A, T _J = 25°C
		—	—	1.08		I _F = 60A, T _J = 25°C
		—	—	1.30		I _F = 120A, T _J = 25°C
		—	—	0.8		I _F = 30A, T _J = 125°C
I _R	Reverse Leakage Current See Fig. 2	—	—	50	μA	V _R = V _R Rated
		—	—	1.0	mA	V _R = V _R Rated, T _J = 125°C
C _T	Junction Capacitance, See Fig. 3	—	—	190	pF	V _R = 200V
L _S	Series Inductance	—	5.9	—	nH	Measured from center of cathode pad to center of anode pad

Dynamic Recovery Characteristics @ T_J = 25°C (unless otherwise specified)

	Parameter	Min.	Typ.	Max.	Units	Test Conditions
t _{rr}	Reverse Recovery Time	—	—	35	ns	I _F = 1.0A, V _R = 30V, di/dt = 300A/μs
t _{rr1}	Reverse Recovery Time	—	45	—	ns	T _J = 25°C See Fig.
t _{rr2}		—	71	—		T _J = 125°C 5
I _{RRM1}	Peak Recovery Current	—	5.3	—	A	T _J = 25°C See Fig.
I _{RRM2}		—	10.3	—		T _J = 125°C 6
Q _{rr1}	Reverse Recovery Charge	—	120	—	nC	T _J = 25°C See Fig.
Q _{rr2}		—	366	—		T _J = 125°C 7
di _{(rec)M} /dt1	Peak Rate of Fall of Recovery Current During t _b	—	590	—	A/μs	T _J = 25°C See Fig.
di _{(rec)M} /dt2		—	1290	—		T _J = 125°C 8

Thermal - Mechanical Characteristics

	Parameter	Typ.	Max.	Units
R _{thJC}	Junction-to-Case	—	1.76	°C/W
Wt	Weight	2.6	—	g

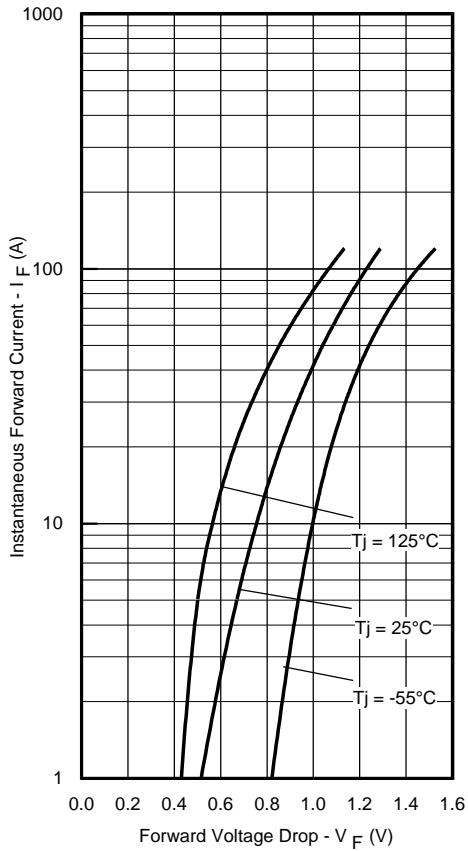

Fig. 1 - Maximum Forward Voltage Drop Vs. Instantaneous Forward Current

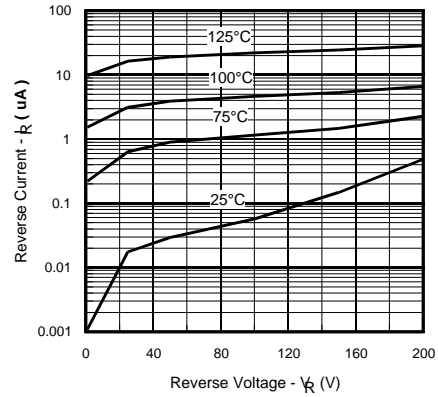

Fig. 2 - Typical Reverse Current Vs. Reverse Voltage

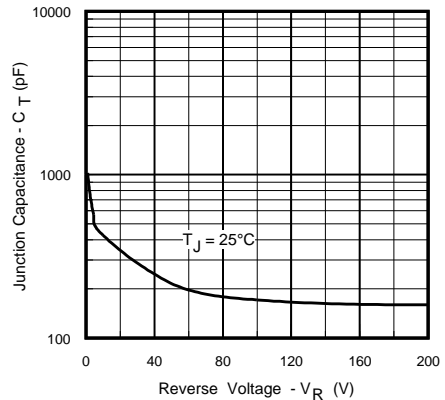

Fig. 3 - Typical Junction Capacitance Vs. Reverse Voltage

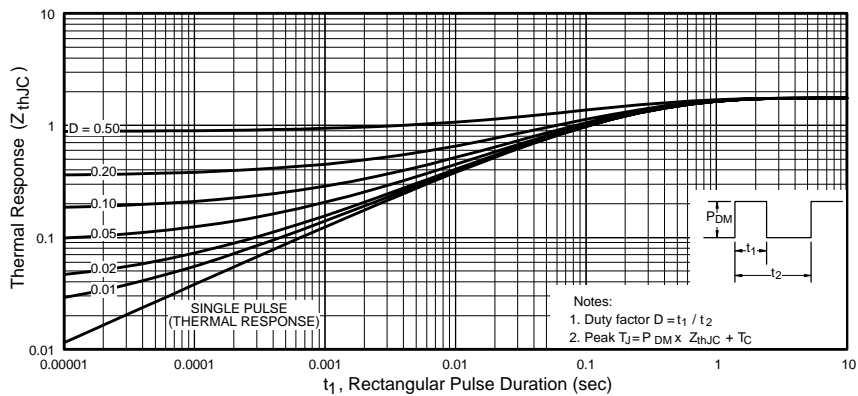

Fig. 4 - Maximum Thermal Impedance Z_{thjC} Characteristics

HFB60HF20

International
IR Rectifier

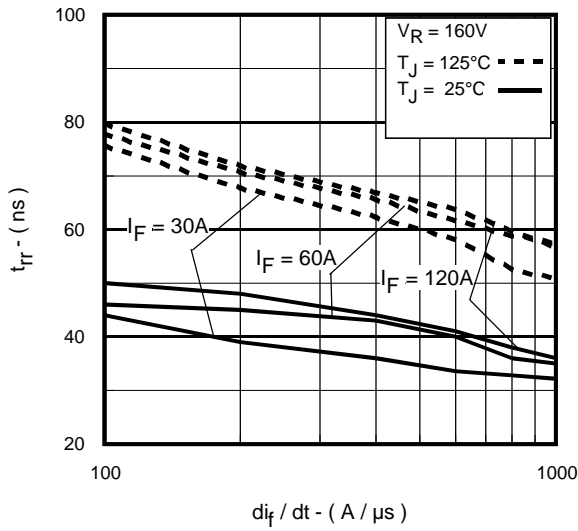

Fig. 5 - Typical Reverse Recovery Vs. di_f/dt ,

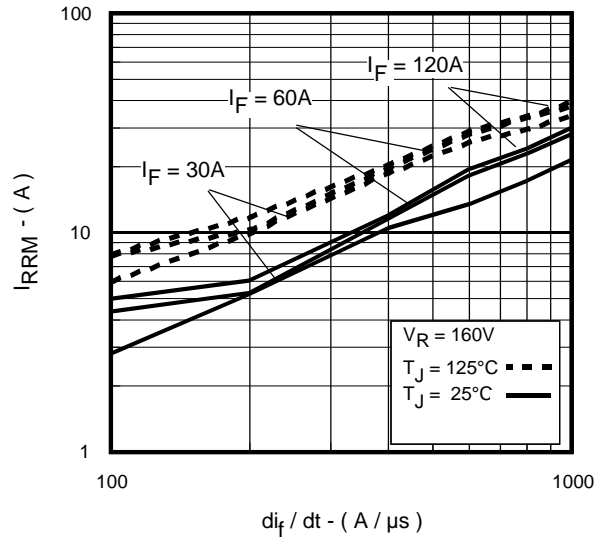

Fig. 6 - Typical Recovery Current Vs. di_f/dt ,

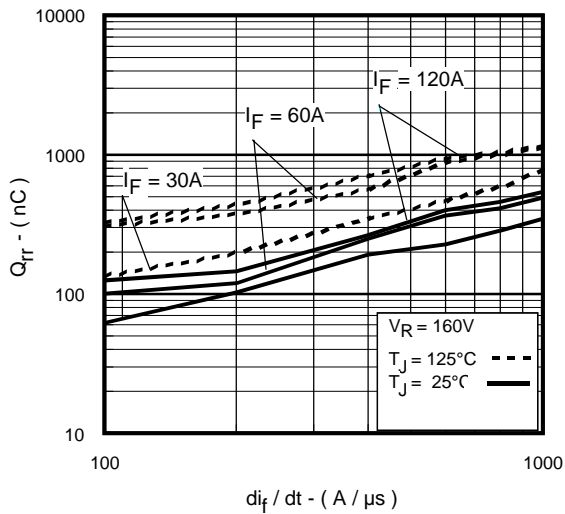

Fig. 7 - Typical Stored Charge Vs. di_f/dt

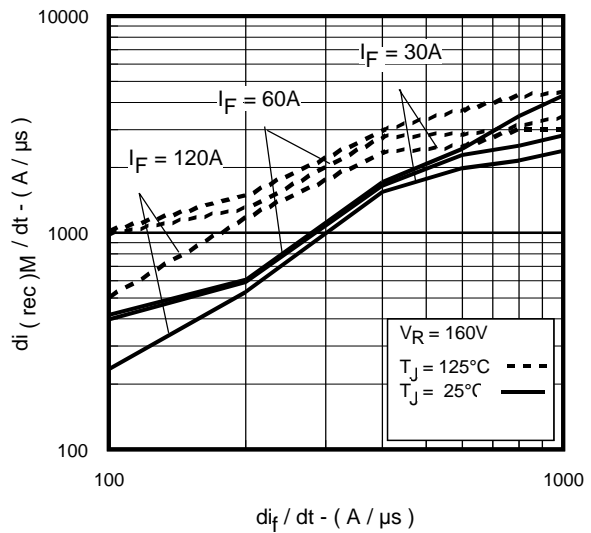
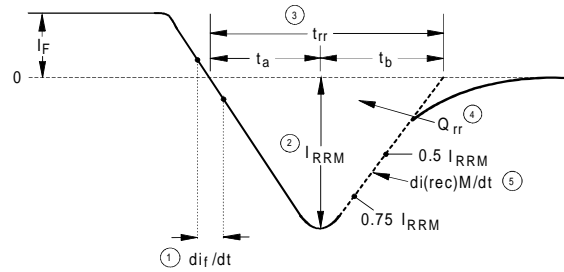
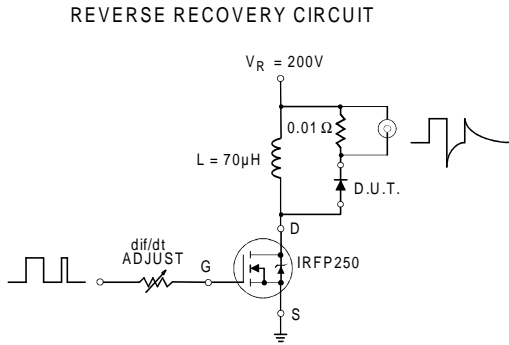

Fig. 8 - Typical $di_{(rec)M}/dt$ Vs. di_f/dt



1. di/dt - Rate of change of current through zero crossing
2. I_{RRM} - Peak reverse recovery current
3. t_{rr} - Reverse recovery time measured from zero crossing point of negative going I_F to point where a line passing through $0.75 I_{RRM}$ and $0.50 I_{RRM}$ extrapolated to zero current
4. Q_{rr} - Area under curve defined by t_{rr} and I_{RRM}

$$Q_{rr} = \frac{t_{rr} \times I_{RRM}}{2}$$
5. $di_{(rec)M}/dt$ - Peak rate of change of current during t_b portion of t_{rr}

Fig. 9 - Reverse Recovery Parameter Test Circuit

Fig. 10 - Reverse Recovery Waveform and Definitions

Case Outline and Dimensions — SMD-1

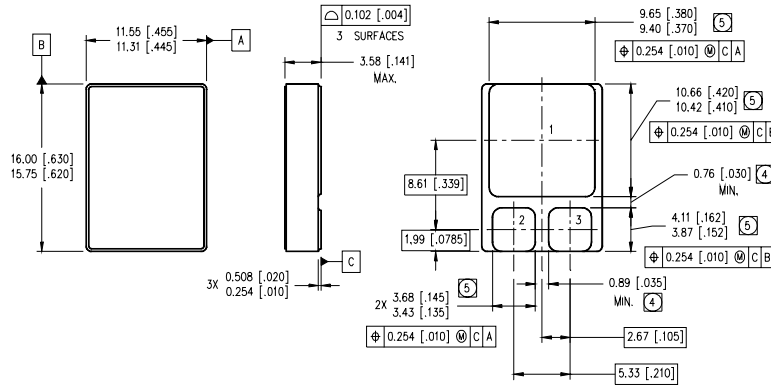

NOTES:

1. DIMENSIONING & TOLERANCING PER ASME Y14.5M-1994.
2. CONTROLLING DIMENSION: INCH.
3. DIMENSIONS ARE SHOWN IN MILLIMETERS [INCHES].
4. DIMENSION INCLUDES METALLIZATION FLASH.
5. DIMENSION DOES NOT INCLUDE METALLIZATION FLASH.

PAD ASSIGNMENTS

- 1 = CATHODE
- 2 = COMMON ANODE
- 3 = COMMON ANODE