

# International IR Rectifier FRED

PD - 94228A

## HFB60HF20C

Ultrafast, Soft Recovery Diode

### Features

- Reduced RFI and EMI
- Reduced Snubbing
- Extensive Characterization of Recovery Parameters
- Hermetic
- Surface Mount

$V_R = 200V$
$I_{F(AV)} = 60A$
$t_{rr} = 35ns$

### Description

These Ultrafast, soft recovery diodes are optimized to reduce losses and EMI/RFI in high frequency power conditioning systems. An extensive characterization of the recovery behavior for different values of current, temperature and di/dt simplifies the calculations of losses in the operating conditions. The softness of the recovery eliminates the need for a snubber in most applications. These devices are ideally suited for power converters, motors drives and other applications where switching losses are significant portion of the total losses.

### Absolute Maximum Ratings

	Parameter	Max.	Units
$V_R$	Cathode to Anode Voltage ( Per Leg )	200	V
$I_{F(AV)}$	Continuous Forward Current, ① $T_C = 50^\circ C$	60	A
$I_{FSM}$	Single Pulse Forward Current, ② $T_C = 25^\circ C$ ( Per Leg )	300	
$P_D @ T_C = 25^\circ C$	Maximum Power Dissipation	46	W
$T_J, T_{STG}$	Operating Junction and Storage Temperature Range	-55 to +150	$^\circ C$

**Note:** ① D.C. = 50% rect. wave  
 ② 1/2 sine wave, 60 Hz , P.W. = 8.33 ms

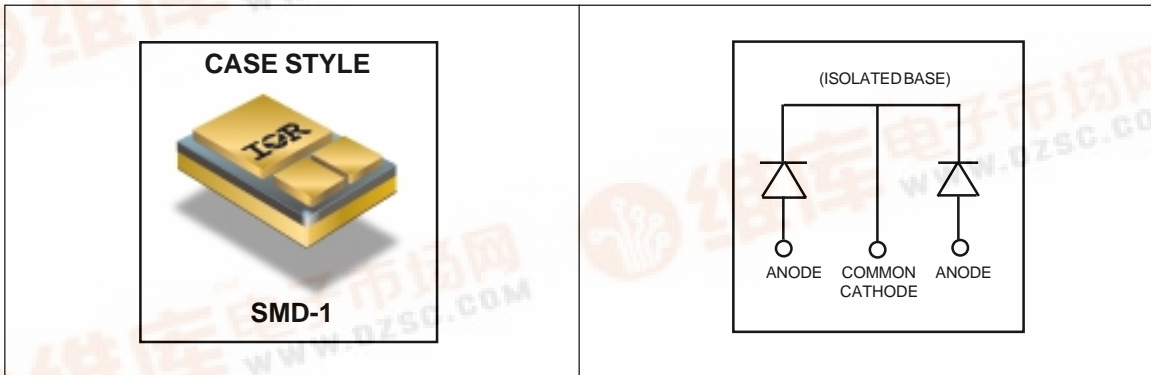

**Electrical Characteristics ( Per Leg ) @ T<sub>J</sub> = 25°C (unless otherwise specified)**

	Parameter	Min.	Typ.	Max.	Units	Test Conditions
V <sub>BR</sub>	Cathode Anode Breakdown Voltage	200	—	—	V	I <sub>R</sub> = 100μA
V <sub>F</sub>	Forward Voltage See Fig. 1	—	—	1.19	V	I <sub>F</sub> = 30A, T <sub>J</sub> = -55°C
		—	—	1.08		I <sub>F</sub> = 30A, T <sub>J</sub> = 25°C
		—	—	1.25		I <sub>F</sub> = 60A, T <sub>J</sub> = 25°C
		—	—	1.22		I <sub>F</sub> = 60A, T <sub>J</sub> = 125°C
I <sub>R</sub>	Reverse Leakage Current See Fig. 2	—	—	10	μA	V <sub>R</sub> = V <sub>R</sub> Rated
		—	—	100	μA	V <sub>R</sub> = V <sub>R</sub> Rated, T <sub>J</sub> = 125°C
C <sub>T</sub>	Junction Capacitance, See Fig. 3	—	—	140	pF	V <sub>R</sub> = 200V
L <sub>S</sub>	Series Inductance	—	5.9	—	nH	Measured from center of cathode pad to center of anode pad

**Dynamic Recovery Characteristics ( Per Leg ) @ T<sub>J</sub> = 25°C (unless otherwise specified)**

	Parameter	Min.	Typ.	Max.	Units	Test Conditions
t <sub>rr</sub>	Reverse Recovery Time	—	—	35	ns	I <sub>F</sub> = 1.0A, V <sub>R</sub> = 30V, di/dt = 200A/μs
t <sub>rr1</sub>	Reverse Recovery Time	—	35	—	ns	T <sub>J</sub> = 25°C See Fig. 5
t <sub>rr2</sub>		—	58	—		T <sub>J</sub> = 125°C
I <sub>R</sub> RM1	Peak Recovery Current	—	3.8	—	A	T <sub>J</sub> = 25°C See Fig. 6
I <sub>R</sub> RM2		—	8.0	—		T <sub>J</sub> = 125°C
Q <sub>rr1</sub>	Reverse Recovery Charge	—	77	—	nC	T <sub>J</sub> = 25°C See Fig. 7
Q <sub>rr2</sub>		—	240	—		T <sub>J</sub> = 125°C
di <sub>(rec)</sub> M/dt1	Peak Rate of Fall of Recovery Current During t <sub>b</sub>	—	470	—	A/μs	T <sub>J</sub> = 25°C See Fig. 8
di <sub>(rec)</sub> M/dt2		—	640	—		T <sub>J</sub> = 125°C

**Thermal - Mechanical Characteristics**

	Parameter	Typ.	Max.	Units
R <sub>thJC</sub>	Junction-to-Case, Single Leg Conducting	—	2.73	°C/W
Wt	Weight	2.6	—	g

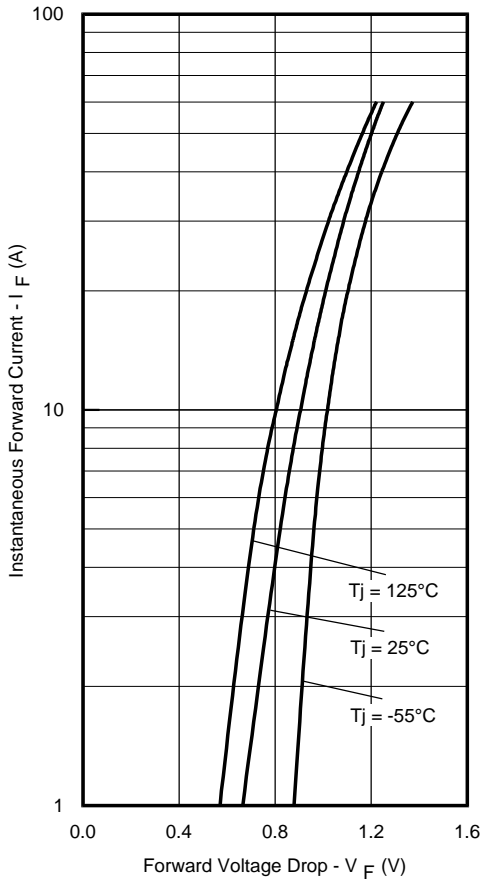

**Fig. 1** - Maximum Forward Voltage Drop Vs. Instantaneous Forward Current ( Per Leg )

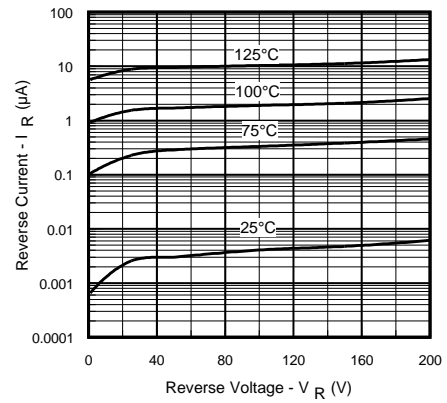

**Fig. 2** - Typical Reverse Current Vs. Reverse Voltage ( Per Leg )

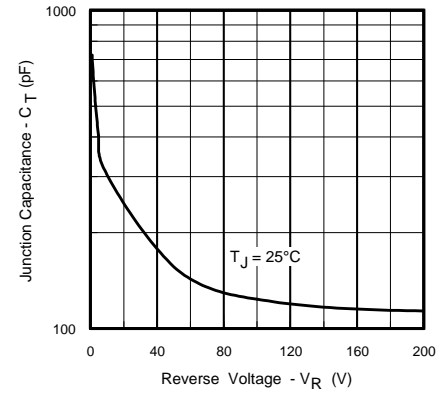

**Fig. 3** - Typical Junction Capacitance Vs. Reverse Voltage ( Per Leg )

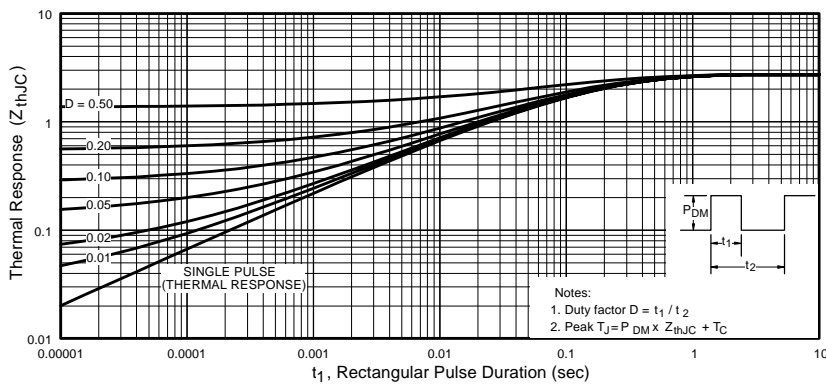

**Fig. 4** - Maximum Thermal Impedance  $Z_{th(jc)}$  Characteristics ( Per Leg )

# HFB60HF20C

International  
**IR** Rectifier

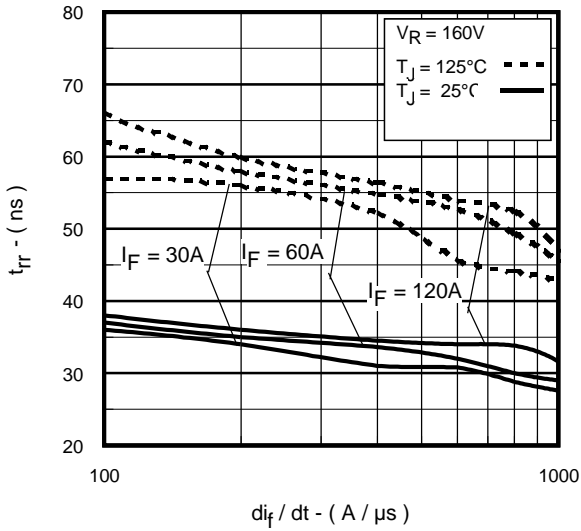

Fig. 5 - Typical Reverse Recovery Vs.  $di_f/dt$  ( Per Leg )

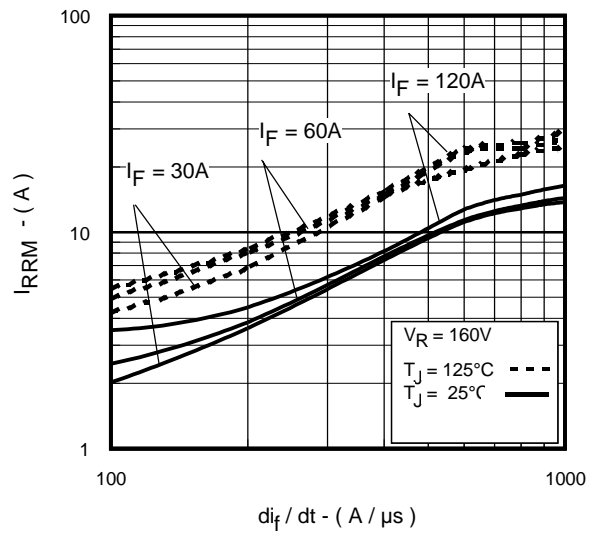

Fig. 6 - Typical Recovery Current Vs.  $di_f/dt$  ( Per Leg )

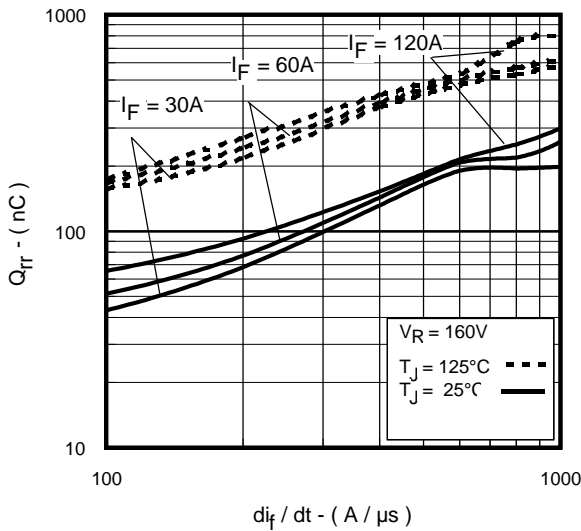

Fig. 7 - Typical Stored Charge Vs.  $di_f/dt$  ( Per Leg )

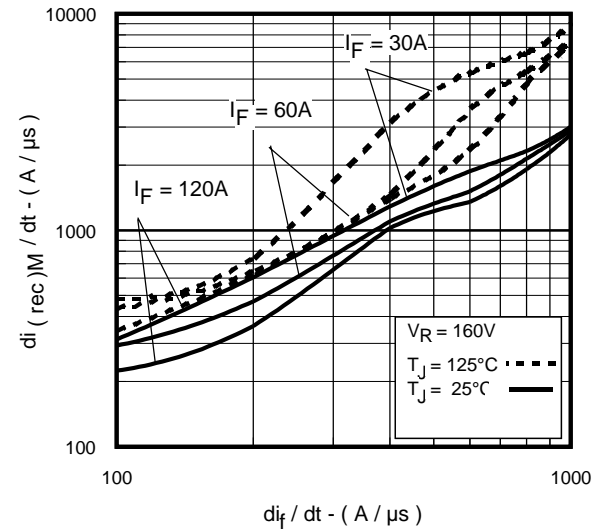
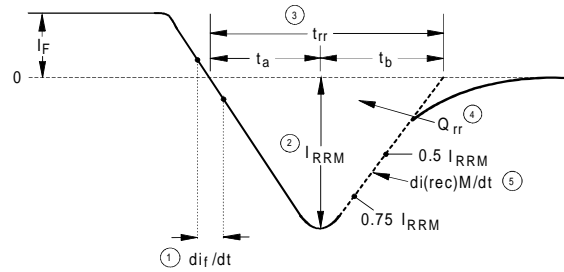
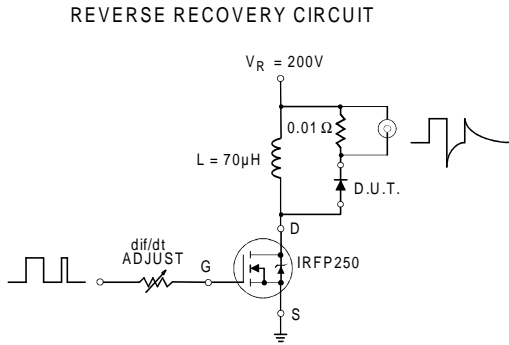

Fig. 8 - Typical  $di_{(rec)M}/dt$  Vs.  $di_f/dt$  ( Per Leg )



1.  $di/dt$  - Rate of change of current through zero crossing
2.  $I_{RRM}$  - Peak reverse recovery current
3.  $t_{rr}$  - Reverse recovery time measured from zero crossing point of negative going  $I_F$  to point where a line passing through  $0.75 I_{RRM}$  and  $0.50 I_{RRM}$  extrapolated to zero current
4.  $Q_{rr}$  - Area under curve defined by  $t_{rr}$  and  $I_{RRM}$   

$$Q_{rr} = \frac{t_{rr} \times I_{RRM}}{2}$$
5.  $di(\text{rec})M/dt$  - Peak rate of change of current during  $t_b$  portion of  $t_{rr}$

Fig. 9 - Reverse Recovery Parameter Test Circuit

Fig. 10 - Reverse Recovery Waveform and Definitions

**Case Outline and Dimensions — SMD-1**

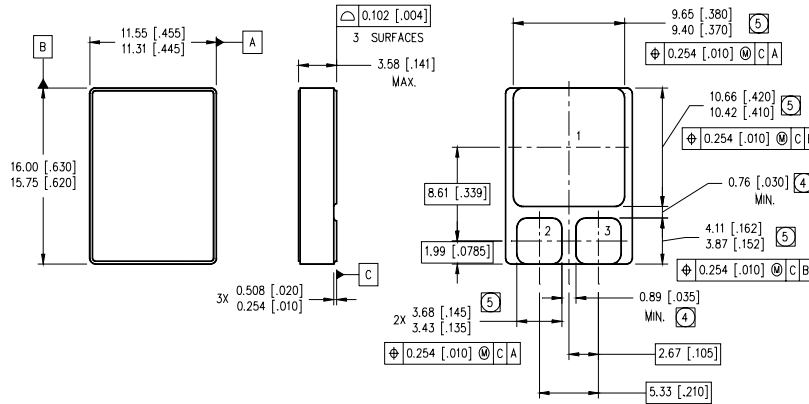

NOTES:

1. DIMENSIONING & TOLERANCING PER ASME Y14.5M-1994.
2. CONTROLLING DIMENSION: INCH.
3. DIMENSIONS ARE SHOWN IN MILLIMETERS [INCHES].
4. DIMENSION INCLUDES METALLIZATION FLASH.
5. DIMENSION DOES NOT INCLUDE METALLIZATION FLASH.

PAD ASSIGNMENTS

- 1 = COMMON CATHODE
- 2 = ANODE 1
- 3 = ANODE 2