

International
IRF Rectifier

PD - 94297

SMPS MOSFET

IRF6216

HEXFET® Power MOSFET

Applications

- Reset Switch for Active Clamp Reset DC-DC converters

V_{DSS}	R_{DS(on)} max	I_D
-150V	0.240Ω @ V_{GS} = -10V	-2.2A

Benefits

- Low Gate to Drain Charge to Reduce Switching Losses
- Fully Characterized Capacitance Including Effective C_{oss} to Simplify Design (See App. Note AN1001)
- Fully Characterized Avalanche Voltage and Current

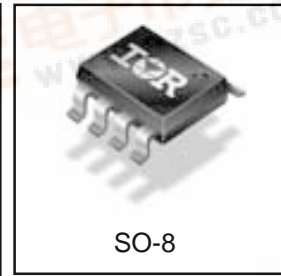
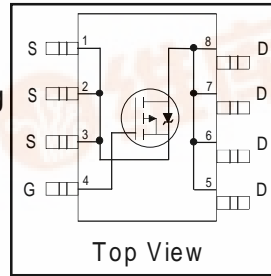

Absolute Maximum Ratings

	Parameter	Max.	Units
I _D @ T _A = 25°C	Continuous Drain Current, V _{GS} @ 10V	-2.2	A
I _D @ T _A = 70°C	Continuous Drain Current, V _{GS} @ 10V	-1.9	
I _{DM}	Pulsed Drain Current ①	-19	
P _D @ T _A = 25°C	Power Dissipation②	2.5	W
	Linear Derating Factor	0.02	W/°C
V _{GS}	Gate-to-Source Voltage	± 20	V
dv/dt	Peak Diode Recovery dv/dt	7.8	V/ns
T _J	Operating Junction and	-55 to + 150	°C
T _{STG}	Storage Temperature Range		
	Soldering Temperature, for 10 seconds	300 (1.6mm from case)	

Thermal Resistance

Symbol	Parameter	Typ.	Max.	Units
R _{θJL}	Junction-to-Drain Lead	—	20	°C/W
R _{θJA}	Junction-to-Ambient ④	—	50	

Notes ① through ④ are on page 8
www.irf.com



IRF6216

International
IR Rectifier

Static @ $T_J = 25^\circ\text{C}$ (unless otherwise specified)

	Parameter	Min.	Typ.	Max.	Units	Conditions
$V_{(BR)DSS}$	Drain-to-Source Breakdown Voltage	-150	—	—	V	$V_{GS} = 0V, I_D = -250\mu A$
$\Delta V_{(BR)DSS}/\Delta T_J$	Breakdown Voltage Temp. Coefficient	—	-0.17	—	V/ $^\circ\text{C}$	Reference to 25°C , $I_D = -1\text{mA}$ ③
$R_{DS(on)}$	Static Drain-to-Source On-Resistance	—	—	0.240	Ω	$V_{GS} = -10V, I_D = -1.3A$ ③
$V_{GS(th)}$	Gate Threshold Voltage	-3.0	—	-5.0	V	$V_{DS} = V_{GS}, I_D = -250\mu A$
I_{DSS}	Drain-to-Source Leakage Current	—	—	-25	μA	$V_{DS} = -150V, V_{GS} = 0V$
		—	—	-250		$V_{DS} = -120V, V_{GS} = 0V, T_J = 125^\circ\text{C}$
I_{GSS}	Gate-to-Source Forward Leakage	—	—	-100	nA	$V_{GS} = -20V$
	Gate-to-Source Reverse Leakage	—	—	100		$V_{GS} = 20V$

Dynamic @ $T_J = 25^\circ\text{C}$ (unless otherwise specified)

	Parameter	Min.	Typ.	Max.	Units	Conditions
g_{fs}	Forward Transconductance	2.7	—	—	S	$V_{DS} = -50V, I_D = -1.3A$
Q_g	Total Gate Charge	—	33	49	nC	$I_D = -1.3A$
Q_{gs}	Gate-to-Source Charge	—	7.2	11		$V_{DS} = -120V$
Q_{gd}	Gate-to-Drain ("Miller") Charge	—	15	23		$V_{GS} = -10V,$
$t_{d(on)}$	Turn-On Delay Time	—	18	—		$V_{DD} = -75V$
t_r	Rise Time	—	15	—	ns	$I_D = -1.3A$
$t_{d(off)}$	Turn-Off Delay Time	—	33	—		$R_G = 6.5\Omega$
t_f	Fall Time	—	26	—		$V_{GS} = -10V$ ③
C_{iss}	Input Capacitance	—	1280	—	pF	$V_{GS} = 0V$
C_{oss}	Output Capacitance	—	220	—		$V_{DS} = -25V$
C_{rSS}	Reverse Transfer Capacitance	—	53	—		$f = 1.0\text{MHz}$
C_{oss}	Output Capacitance	—	1290	—		$V_{GS} = 0V, V_{DS} = -1.0V, f = 1.0\text{MHz}$
C_{oss}	Output Capacitance	—	99	—		$V_{GS} = 0V, V_{DS} = -120V, f = 1.0\text{MHz}$
$C_{oss\ eff.}$	Effective Output Capacitance	—	220	—		$V_{GS} = 0V, V_{DS} = 0V\ \text{to}\ -120V$

Avalanche Characteristics

	Parameter	Typ.	Max.	Units
E_{AS}	Single Pulse Avalanche Energy②	—	200	mJ
I_{AR}	Avalanche Current①	—	-4.0	A

Diode Characteristics

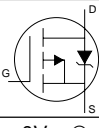
	Parameter	Min.	Typ.	Max.	Units	Conditions
I_S	Continuous Source Current (Body Diode)	—	—	-2.2	A	MOSFET symbol showing the integral reverse p-n junction diode. 
I_{SM}	Pulsed Source Current (Body Diode) ①	—	—	-19		
V_{SD}	Diode Forward Voltage	—	—	-1.6	V	$T_J = 25^\circ\text{C}, I_S = -1.3A, V_{GS} = 0V$ ③
t_{rr}	Reverse Recovery Time	—	80	120	nS	$T_J = 25^\circ\text{C}, I_F = -1.3A$
Q_{rr}	Reverse Recovery Charge	—	310	460	nC	$di/dt = -100A/\mu s$ ③

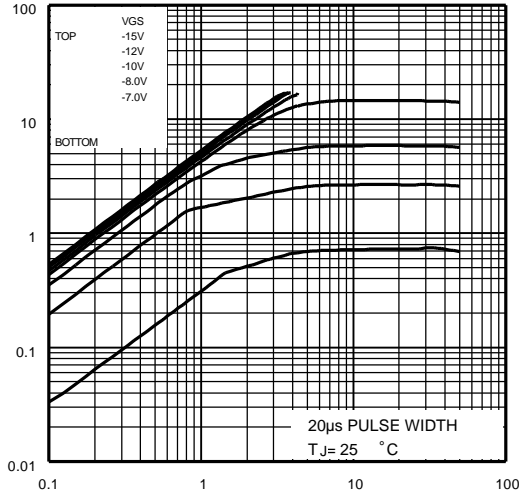

Fig 1. Typical Output Characteristics

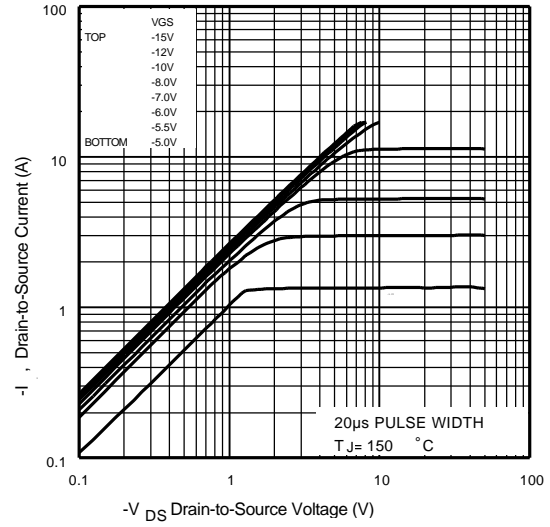

Fig 2. Typical Output Characteristics

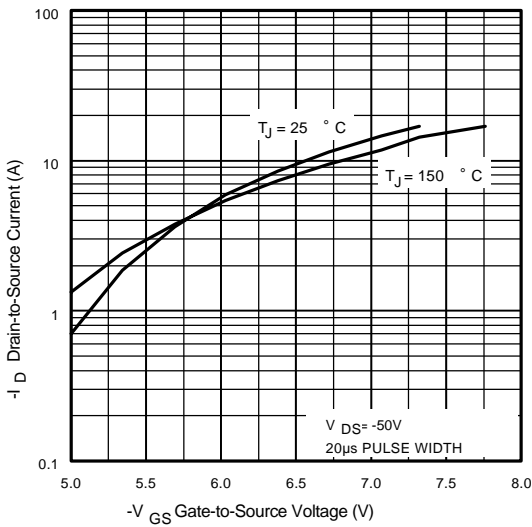

Fig 3. Typical Transfer Characteristics

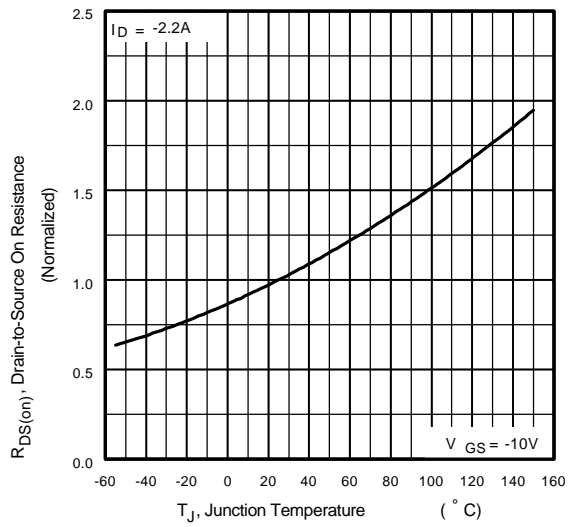

Fig 4. Normalized On-Resistance Vs. Temperature

IRF6216

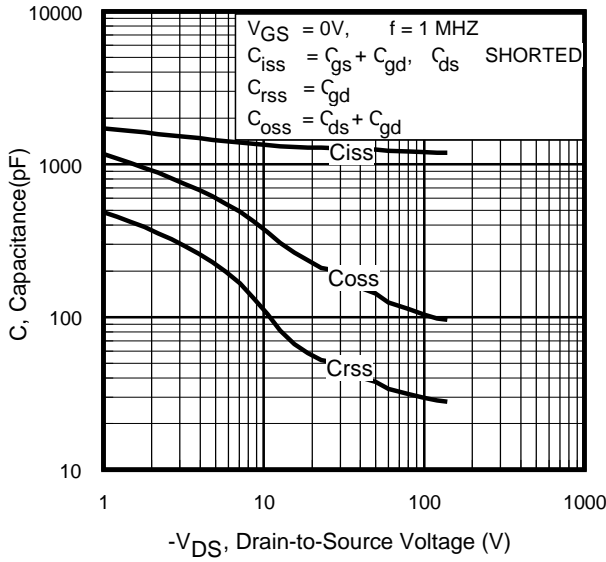

Fig 5. Typical Capacitance Vs. Drain-to-Source Voltage

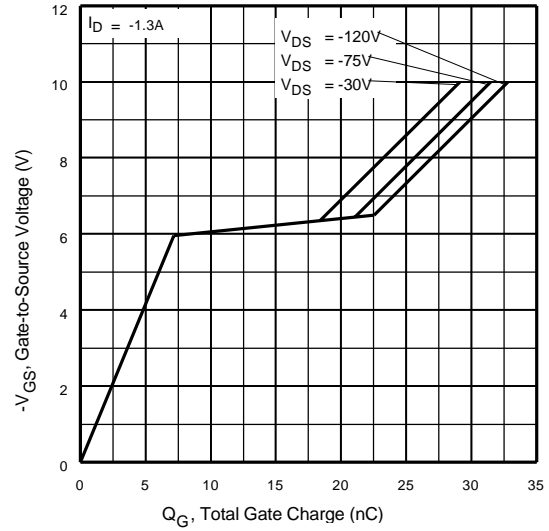

Fig 6. Typical Gate Charge Vs. Gate-to-Source Voltage

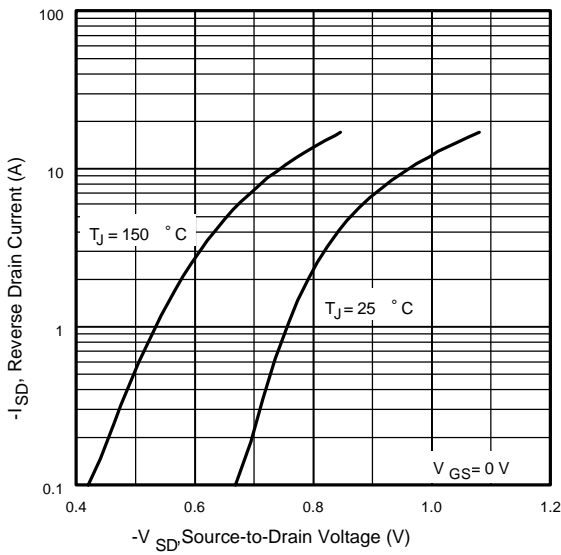

Fig 7. Typical Source-Drain Diode Forward Voltage

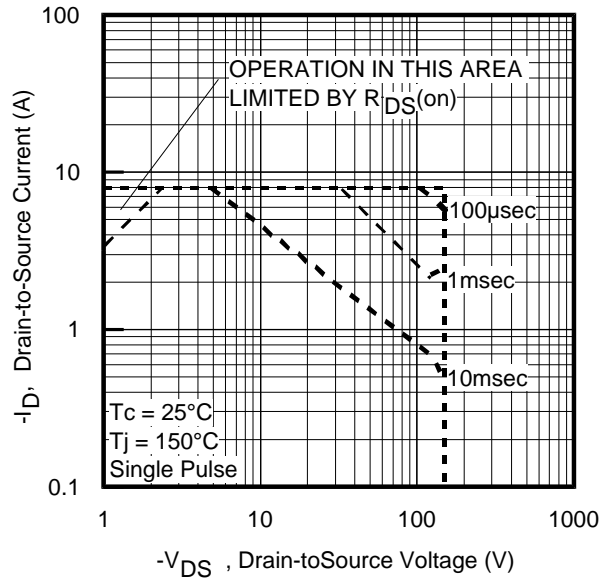

Fig 8. Maximum Safe Operating Area

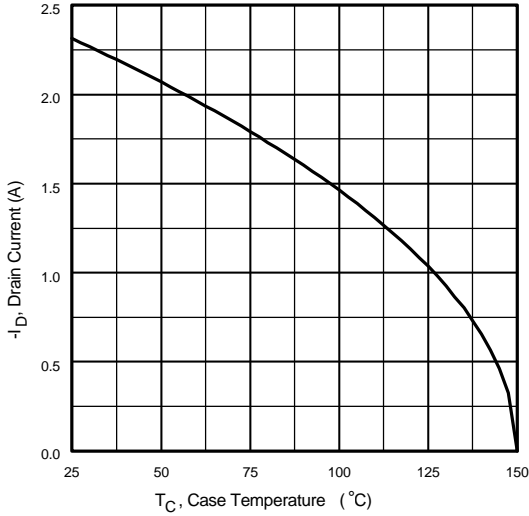

Fig 9. Maximum Drain Current Vs. Ambient Temperature

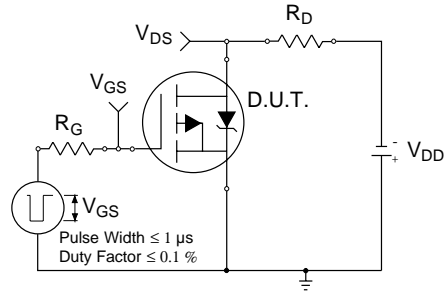

Fig 10a. Switching Time Test Circuit

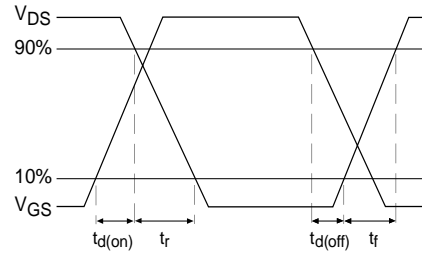

Fig 10b. Switching Time Waveforms

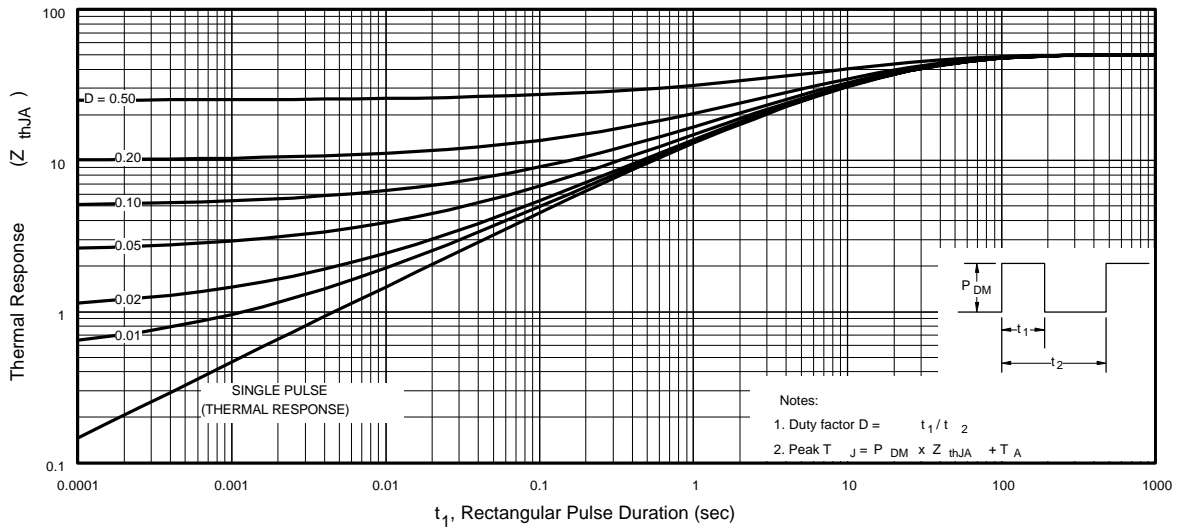

Fig 11. Maximum Effective Transient Thermal Impedance, Junction-to-Ambient

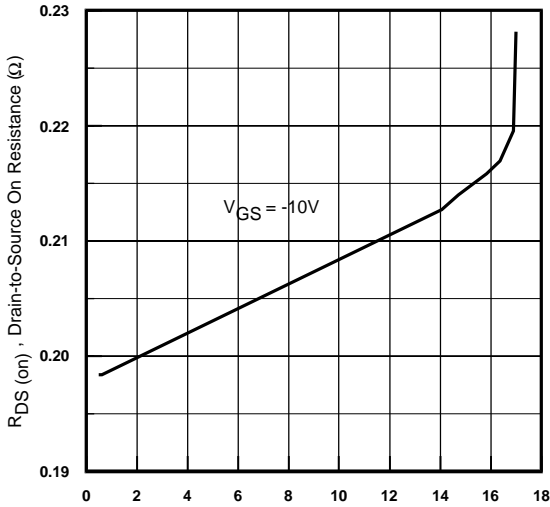

Fig 12. On-Resistance Vs. Drain Current

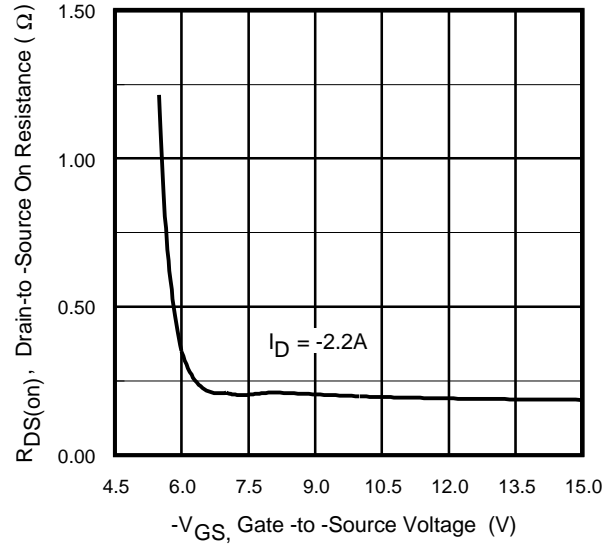

Fig 13. On-Resistance Vs. Gate Voltage

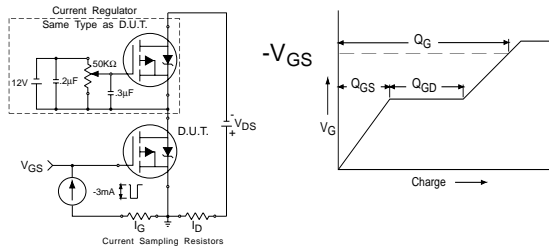

Fig 14a&b. Basic Gate Charge Test Circuit and Waveform

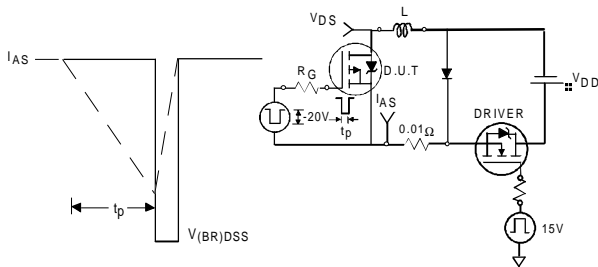

Fig 15a&b. Unclamped Inductive Test circuit and Waveforms

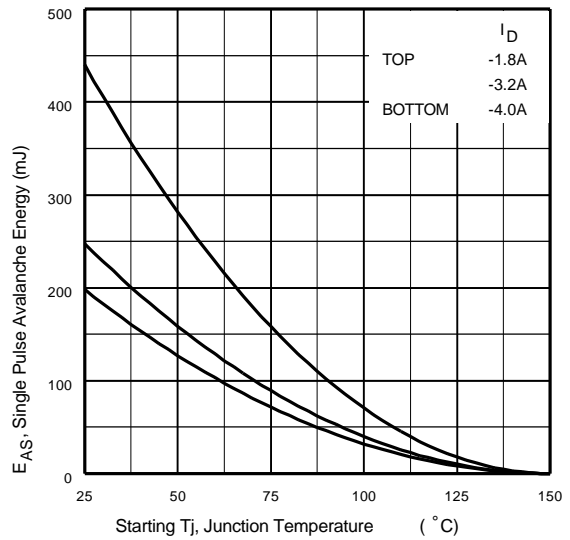
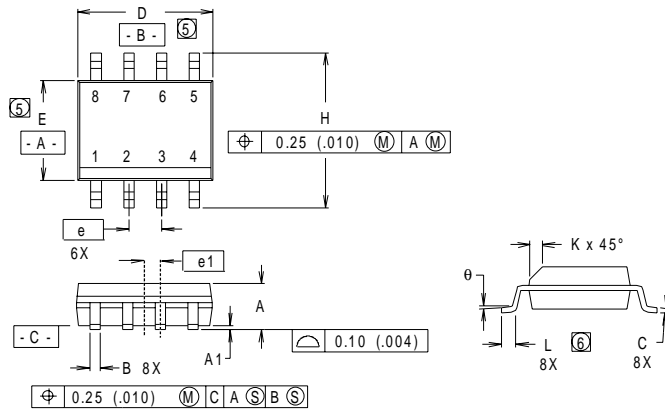

Fig 15c. Maximum Avalanche Energy Vs. Drain Current

SO-8 Package Details



DIM	INCHES		MILLIMETERS	
	MIN	MAX	MIN	MAX
A	.0532	.0688	1.35	1.75
A1	.0040	.0098	0.10	0.25
B	.014	.018	0.36	0.46
C	.0075	.0098	0.19	0.25
D	.189	.196	4.80	4.98
E	.150	.157	3.81	3.99
e	.050 BASIC		1.27 BASIC	
e1	.025 BASIC		0.635 BASIC	
H	.2284	.2440	5.80	6.20
K	.011	.019	0.28	0.48
L	0.16	.050	0.41	1.27
θ	0°	8°	0°	8°

RECOMMENDED FOOTPRINT

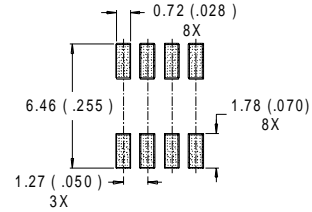

NOTES:

1. DIMENSIONING AND TOLERANCING PER ANSI Y14.5M-1982.
2. CONTROLLING DIMENSION : INCH.
3. DIMENSIONS ARE SHOWN IN MILLIMETERS (INCHES).
4. OUTLINE CONFORMS TO JEDEC OUTLINE MS-012AA.
- ⑤ DIMENSION DOES NOT INCLUDE MOLD PROTRUSIONS
MOLD PROTRUSIONS NOT TO EXCEED 0.25 (.006).
- ⑥ DIMENSIONS IS THE LENGTH OF LEAD FOR SOLDERING TO A SUBSTRATE..

SO-8 Part Marking

EXAMPLE: THIS IS AN IRF7101

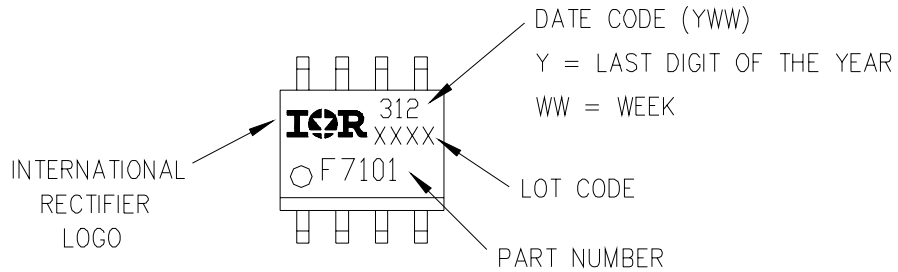

IRF6216

International
IR Rectifier

SO-8 Tape and Reel

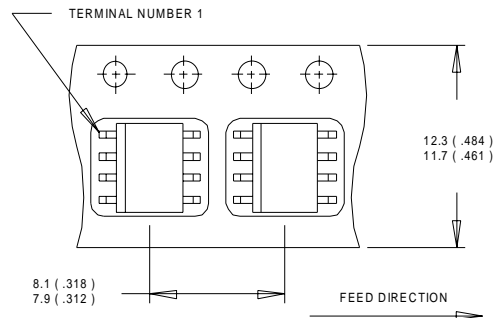

- NOTES:
1. CONTROLLING DIMENSION : MILLIMETER.
 2. ALL DIMENSIONS ARE SHOWN IN MILLIMETERS(INCHES).
 3. OUTLINE CONFORMS TO EIA-481 & EIA-541.

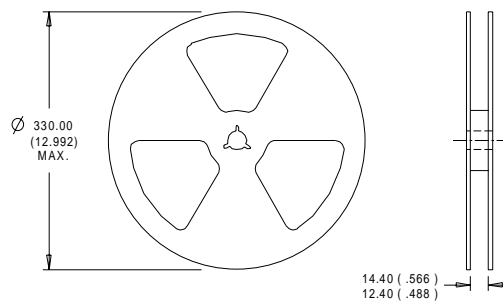

- NOTES:
1. CONTROLLING DIMENSION : MILLIMETER.
 2. OUTLINE CONFORMS TO EIA-481 & EIA-541.

Notes:

- ① Repetitive rating; pulse width limited by max. junction temperature.
- ② Starting $T_J = 25^\circ\text{C}$, $L = 25\text{mH}$
 $R_G = 25\Omega$, $I_{AS} = -4.0\text{A}$.
- ③ Pulse width $\leq 400\mu\text{s}$; duty cycle $\leq 2\%$.
- ④ When mounted on 1 inch square copper board.

Data and specifications subject to change without notice.
This product has been designed and qualified for the Industrial market.
Qualification Standards can be found on IR's Web site.

International
IR Rectifier

IR WORLD HEADQUARTERS: 233 Kansas St., El Segundo, California 90245, USA Tel: (310) 252-7105
TAC Fax: (310) 252-7903

Visit us at www.irf.com for sales contact information.02/02

www.irf.com