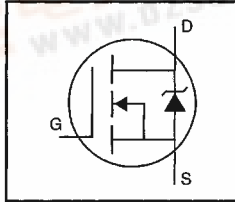


## HEXFET® Power MOSFET

- Dynamic dv/dt Rating
- For Automatic Insertion
- End Stackable
- 175°C Operating Temperature
- Fast Switching
- Ease of Paralleling
- Simple Drive Requirements



$$V_{DSS} = 60V$$

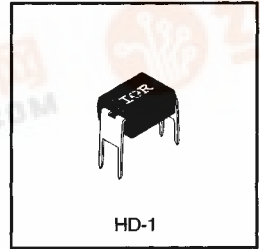
$$R_{DS(on)} = 0.20\Omega$$

$$I_D = 1.7A$$

### Description

Third Generation HEXFETs from International Rectifier provide the designer with the best combination of fast switching, ruggedized device design, low on-resistance and cost-effectiveness.

The 4-pin DIP package is a low cost machine-insertable case style which can be stacked in multiple combinations on standard 0.1 inch pin centers. The dual drain serves as a thermal link to the mounting surface for power dissipation levels up to 1 watt.



DATA SHEETS

### Absolute Maximum Ratings

	Parameter	Max.	Units
$I_D @ T_C = 25^\circ C$	Continuous Drain Current, $V_{GS} @ 10 V$	1.7	A
$I_D @ T_C = 100^\circ C$	Continuous Drain Current, $V_{GS} @ 10 V$	1.2	
$I_{DM}$	Pulsed Drain Current ①	14	
$P_D @ T_C = 25^\circ C$	Power Dissipation	1.3	W
	Linear Derating Factor	0.0083	W/°C
$V_{GS}$	Gate-to-Source Voltage	$\pm 20$	V
$E_{AS}$	Single Pulse Avalanche Energy ②	130	mJ
dv/dt	Peak Diode Recovery dv/dt ③	4.5	V/ns
$T_J$	Operating Junction and Storage Temperature Range	-55 to +175	°C
$T_{STG}$			
	Soldering Temperature, for 10 seconds	300 (1.6mm from case)	

### Thermal Resistance

	Parameter	Min.	Typ.	Max.	Units
$R_{\theta JA}$	Junction-to-Ambient	—	—	120	°C/W



## Electrical Characteristics @ T<sub>J</sub> = 25°C (unless otherwise specified)

	Parameter	Min.	Typ.	Max.	Units	Test Conditions
V <sub>(BR)DSS</sub>	Drain-to-Source Breakdown Voltage	60	—	—	V	V <sub>GS</sub> =0V, I <sub>D</sub> =250μA
ΔV <sub>(BR)DSS</sub> /ΔT <sub>J</sub>	Breakdown Voltage Temp. Coefficient	—	0.063	—	V/°C	Reference to 25°C, I <sub>D</sub> =1mA
R <sub>DS(on)</sub>	Static Drain-to-Source On-Resistance	—	—	0.20	Ω	V <sub>GS</sub> =10V, I <sub>D</sub> =1.0A ④
V <sub>GS(th)</sub>	Gate Threshold Voltage	2.0	—	4.0	V	V <sub>DS</sub> =V <sub>GS</sub> , I <sub>D</sub> =250μA
g <sub>fs</sub>	Forward Transconductance	0.96	—	—	S	V <sub>DS</sub> =25V, I <sub>D</sub> =1.0A ④
I <sub>DSS</sub>	Drain-to-Source Leakage Current	—	—	25	μA	V <sub>DS</sub> =60V, V <sub>GS</sub> =0V
		—	—	250		V <sub>DS</sub> =48V, V <sub>GS</sub> =0V, T <sub>J</sub> =150°C
I <sub>GSS</sub>	Gate-to-Source Forward Leakage	—	—	100	nA	V <sub>GS</sub> =20V
	Gate-to-Source Reverse Leakage	—	—	-100		V <sub>GS</sub> =-20V
Q <sub>g</sub>	Total Gate Charge	—	—	11	nC	I <sub>D</sub> =10A
Q <sub>GS</sub>	Gate-to-Source Charge	—	—	3.1		V <sub>DS</sub> =48V
Q <sub>gd</sub>	Gate-to-Drain ("Miller") Charge	—	—	5.8		V <sub>GS</sub> =10V See Fig. 6 and 13 ④
t <sub>d(on)</sub>	Turn-On Delay Time	—	10	—	ns	V <sub>DD</sub> =30V
t <sub>r</sub>	Rise Time	—	50	—		I <sub>D</sub> =10A
t <sub>d(off)</sub>	Turn-Off Delay Time	—	13	—		R <sub>G</sub> =24Ω
t <sub>f</sub>	Fall Time	—	19	—		R <sub>D</sub> =2.7Ω See Figure 10 ④
L <sub>D</sub>	Internal Drain Inductance	—	4.0	—	nH	Between lead, 6 mm (0.25in.) from package and center of die contact
L <sub>S</sub>	Internal Source Inductance	—	6.0	—		
C <sub>iss</sub>	Input Capacitance	—	310	—	pF	V <sub>GS</sub> =0V
C <sub>oss</sub>	Output Capacitance	—	160	—		V <sub>DS</sub> =25V
C <sub>rss</sub>	Reverse Transfer Capacitance	—	37	—		f=1.0MHz See Figure 5



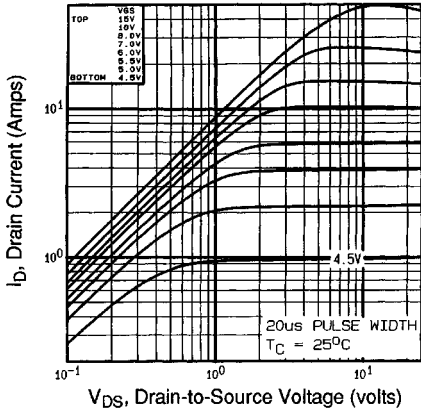
## Source-Drain Ratings and Characteristics

	Parameter	Min.	Typ.	Max.	Units	Test Conditions
I <sub>S</sub>	Continuous Source Current (Body Diode)	—	—	1.7	A	MOSFET symbol showing the integral reverse p-n junction diode.
I <sub>SM</sub>	Pulsed Source Current (Body Diode) ①	—	—	14		
V <sub>SD</sub>	Diode Forward Voltage	—	—	1.6	V	T <sub>J</sub> =25°C, I <sub>S</sub> =1.7A, V <sub>GS</sub> =0V ④
t <sub>rr</sub>	Reverse Recovery Time	—	70	140	ns	T <sub>J</sub> =25°C, I <sub>F</sub> =10A
Q <sub>rr</sub>	Reverse Recovery Charge	—	0.20	0.40	μC	di/dt=100A/μs ④
t <sub>on</sub>	Forward Turn-On Time	Intrinsic turn-on time is negligible (turn-on is dominated by L <sub>S</sub> +L <sub>D</sub> )				

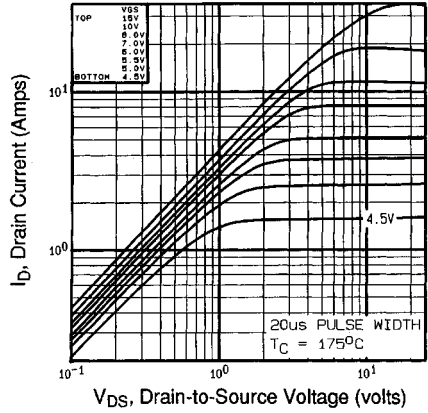


### Notes:

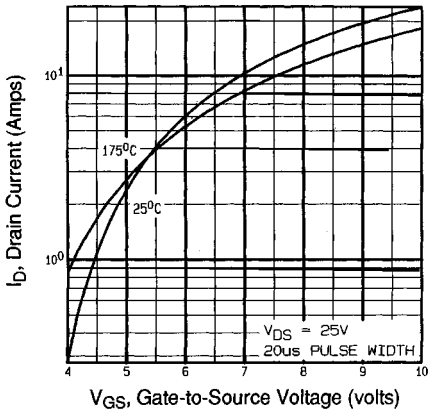
- ① Repetitive rating; pulse width limited by max. junction temperature (See Figure 11)
- ② V<sub>DD</sub>=25V, starting T<sub>J</sub>=25°C, L=52mH, R<sub>G</sub>=25Ω, I<sub>AS</sub>=1.7A (See Figure 12)
- ③ I<sub>SD</sub>≤10A, di/dt≤90A/μs, V<sub>DD</sub>≤V<sub>(BR)DSS</sub>, T<sub>J</sub>≤175°C
- ④ Pulse width ≤ 300 μs; duty cycle ≤2%.



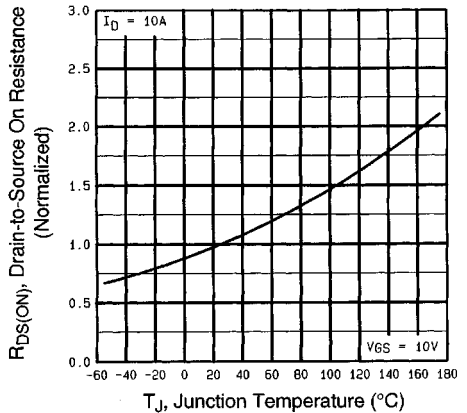
**Fig 1.** Typical Output Characteristics,  
 $T_C=25^\circ\text{C}$



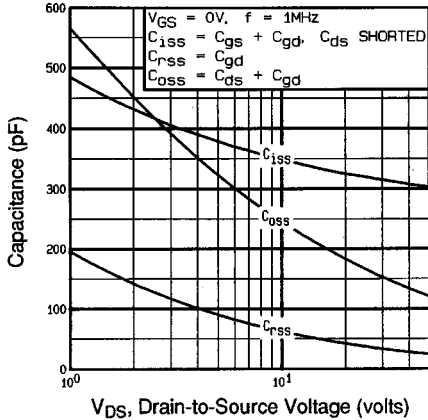
**Fig 2.** Typical Output Characteristics,  
 $T_C=175^\circ\text{C}$



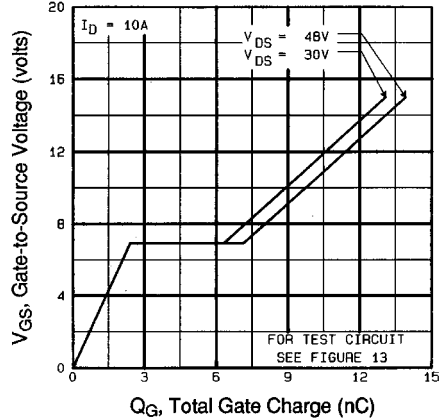
**Fig 3.** Typical Transfer Characteristics



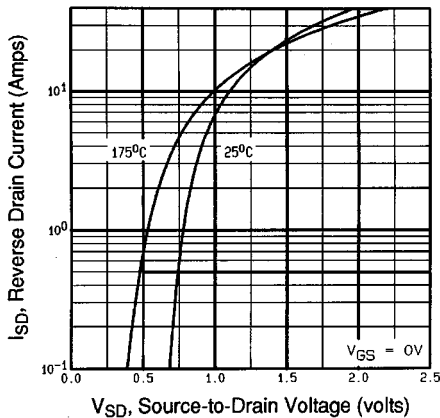
**Fig 4.** Normalized On-Resistance  
Vs. Temperature



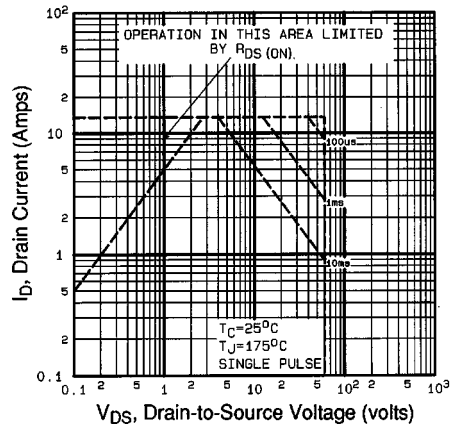
**Fig 5.** Typical Capacitance Vs. Drain-to-Source Voltage



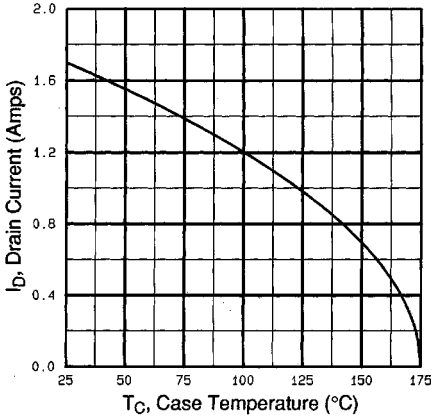
**Fig 6.** Typical Gate Charge Vs. Gate-to-Source Voltage



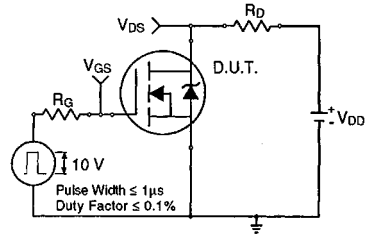
**Fig 7.** Typical Source-Drain Diode Forward Voltage



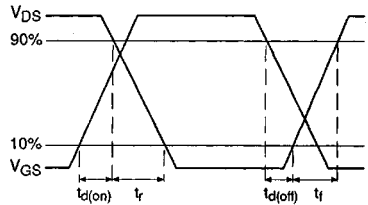
**Fig 8.** Maximum Safe Operating Area



**Fig 9.** Maximum Drain Current Vs. Case Temperature

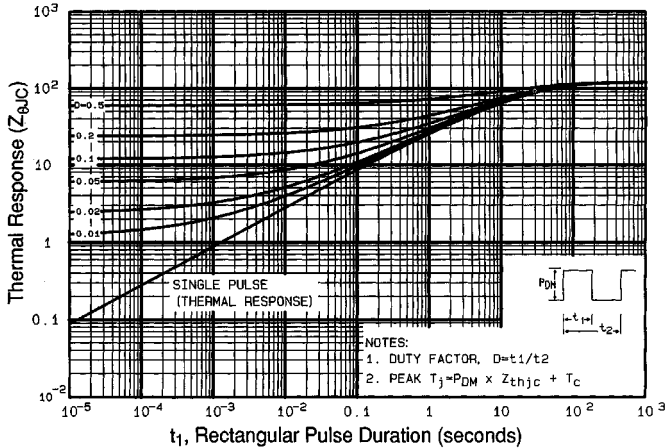


**Fig 10a.** Switching Time Test Circuit

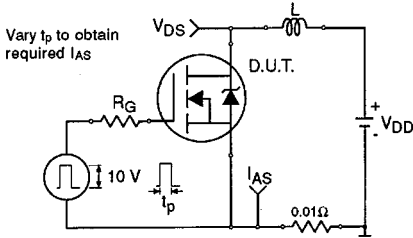


**Fig 10b.** Switching Time Waveforms

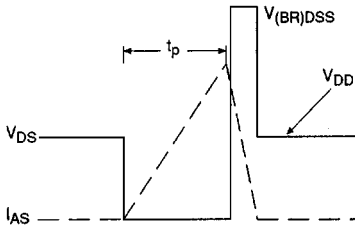
DATA SHEETS



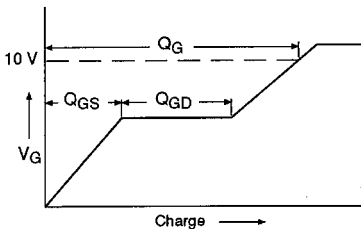
**Fig 11.** Maximum Effective Transient Thermal Impedance, Junction-to-Case



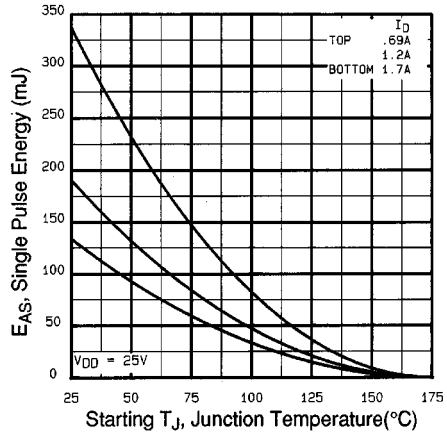
**Fig 12a.** Unclamped Inductive Test Circuit



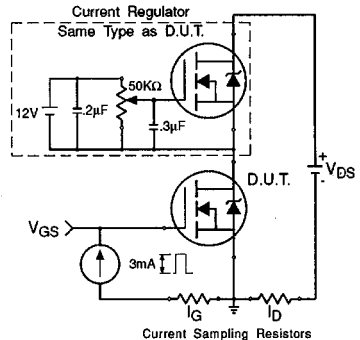
**Fig 12b.** Unclamped Inductive Waveforms



**Fig 13a.** Basic Gate Charge Waveform



**Fig 12c.** Maximum Avalanche Energy Vs. Drain Current



**Fig 13b.** Gate Charge Test Circuit

**Appendix A:** Figure 14, Peak Diode Recovery  $dv/dt$  Test Circuit – See page 1505

**Appendix B:** Package Outline Mechanical Drawing – See page 1507

**Appendix C:** Part Marking Information – See page 1515