

International
IR Rectifier

PD- 94216

SMPS MOSFET

IRFP450N

HEXFET® Power MOSFET

Applications

- Switch Mode Power Supply (SMPS)
- Uninterruptible Power Supply
- High Speed Power Switching

V _{DSS}	R _{ds(on)} max	I _D
500V	0.37Ω	14A

Benefits

- Low Gate Charge Q_g results in Simple Drive Requirement
- Improved Gate, Avalanche and Dynamic dv/dt Ruggedness
- Fully Characterized Capacitance and Avalanche Voltage and Current
- Effective Coss Specified (See AN 1001)

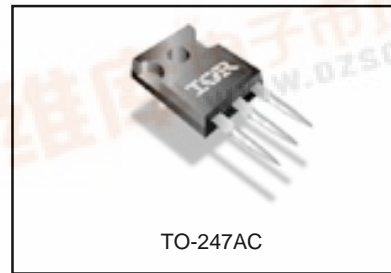

Absolute Maximum Ratings

	Parameter	Max.	Units
I _D @ T _C = 25°C	Continuous Drain Current, V _{GS} @ 10V	14	A
I _D @ T _C = 100°C	Continuous Drain Current, V _{GS} @ 10V	8.8	
I _{DM}	Pulsed Drain Current ①	56	
P _D @ T _C = 25°C	Power Dissipation	200	W
	Linear Derating Factor	1.6	W/°C
V _{GS}	Gate-to-Source Voltage	± 30	V
dv/dt	Peak Diode Recovery dv/dt ③	5.0	V/ns
T _J	Operating Junction and	-55 to + 150	°C
T _{STG}	Storage Temperature Range		
	Soldering Temperature, for 10 seconds	300 (1.6mm from case)	
	Mounting torque, 6-32 or M3 screw	10 lbf•in (1.1N•m)	

Typical SMPS Topologies

- Two transistor Forward
- Half Bridge and Full Bridge
- PFC Boost

Notes ① through ⑤ are on page 8

www.irf.com



IRFP450N

International
IR Rectifier

Static @ $T_J = 25^\circ\text{C}$ (unless otherwise specified)

	Parameter	Min.	Typ.	Max.	Units	Conditions
$V_{(BR)DSS}$	Drain-to-Source Breakdown Voltage	500	—	—	V	$V_{GS} = 0V, I_D = 250\mu A$
$\Delta V_{(BR)DSS}/\Delta T_J$	Breakdown Voltage Temp. Coefficient	—	0.59	—		V/ $^\circ\text{C}$ Reference to 25°C , $I_D = 1\text{mA}$
$R_{DS(on)}$	Static Drain-to-Source On-Resistance	—	—	0.37	Ω	$V_{GS} = 10V, I_D = 8.4A$ ④
$V_{GS(th)}$	Gate Threshold Voltage	3.0	—	5.0	V	$V_{DS} = V_{GS}, I_D = 250\mu A$
I_{DSS}	Drain-to-Source Leakage Current	—	—	25	μA	$V_{DS} = 500V, V_{GS} = 0V$
		—	—	250		$V_{DS} = 400V, V_{GS} = 0V, T_J = 125^\circ\text{C}$
I_{GSS}	Gate-to-Source Forward Leakage	—	—	100	nA	$V_{GS} = 30V$
	Gate-to-Source Reverse Leakage	—	—	-100		$V_{GS} = -30V$

Dynamic @ $T_J = 25^\circ\text{C}$ (unless otherwise specified)

	Parameter	Min.	Typ.	Max.	Units	Conditions
g_{fs}	Forward Transconductance	7.9	—	—	S	$V_{DS} = 50V, I_D = 8.4A$
Q_g	Total Gate Charge	—	—	77	nC	$I_D = 14A$
Q_{gs}	Gate-to-Source Charge	—	—	26		$V_{DS} = 400V$
Q_{gd}	Gate-to-Drain ("Miller") Charge	—	—	34		$V_{GS} = 10V$, See Fig. 6 and 13 ④
$t_{d(on)}$	Turn-On Delay Time	—	20	—	ns	$V_{DD} = 250V$
t_r	Rise Time	—	63	—		$I_D = 14A$
$t_{d(off)}$	Turn-Off Delay Time	—	29	—		$R_G = 6.2\Omega$
t_f	Fall Time	—	25	—		$V_{GS} = 10V$, See Fig. 10 ④
C_{iss}	Input Capacitance	—	2260	—	pF	$V_{GS} = 0V$
C_{oss}	Output Capacitance	—	210	—		$V_{DS} = 25V$
C_{rss}	Reverse Transfer Capacitance	—	14	—		$f = 1.0\text{MHz}$, See Fig. 5
C_{oss}	Output Capacitance	—	2410	—		$V_{GS} = 0V, V_{DS} = 1.0V, f = 1.0\text{MHz}$
C_{oss}	Output Capacitance	—	59	—		$V_{GS} = 0V, V_{DS} = 400V, f = 1.0\text{MHz}$
$C_{oss\ eff.}$	Effective Output Capacitance	—	110	—		$V_{GS} = 0V, V_{DS} = 0V$ to $400V$ ⑤

Avalanche Characteristics

	Parameter	Typ.	Max.	Units
E_{AS}	Single Pulse Avalanche Energy②	—	170	mJ
I_{AR}	Avalanche Current①	—	14	A
E_{AR}	Repetitive Avalanche Energy①	—	20	mJ

Thermal Resistance

	Parameter	Typ.	Max.	Units
$R_{\theta JC}$	Junction-to-Case	—	0.64	$^\circ\text{C}/\text{W}$
$R_{\theta CS}$	Case-to-Sink, Flat, Greased Surface	0.24	—	
$R_{\theta JA}$	Junction-to-Ambient	—	40	

Diode Characteristics

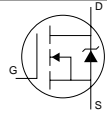
	Parameter	Min.	Typ.	Max.	Units	Conditions
I_S	Continuous Source Current (Body Diode)	—	—	14	A	MOSFET symbol showing the integral reverse p-n junction diode. 
I_{SM}	Pulsed Source Current (Body Diode) ①	—	—	56		
V_{SD}	Diode Forward Voltage	—	—	1.4	V	$T_J = 25^\circ\text{C}, I_S = 14A, V_{GS} = 0V$ ④
t_{rr}	Reverse Recovery Time	—	430	650	ns	$T_J = 25^\circ\text{C}, I_F = 14A$
Q_{rr}	Reverse Recovery Charge	—	3.7	5.6	μC	$di/dt = 100A/\mu s$ ④
t_{on}	Forward Turn-On Time	Intrinsic turn-on time is negligible (turn-on is dominated by L_S+L_D)				

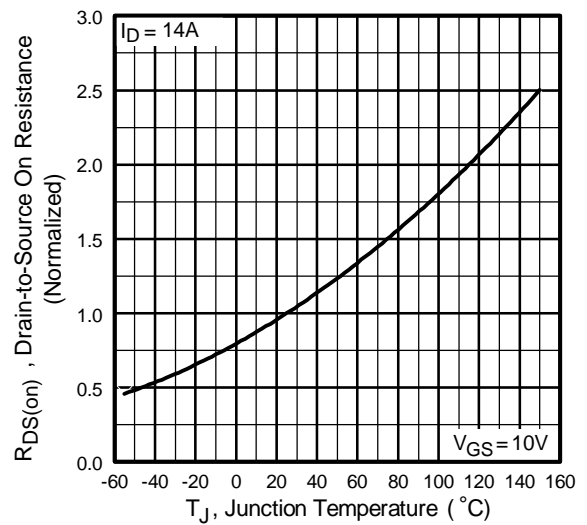
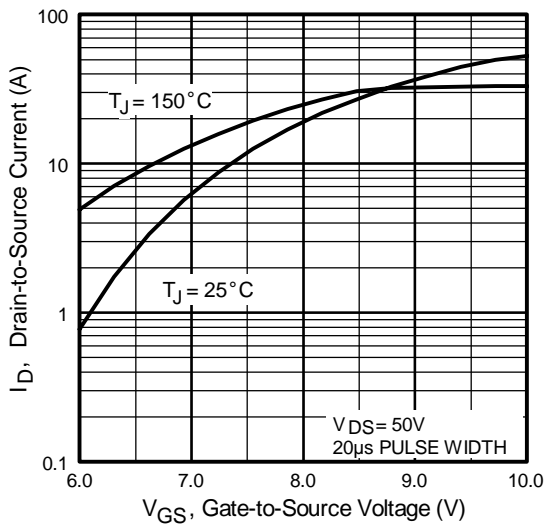
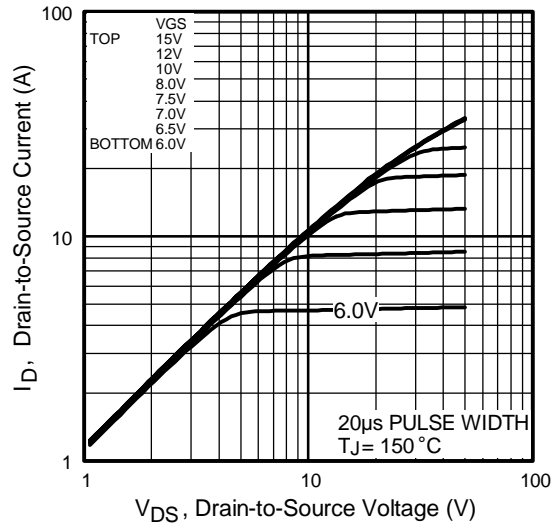
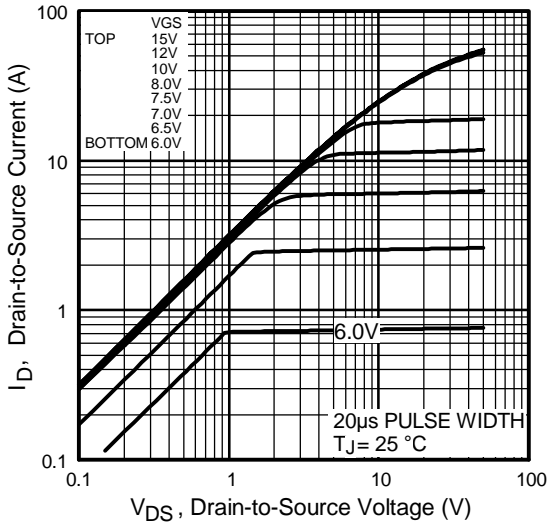

IRFP450N

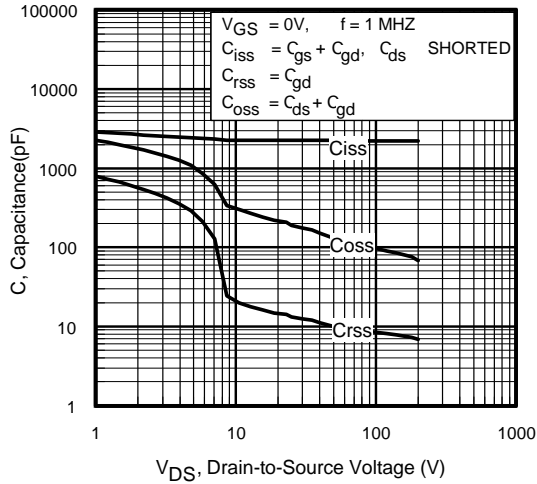

Fig 5. Typical Capacitance Vs. Drain-to-Source Voltage

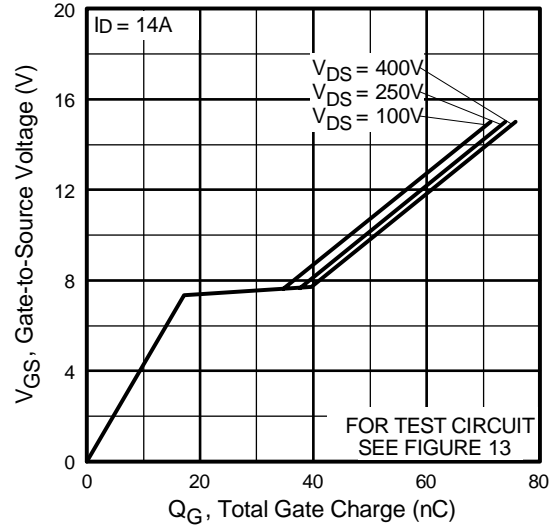

Fig 6. Typical Gate Charge Vs. Gate-to-Source Voltage

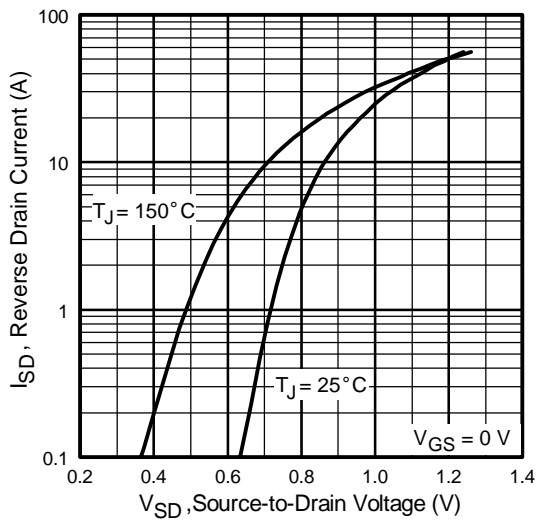

Fig 7. Typical Source-Drain Diode Forward Voltage

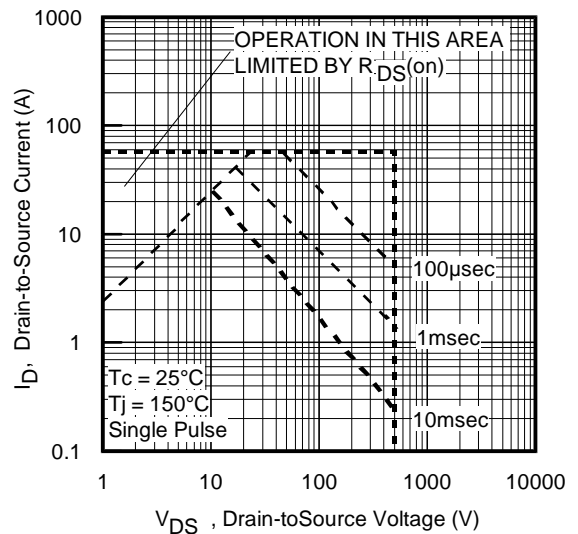

Fig 8. Maximum Safe Operating Area

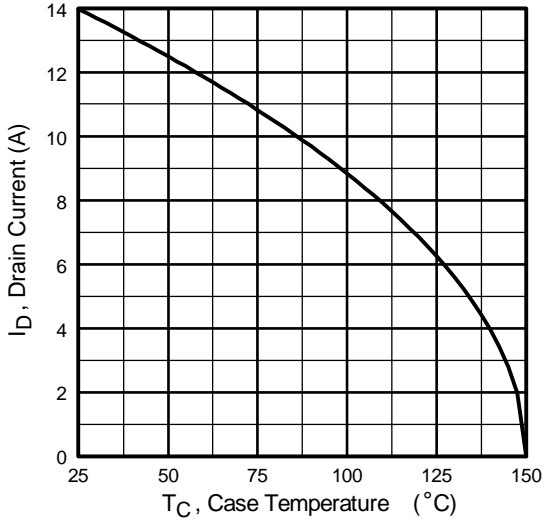

Fig 9. Maximum Drain Current Vs. Case Temperature

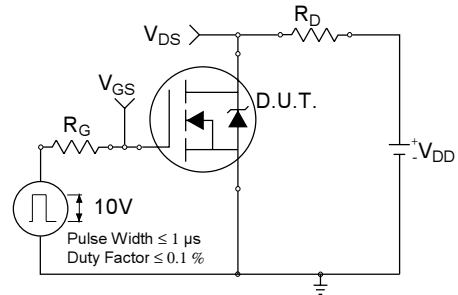

Fig 10a. Switching Time Test Circuit

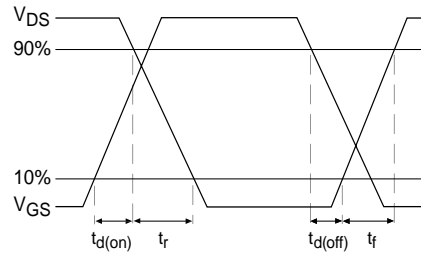

Fig 10b. Switching Time Waveforms

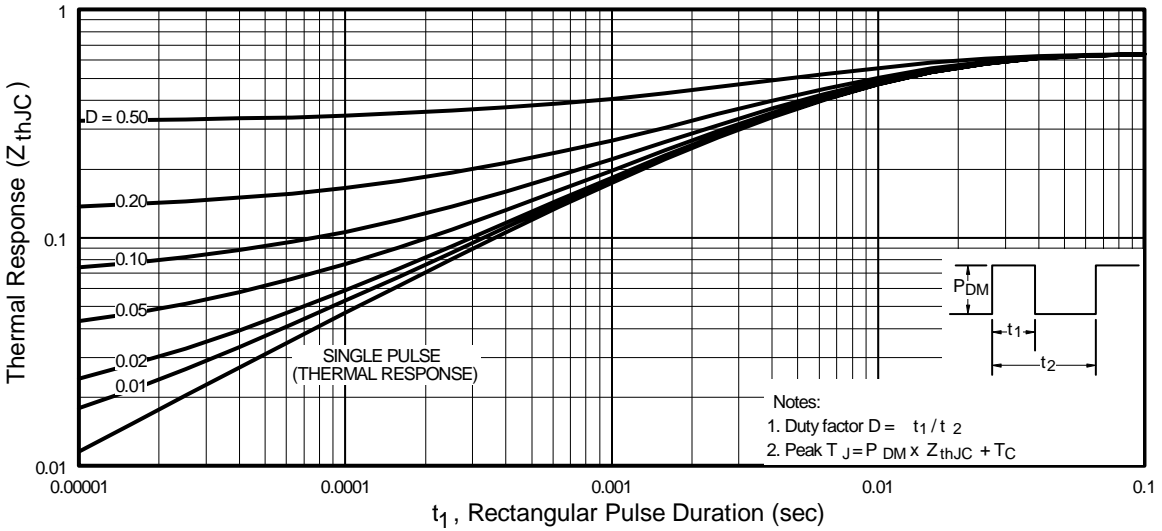

Fig 11. Maximum Effective Transient Thermal Impedance, Junction-to-Case

IRFP450N

International
IR Rectifier

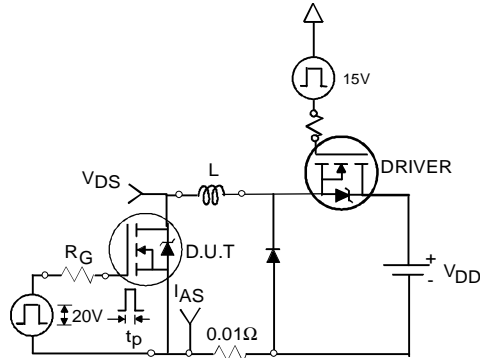

Fig 12a. Unclamped Inductive Test Circuit

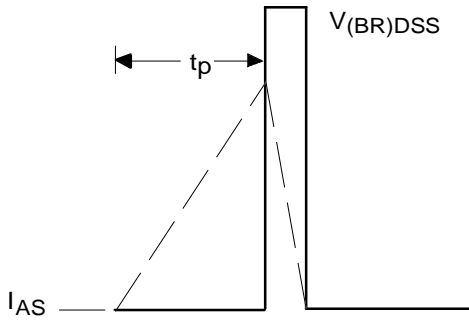

Fig 12b. Unclamped Inductive Waveforms

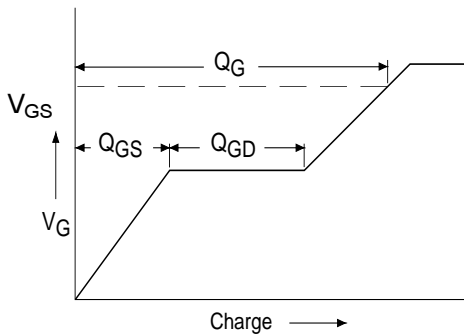

Fig 13a. Basic Gate Charge Waveform

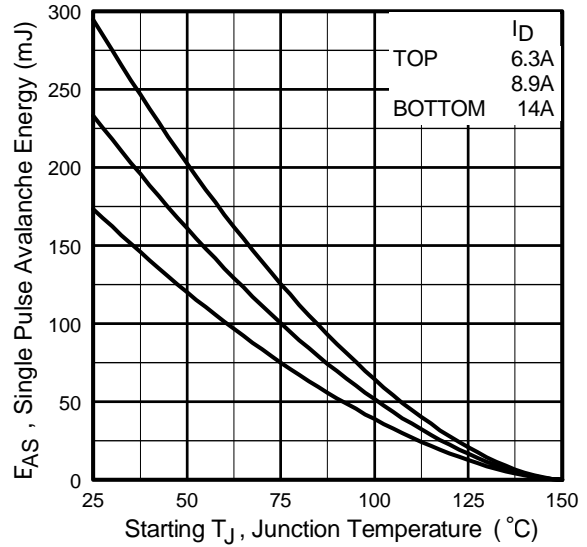

Fig 12c. Maximum Avalanche Energy Vs. Drain Current

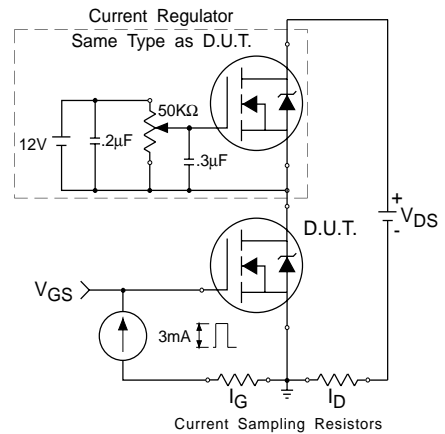
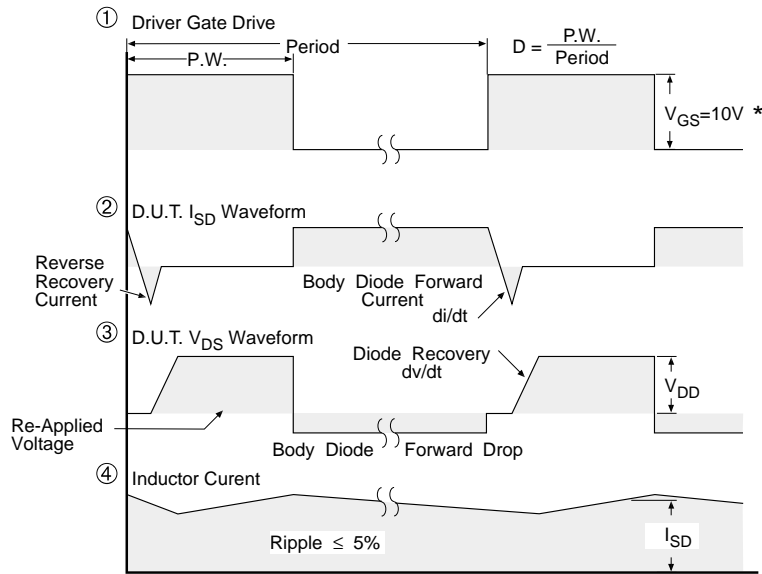
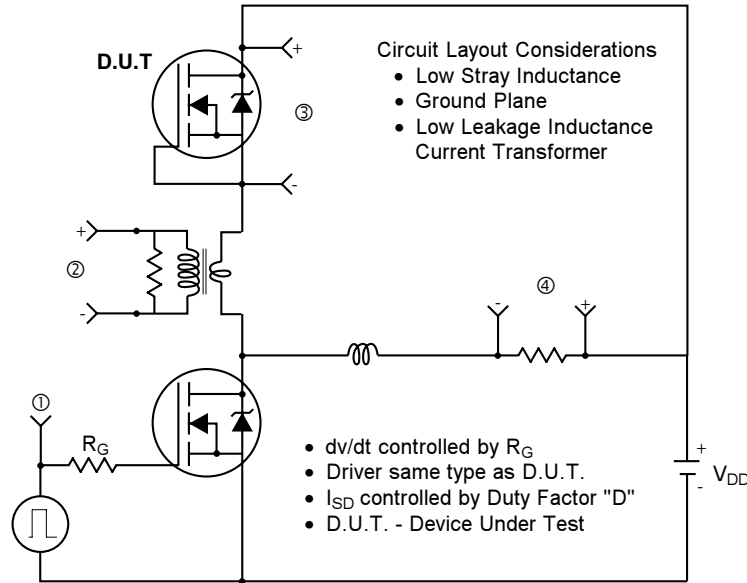

Fig 13b. Gate Charge Test Circuit

Peak Diode Recovery dv/dt Test Circuit



* $V_{GS} = 5V$ for Logic Level Devices

Fig 14. For N-Channel HEXFETS

IRFP450N

International
IR Rectifier

TO-247AC Package Outline

Dimensions are shown in millimeters (inches)

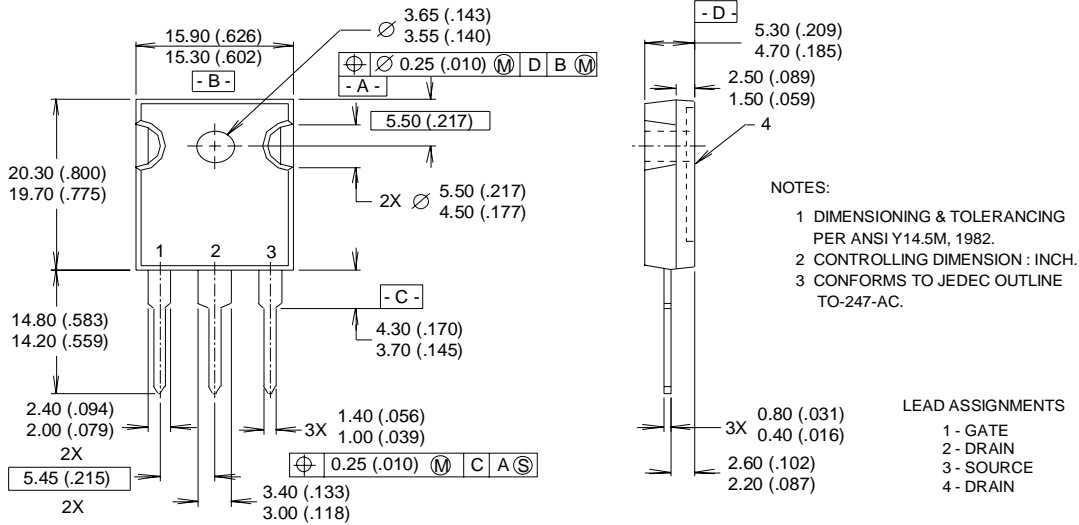

TO-247AC Part Marking Information

EXAMPLE : THIS IS AN IRFPE30
WITH ASSEMBLY
LOT CODE 3A1Q

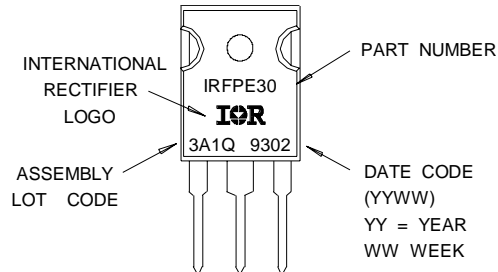

Notes:

- ① Repetitive rating; pulse width limited by max. junction temperature. (See fig. 11)
- ② Starting $T_J = 25^\circ\text{C}$, $L = 1.7\text{mH}$
 $R_G = 25\Omega$, $I_{AS} = 14\text{A}$. (See Figure 12)
- ③ $I_{SD} \leq 14\text{A}$, $di/dt \leq 510\text{A}/\mu\text{s}$, $V_{DD} \leq V_{(BR)DSS}$,
 $T_J \leq 150^\circ\text{C}$
- ④ Pulse width $\leq 400\mu\text{s}$; duty cycle $\leq 2\%$.
- ⑤ C_{OSS} eff. is a fixed capacitance that gives the same charging time as C_{OSS} while V_{DS} is rising from 0 to 80% V_{DSS}

Data and specifications subject to change without notice.

This product has been designed and qualified for the Automotive [Q101] market.

Qualification Standards can be found on IR's Web site.

International
IR Rectifier

IR WORLD HEADQUARTERS: 233 Kansas St., El Segundo, California 90245, USA Tel: (310) 252-7105

TAC Fax: (310) 252-7903

Visit us at www.irf.com for sales contact information. 1/02

www.irf.com