

International IOR Rectifier

PD - 9.1076

IRGPC30M

INSULATED GATE BIPOLAR TRANSISTOR

Short Circuit Rated
Fast IGBT

Features

- Short circuit rated - 10 μ s @ 125 $^{\circ}$ C, $V_{GE} = 15V$
- Switching-loss rating includes all "tail" losses
- Optimized for medium operating frequency (1 to 10kHz) See Fig. 1 for Current vs. Frequency curve

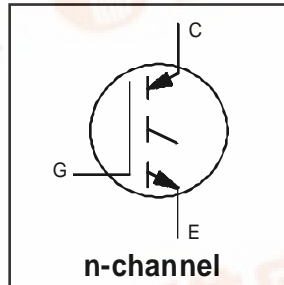

$V_{CES} = 600V$
$V_{CE(sat)} \leq 2.9V$
@ $V_{GE} = 15V, I_C = 16A$

Description

Insulated Gate Bipolar Transistors (IGBTs) from International Rectifier have higher usable current densities than comparable bipolar transistors, while at the same time having simpler gate-drive requirements of the familiar power MOSFET. They provide substantial benefits to a host of high-voltage, high-current applications.

These new short circuit rated devices are especially suited for motor control and other applications requiring short circuit withstand capability.

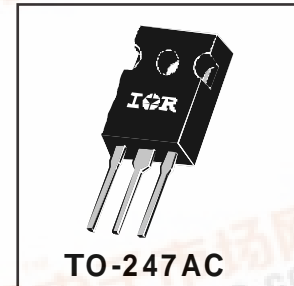

Absolute Maximum Ratings

	Parameter	Max.	Units
V_{CES}	Collector-to-Emitter Voltage	600	V
$I_C @ T_C = 25^{\circ}C$	Continuous Collector Current	26	A
$I_C @ T_C = 100^{\circ}C$	Continuous Collector Current	16	
I_{CM}	Pulsed Collector Current ①	52	
I_{LM}	Clamped Inductive Load Current ②	52	
t_{sc}	Short Circuit Withstand Time	10	μ s
V_{GE}	Gate-to-Emitter Voltage	± 20	V
E_{ARV}	Reverse Voltage Avalanche Energy ③	10	mJ
$P_D @ T_C = 25^{\circ}C$	Maximum Power Dissipation	100	W
$P_D @ T_C = 100^{\circ}C$	Maximum Power Dissipation	42	
T_J	Operating Junction and	-55 to +150	$^{\circ}C$
T_{STG}	Storage Temperature Range		
	Soldering Temperature, for 10 sec.	300 (0.063 in. (1.6mm) from case)	
	Mounting torque, 6-32 or M3 screw.	10 lbf•in (1.1N•m)	

Thermal Resistance

	Parameter	Min.	Typ.	Max.	Units
$R_{\theta JC}$	Junction-to-Case	—	—	1.2	$^{\circ}C/W$
$R_{\theta CS}$	Case-to-Sink, flat, greased surface	—	0.24	—	
$R_{\theta JA}$	Junction-to-Ambient, typical socket mount	—	—	40	
Wt	Weight	—	6 (0.21)	—	g (oz)

Electrical Characteristics @ $T_J = 25^\circ\text{C}$ (unless otherwise specified)

	Parameter	Min.	Typ.	Max.	Units	Conditions
$V_{(BR)CES}$	Collector-to-Emitter Breakdown Voltage	600	—	—	V	$V_{GE} = 0V, I_C = 250\mu A$
$V_{(BR)ECS}$	Emitter-to-Collector Breakdown Voltage ④	20	—	—	V	$V_{GE} = 0V, I_C = 1.0A$
$\Delta V_{(BR)CES}/\Delta T_J$	Temperature Coeff. of Breakdown Voltage	—	0.65	—	V/ $^\circ\text{C}$	$V_{GE} = 0V, I_C = 1.0mA$
$V_{CE(on)}$	Collector-to-Emitter Saturation Voltage	—	1.9	2.9	V	$I_C = 16A$ $V_{GE} = 15V$
		—	2.7	—		$I_C = 26A$ See Fig. 2, 5
		—	2.2	—		$I_C = 16A, T_J = 150^\circ\text{C}$
$V_{GE(th)}$	Gate Threshold Voltage	3.0	—	5.5		$V_{CE} = V_{GE}, I_C = 250\mu A$
$\Delta V_{GE(th)}/\Delta T_J$	Temperature Coeff. of Threshold Voltage	—	-12	—	mV/ $^\circ\text{C}$	$V_{CE} = V_{GE}, I_C = 250\mu A$
g_{fe}	Forward Transconductance ⑤	3.3	6.5	—	S	$V_{CE} = 100V, I_C = 16A$
I_{CES}	Zero Gate Voltage Collector Current	—	—	250	μA	$V_{GE} = 0V, V_{CE} = 600V$
		—	—	1000		$V_{GE} = 0V, V_{CE} = 600V, T_J = 150^\circ\text{C}$
I_{GES}	Gate-to-Emitter Leakage Current	—	—	± 100	nA	$V_{GE} = \pm 20V$

Switching Characteristics @ $T_J = 25^\circ\text{C}$ (unless otherwise specified)

	Parameter	Min.	Typ.	Max.	Units	Conditions
Q_g	Total Gate Charge (turn-on)	—	35	53	nC	$I_C = 16A$
Q_{ge}	Gate - Emitter Charge (turn-on)	—	7.4	11		$V_{CC} = 400V$ See Fig. 8
Q_{gc}	Gate - Collector Charge (turn-on)	—	14	21		$V_{GE} = 15V$
$t_{d(on)}$	Turn-On Delay Time	—	31	—	ns	$T_J = 25^\circ\text{C}$
t_r	Rise Time	—	31	—		$I_C = 16A, V_{CC} = 480V$
$t_{d(off)}$	Turn-Off Delay Time	—	280	420		$V_{GE} = 15V, R_G = 23\Omega$
t_f	Fall Time	—	310	470		Energy losses include "tail"
E_{on}	Turn-On Switching Loss	—	0.4	—		mJ
E_{off}	Turn-Off Switching Loss	—	1.9	—		
E_{ts}	Total Switching Loss	—	2.3	3.5		
t_{sc}	Short Circuit Withstand Time	10	—	—	μs	$V_{CC} = 360V, T_J = 125^\circ\text{C}$ $V_{GE} = 15V, R_G = 23\Omega, V_{CPK} < 500V$
$t_{d(on)}$	Turn-On Delay Time	—	31	—	ns	$T_J = 150^\circ\text{C},$ $I_C = 14A, V_{CC} = 480V$ $V_{GE} = 15V, R_G = 23\Omega$ Energy losses include "tail"
t_r	Rise Time	—	30	—		
$t_{d(off)}$	Turn-Off Delay Time	—	530	—		
t_f	Fall Time	—	660	—		
E_{ts}	Total Switching Loss	—	4.4	—		
L_E	Internal Emitter Inductance	—	13	—	nH	Measured 5mm from package
C_{ies}	Input Capacitance	—	750	—	pF	$V_{GE} = 0V$ $V_{CC} = 30V$ See Fig. 7 $f = 1.0MHz$
C_{oes}	Output Capacitance	—	110	—		
C_{res}	Reverse Transfer Capacitance	—	9.3	—		

Notes:

- ① Repetitive rating; $V_{GE}=20V$, pulse width limited by max. junction temperature. (See fig. 13b)
- ② $V_{CC}=80\%(V_{CES}), V_{GE}=20V, L=10\mu H, R_G=23\Omega,$ (See fig. 13a)
- ③ Repetitive rating; pulse width limited by maximum junction temperature.
- ④ Pulse width $\leq 80\mu s$; duty factor $\leq 0.1\%$.
- ⑤ Pulse width 5.0 μs , single shot.

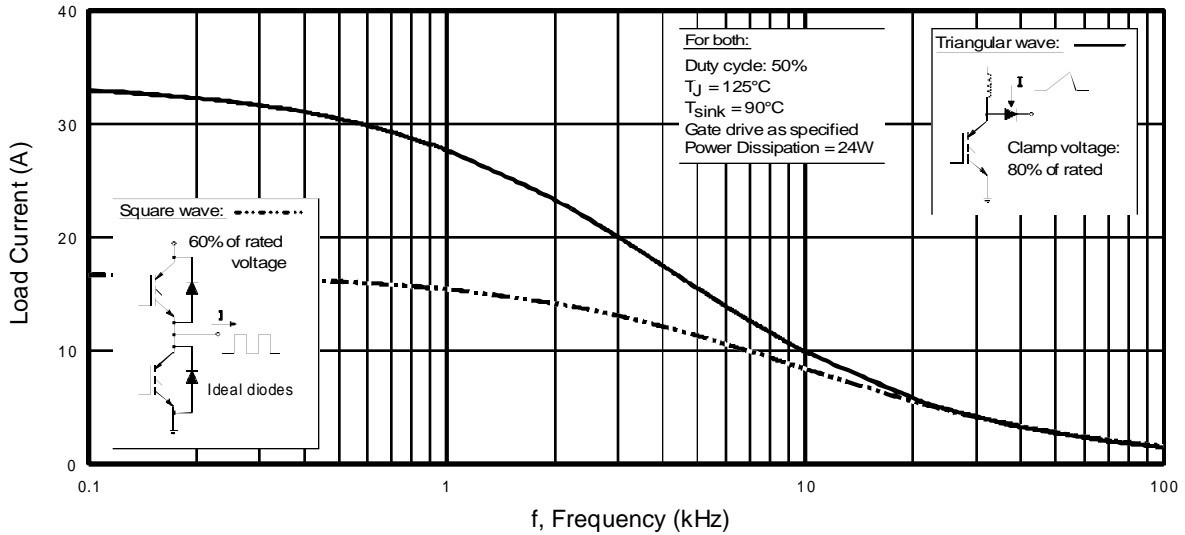

Fig. 1 - Typical Load Current vs. Frequency
 (For square wave, $I = I_{RMS}$ of fundamental; for triangular wave, $I = I_{PK}$)

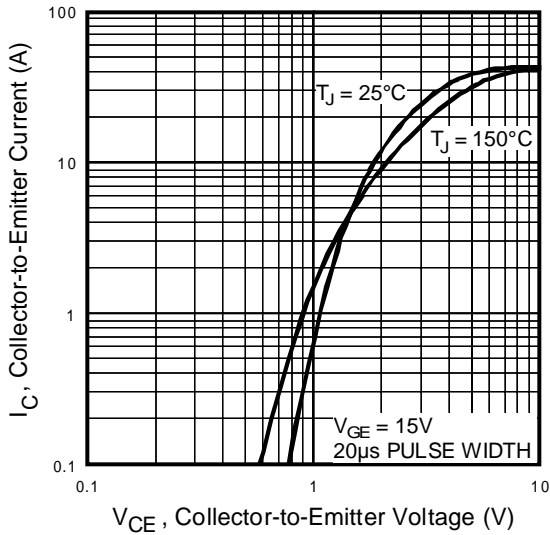

Fig. 2 - Typical Output Characteristics

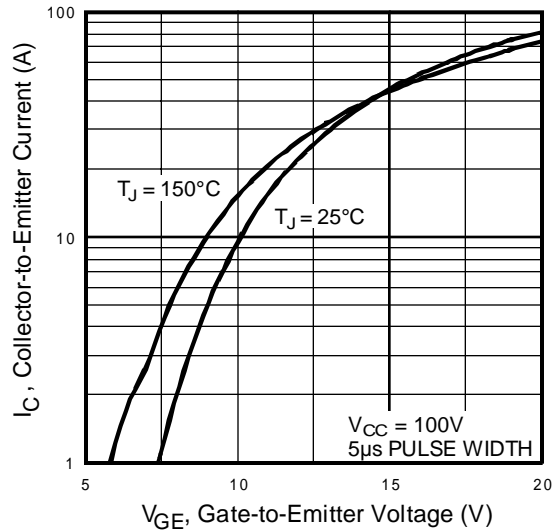

Fig. 3 - Typical Transfer Characteristics

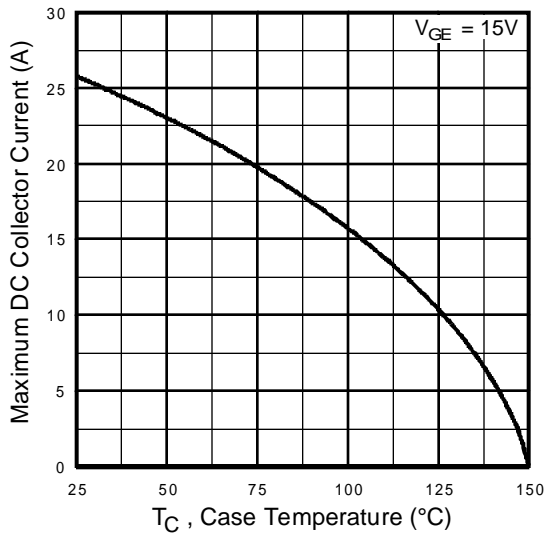

Fig. 4 - Maximum Collector Current vs. Case Temperature

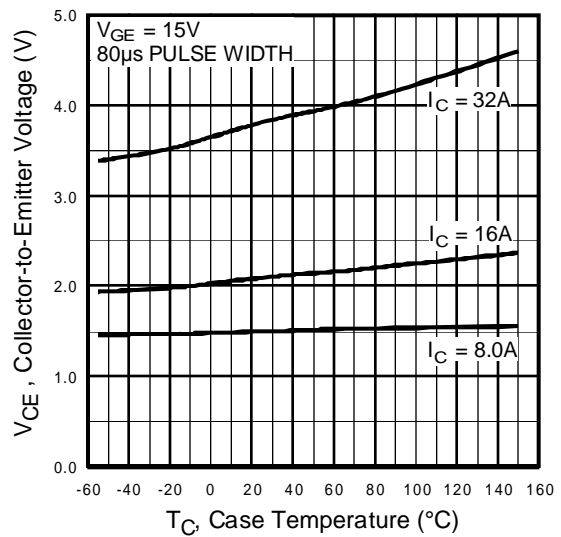

Fig. 5 - Collector-to-Emitter Voltage vs. Case Temperature

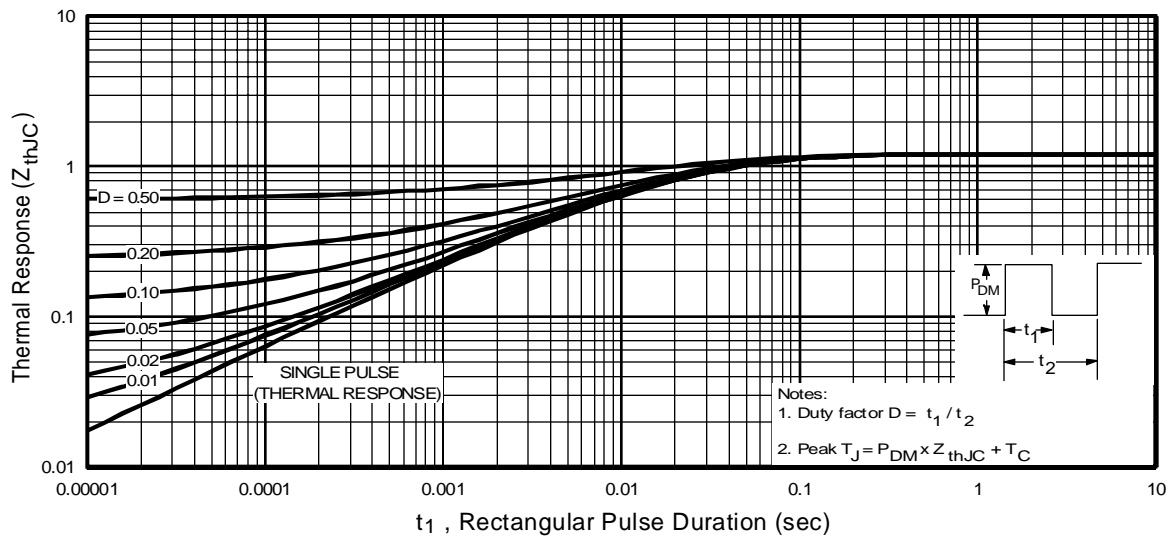

Fig. 6 - Maximum Effective Transient Thermal Impedance, Junction-to-Case

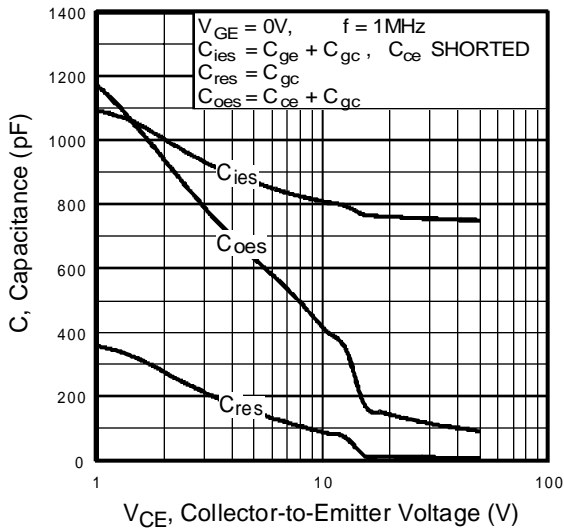

Fig. 7 - Typical Capacitance vs. Collector-to-Emitter Voltage

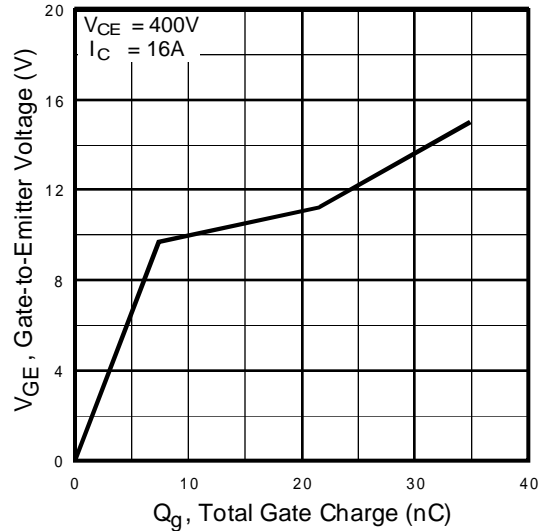

Fig. 8 - Typical Gate Charge vs. Gate-to-Emitter Voltage

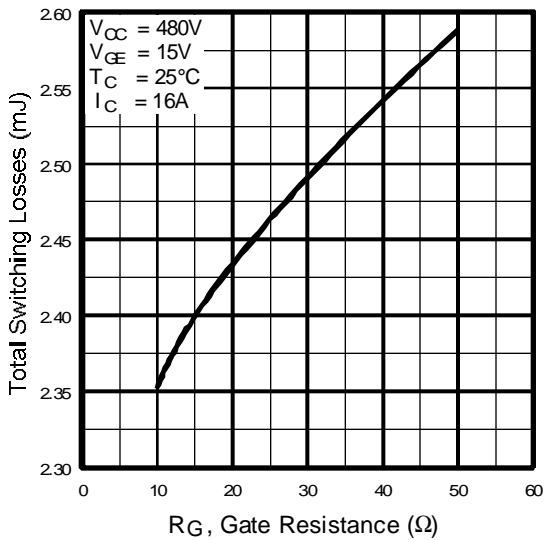

Fig. 9 - Typical Switching Losses vs. Gate Resistance

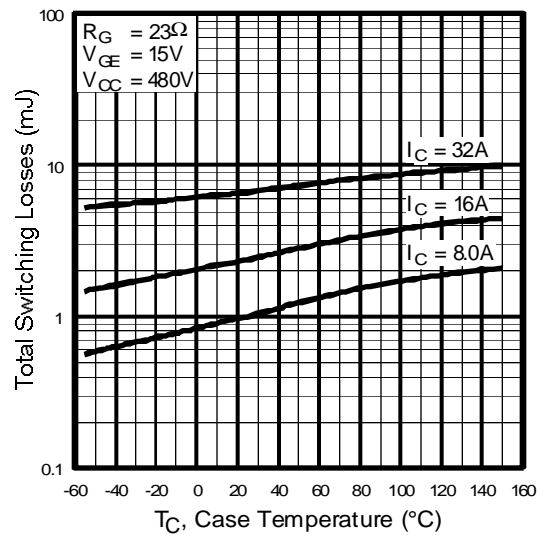

Fig. 10 - Typical Switching Losses vs. Case Temperature

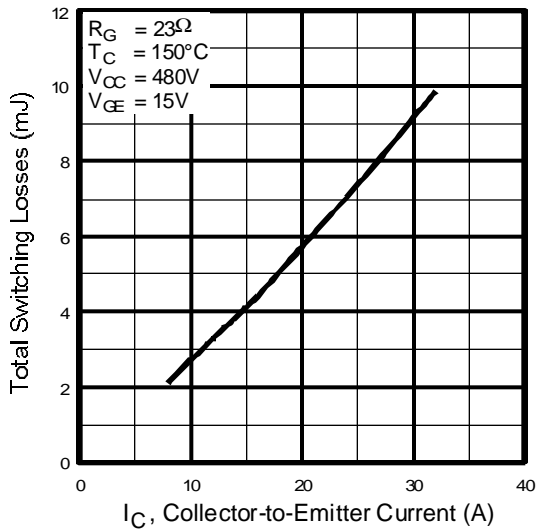

Fig. 11 - Typical Switching Losses vs. Collector-to-Emitter Current

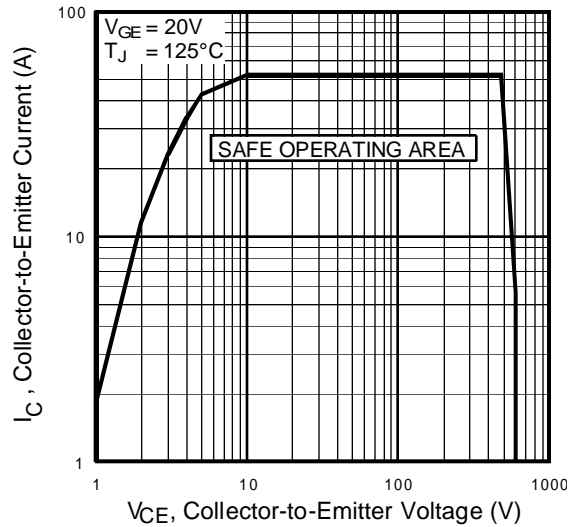
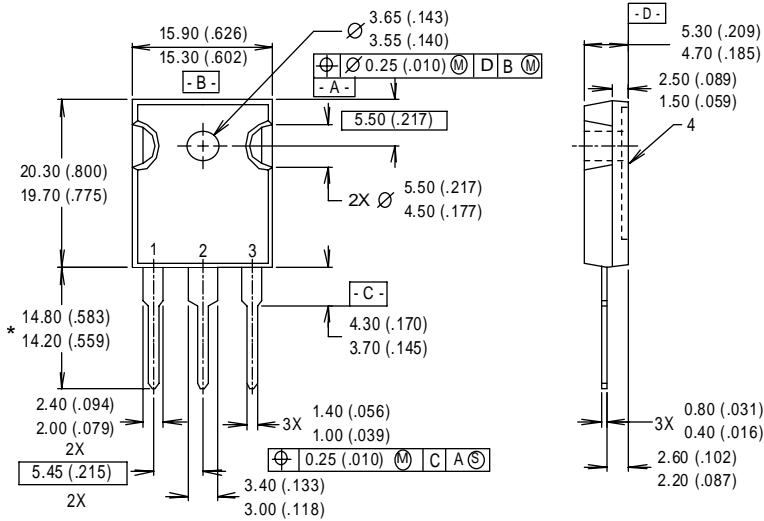

Fig. 12 - Turn-Off SOA



NOTES:

- 1 DIMENSIONS & TOLERANCING PER ANSI Y14.5M, 1982.
- 2 CONTROLLING DIMENSION : INCH.
- 3 DIMENSIONS ARE SHOWN MILLIMETERS (INCHES).
- 4 CONFORMS TO JEDEC OUTLINE TO-247AC.

LEAD ASSIGNMENTS

- 1 - GATE
- 2 - COLLECTOR
- 3 - EMITTER
- 4 - COLLECTOR

* LONGER LEADED (20mm) VERSION AVAILABLE (TO-247AD) TO ORDER ADD "E" SUFFIX TO PART NUMBER

CONFORMS TO JEDEC OUTLINE TO-247AC (TO-3P)

Dimensions in Millimeters and (Inches)

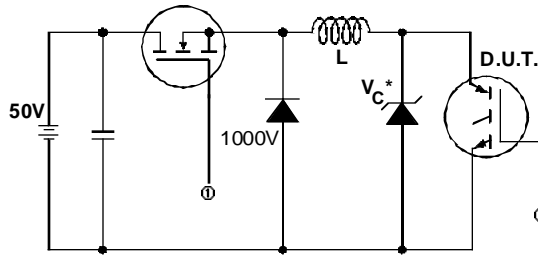

* Driver same type as D.U.T.; $V_c = 80\%$ of $V_{ce(max)}$
 * Note: Due to the 50V power supply, pulse width and inductor will increase to obtain rated I_d .

Fig. 13a - Clamped Inductive Load Test Circuit

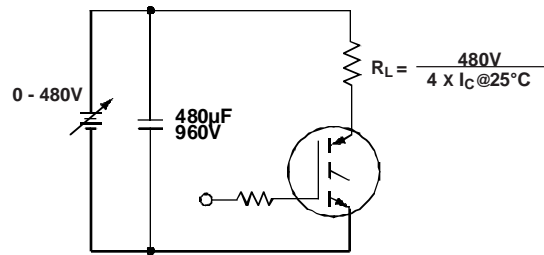

Fig. 13b - Pulsed Collector Current Test Circuit

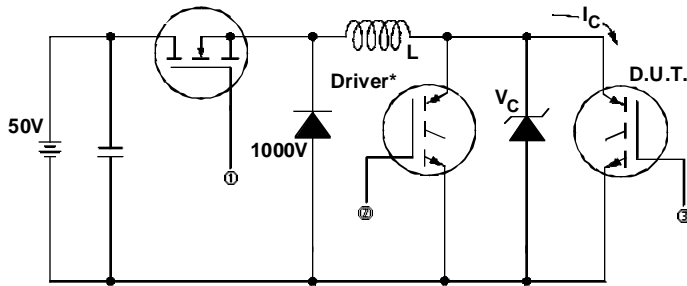

Fig. 14a - Switching Loss Test Circuit

* Driver same type as D.U.T., $V_c = 480V$

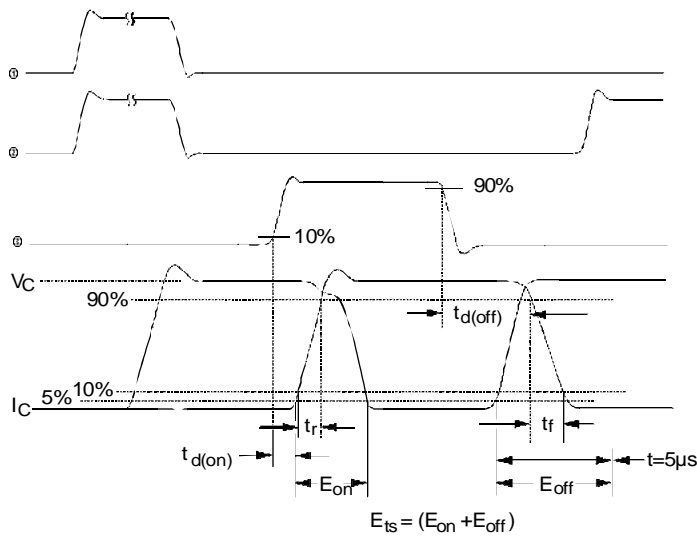

Fig. 14b - Switching Loss Waveforms