

International IR Rectifier

PD - 93786A

RADIATION HARDENED POWER MOSFET THRU-HOLE (TO-254AA)

IRHM57Z60
30V, N-CHANNEL
R5 TECHNOLOGY

Product Summary

Part Number	Radiation Level	R _{DS(on)}	I _D
IRHM57Z60	100K Rads (Si)	0.0095Ω	35A*
IRHM53Z60	300K Rads (Si)	0.0095Ω	35A*
IRHM54Z60	600K Rads (Si)	0.0095Ω	35A*
IRHM58Z60	1000K Rads (Si)	0.010Ω	35A*



International Rectifier's R5™ technology provides high performance power MOSFETs for space applications. These devices have been characterized for Single Event Effects (SEE) with useful performance up to an LET of 80 (MeV/(mg/cm²)). The combination of low R_{DS(on)} and low gate charge reduces the power losses in switching applications such as DC to DC converters and motor control. These devices retain all of the well established advantages of MOSFETs such as voltage control, fast switching, ease of paralleling and temperature stability of electrical parameters.

Features:

- Single Event Effect (SEE) Hardened
- Neutron Tolerant
- Identical Pre- and Post-Electrical Test Conditions
- Repetitive Avalanche Ratings
- Dynamic dv/dt Ratings
- Simple Drive Requirements
- Ease of Paralleling
- Hermetically Sealed
- Electrically Isolated
- Ceramic Eyelets
- Light Weight

Absolute Maximum Ratings

Pre-Irradiation

	Parameter		Units
I _D @ V _{GS} = 12V, T _C = 25°C	Continuous Drain Current	35*	A
I _D @ V _{GS} = 12V, T _C = 100°C	Continuous Drain Current	35*	
I _{DM}	Pulsed Drain Current ①	140	
P _D @ T _C = 25°C	Max. Power Dissipation	250	W
	Linear Derating Factor	2.0	W/°C
V _{GS}	Gate-to-Source Voltage	±20	V
EAS	Single Pulse Avalanche Energy ②	500	mJ
I _{AR}	Avalanche Current ①	35	A
EAR	Repetitive Avalanche Energy ①	25	mJ
dv/dt	Peak Diode Recovery dv/dt ③	1.1	V/ns
T _J	Operating Junction	-55 to 150	°C
T _{STG}	Storage Temperature Range		
	Lead Temperature	300 (0.063 in./1.6 mm from case for 10s)	
	Weight	9.3 (Typical)	g

* Current is limited by internal wire diameter
For footnotes refer to the last page



Electrical Characteristics @ T_j = 25°C (Unless Otherwise Specified)

	Parameter	Min	Typ	Max	Units	Test Conditions
B _V DSS	Drain-to-Source Breakdown Voltage	30	—	—	V	V _{GS} = 0V, I _D = 1.0mA
ΔB _V DSS/ΔT _J	Temperature Coefficient of Breakdown Voltage	—	0.028	—	V/°C	Reference to 25°C, I _D = 1.0mA
R _{DS(on)}	Static Drain-to-Source On-State Resistance	—	—	0.0095	Ω	V _{GS} = 12V, I _D = 35A ④
V _{GS(th)}	Gate Threshold Voltage	2.0	—	4.0	V	V _{DS} = V _{GS} , I _D = 1.0mA
g _{fs}	Forward Transconductance	45	—	—	S (Ω)	V _{DS} > 15V, I _{DS} = 35A ④
I _{DSS}	Zero Gate Voltage Drain Current	—	—	10	μA	V _{DS} = 24V, V _{GS} = 0V
		—	—	25		V _{DS} = 24V, V _{GS} = 0V, T _J = 125°C
I _{GSS}	Gate-to-Source Leakage Forward	—	—	100	nA	V _{GS} = 20V
I _{GSS}	Gate-to-Source Leakage Reverse	—	—	-100		V _{GS} = -20V
Q _g	Total Gate Charge	—	—	200	nC	V _{GS} = 12V, I _D = 35A
Q _{gs}	Gate-to-Source Charge	—	—	55		V _{DS} = 15V
Q _{gd}	Gate-to-Drain ('Miller') Charge	—	—	40		
t _{d(on)}	Turn-On Delay Time	—	—	35	ns	V _{DD} = 15V, I _D = 35A R _G = 2.35Ω
t _r	Rise Time	—	—	125		
t _{d(off)}	Turn-Off Delay Time	—	—	80		
t _f	Fall Time	—	—	50		
L _S + L _D	Total Inductance	—	6.8	—	nH	Measured from Drain lead (6mm /0.25in. from package) to Source lead (6mm /0.25in. from package) with Source wires internally bonded from Source Pin to Drain Pad
C _{iss}	Input Capacitance	—	9720	—	pF	V _{GS} = 0V, V _{DS} = 25V f = 1.0MHz
C _{oss}	Output Capacitance	—	4230	—		
C _{rss}	Reverse Transfer Capacitance	—	56	—		

Source-Drain Diode Ratings and Characteristics

	Parameter	Min	Typ	Max	Units	Test Conditions
I _S	Continuous Source Current (Body Diode)	—	—	35*	A	
I _{SM}	Pulse Source Current (Body Diode) ①	—	—	140		
V _{SD}	Diode Forward Voltage	—	—	1.2	V	T _j = 25°C, I _S = 35A, V _{GS} = 0V ④
t _{rr}	Reverse Recovery Time	—	—	153	ns	T _j = 25°C, I _F = 35A, di/dt ≥ 100A/μs
Q _{RR}	Reverse Recovery Charge	—	—	324	nC	V _{DD} ≤ 25V ④
t _{on}	Forward Turn-On Time	Intrinsic turn-on time is negligible. Turn-on speed is substantially controlled by L _S + L _D .				

* Current is limited by internal wire diameter

Thermal Resistance

	Parameter	Min	Typ	Max	Units	Test Conditions
R _{thJC}	Junction-to-Case	—	—	0.50	°C/W	Typical socket mount
R _{thCS}	Case-to-Sink	—	0.21	—		
R _{thJA}	Junction-to-Ambient	—	—	48		

Note: Corresponding Spice and Saber models are available on the G&S Website.

For footnotes refer to the last page

Radiation Characteristics

IRHM57Z60

International Rectifier Radiation Hardened MOSFETs are tested to verify their radiation hardness capability. The hardness assurance program at International Rectifier is comprised of two radiation environments. Every manufacturing lot is tested for total ionizing dose (per notes 5 and 6) using the TO-3 package. Both pre- and post-irradiation performance are tested and specified using the same drive circuitry and test conditions in order to provide a direct comparison.

Table 1. Electrical Characteristics @ Tj = 25°C, Post Total Dose Irradiation ⑤⑥

	Parameter	Up to 600K Rads(Si) ¹		1000K Rads (Si) ²		Units	Test Conditions
		Min	Max	Min	Max		
BV _{DSS}	Drain-to-Source Breakdown Voltage	30	—	30	—	V	V _{GS} = 0V, I _D = 1.0mA
V _{GS(th)}	Gate Threshold Voltage ④	2.0	4.0	1.5	4.0		V _{GS} = V _{DS} , I _D = 1.0mA
I _{GSS}	Gate-to-Source Leakage Forward	—	100	—	100	nA	V _{GS} = 20V
I _{GSS}	Gate-to-Source Leakage Reverse	—	-100	—	-100		V _{GS} = -20V
I _{DSS}	Zero Gate Voltage Drain Current	—	10	—	10	μA	V _{DS} = 24V, V _{GS} = 0V
R _{DS(on)}	Static Drain-to-Source ④ On-State Resistance (TO-3)	—	0.004	—	0.005	Ω	V _{GS} = 12V, I _D = 35A
R _{DS(on)}	Static Drain-to-Source ④ On-State Resistance (TO-254)	—	0.0095	—	0.01	Ω	V _{GS} = 12V, I _D = 35A
V _{SD}	Diode Forward Voltage ④	—	1.2	—	1.2	V	V _{GS} = 0V, I _S = 35A

1. Part numbers IRHM57Z60, IRHM53Z60 and IRHM54Z60

2. Part number IRHM58Z60

International Rectifier radiation hardened MOSFETs have been characterized in heavy ion environment for Single Event Effects (SEE). Single Event Effects characterization is illustrated in Fig. a and Table 2.

Table 2. Single Event Effect Safe Operating Area

Ion	LET MeV/(mg/cm ²)	Energy (MeV)	Range (μm)	V _{DS} (V)				
				@ V _{GS} =0V	@ V _{GS} =-5V	@ V _{GS} =-10V	@ V _{GS} =-15V	@ V _{GS} =-20V
Br	37.9	255	33.4	30	30	30	25	20
I	59.4	290	28.8	25	25	20	15	10
Au	80.3	313	26.5	22.5	22.5	15	10	—

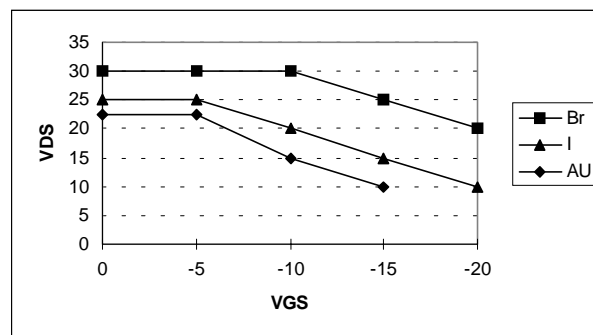

Fig a. Single Event Effect, Safe Operating Area

For footnotes refer to the last page

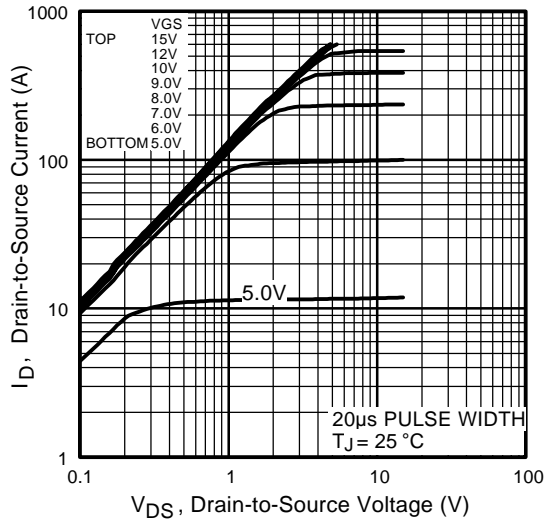

Fig 1. Typical Output Characteristics

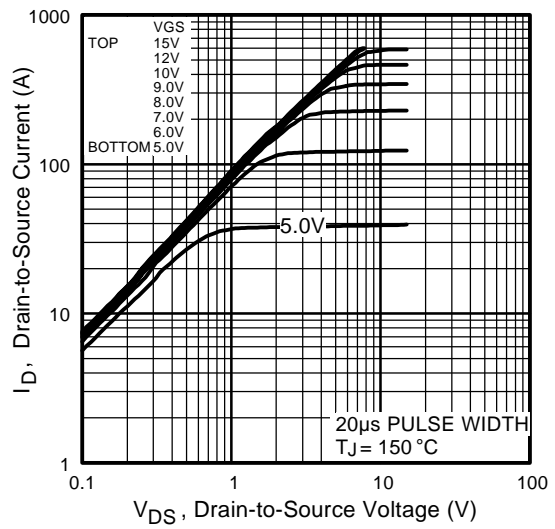

Fig 2. Typical Output Characteristics

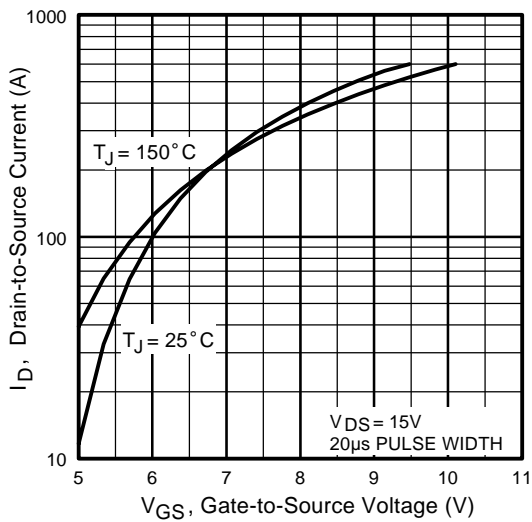

Fig 3. Typical Transfer Characteristics

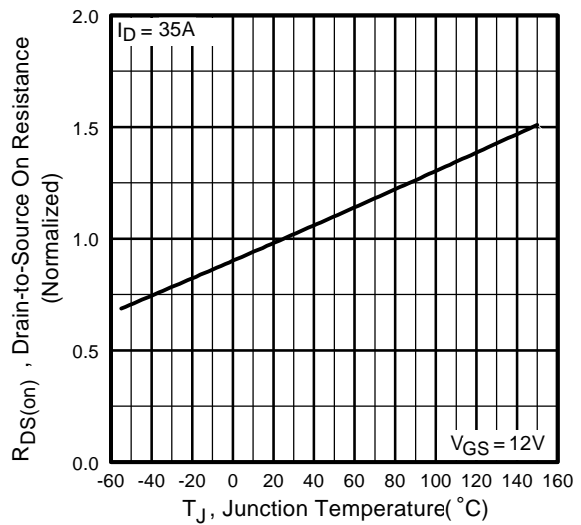

Fig 4. Normalized On-Resistance Vs. Temperature

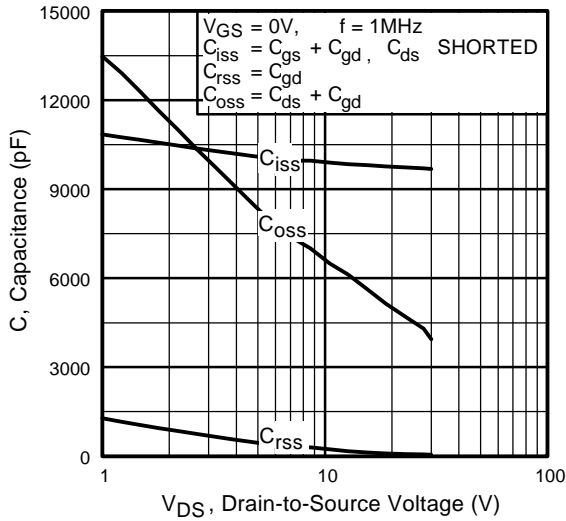

Fig 5. Typical Capacitance Vs. Drain-to-Source Voltage

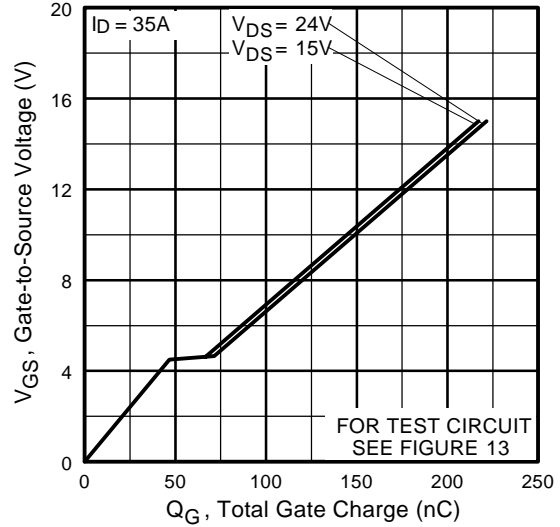

Fig 6. Typical Gate Charge Vs. Gate-to-Source Voltage

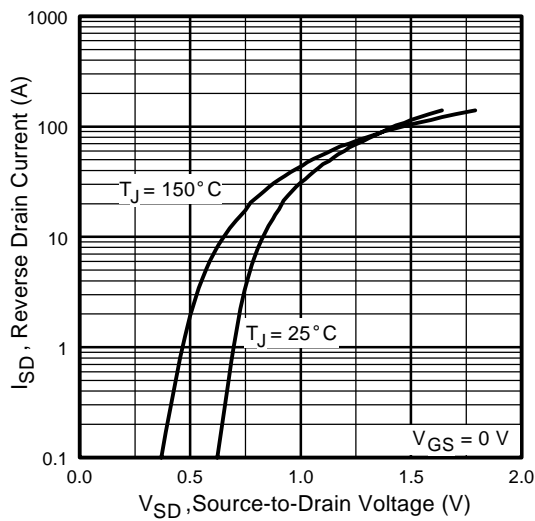

Fig 7. Typical Source-Drain Diode Forward Voltage

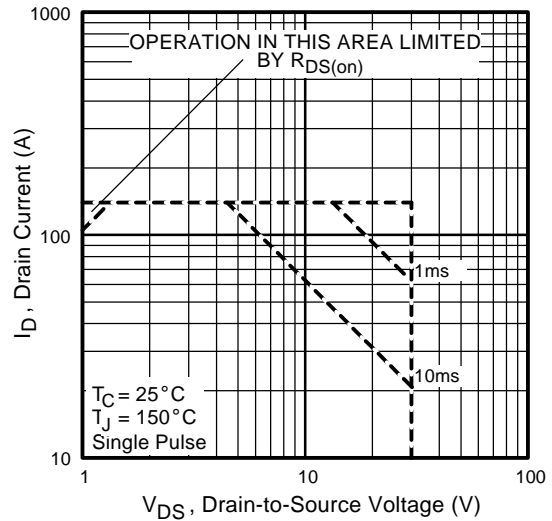

Fig 8. Maximum Safe Operating Area

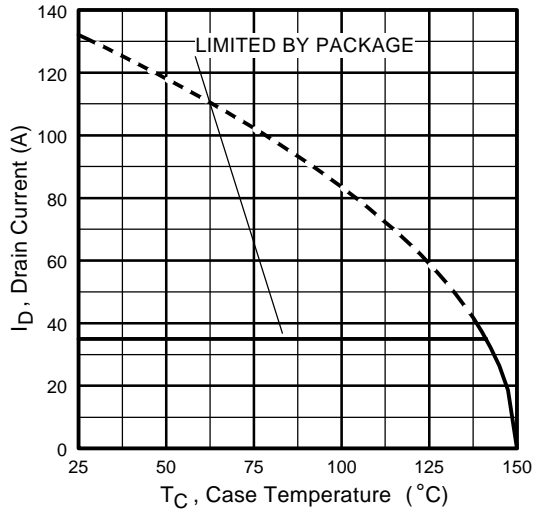

Fig 9. Maximum Drain Current Vs. Case Temperature

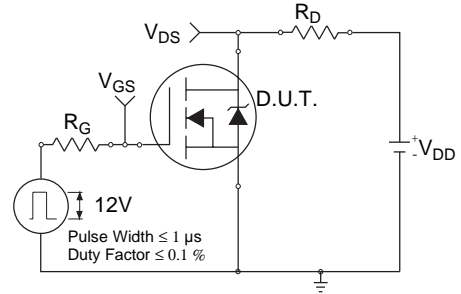

Fig 10a. Switching Time Test Circuit

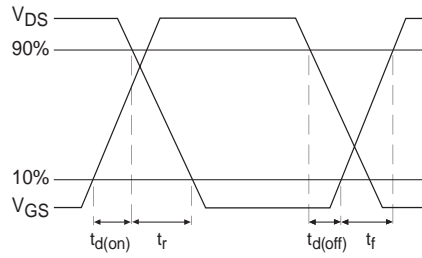

Fig 10b. Switching Time Waveforms

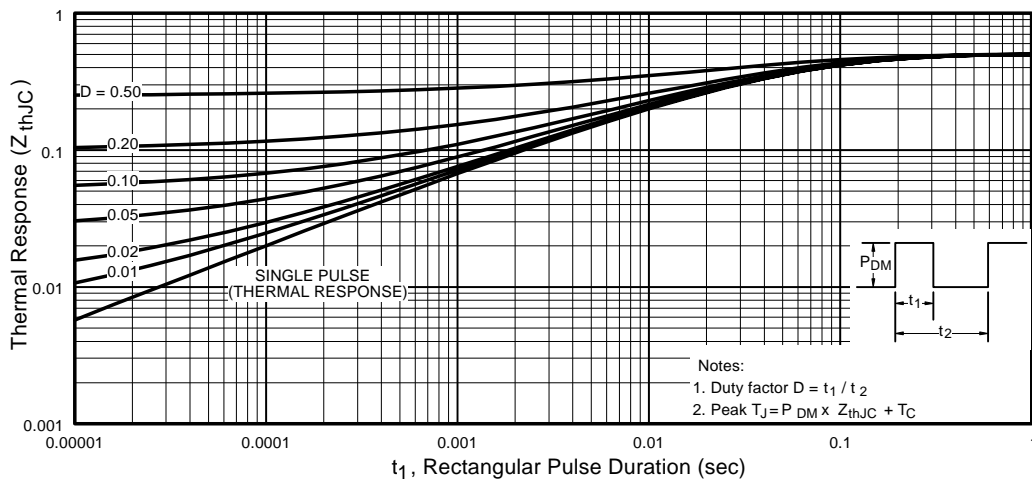

Fig 11. Maximum Effective Transient Thermal Impedance, Junction-to-Case

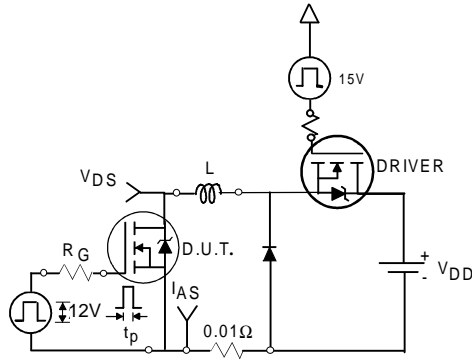

Fig 12a. Unclamped Inductive Test Circuit

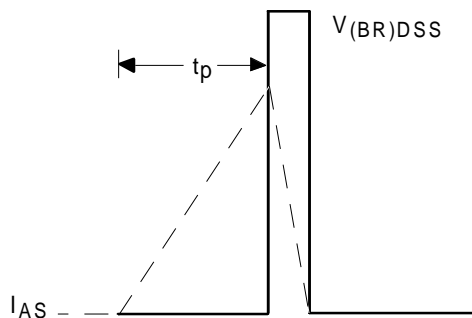

Fig 12b. Unclamped Inductive Waveforms

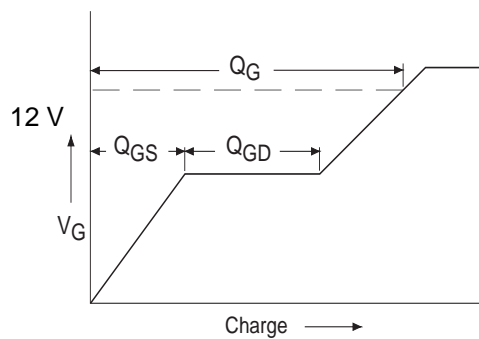

Fig 13a. Basic Gate Charge Waveform

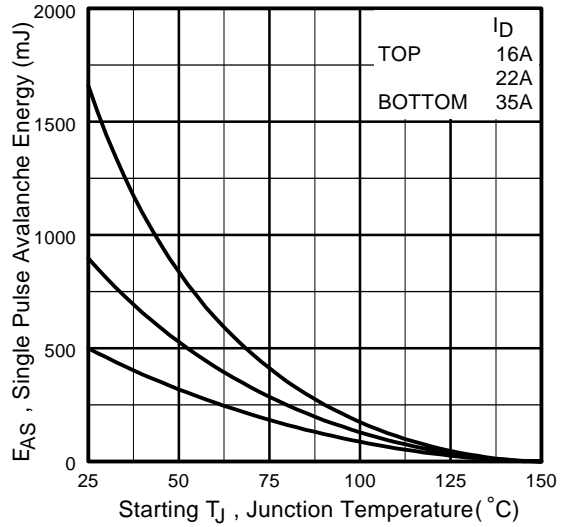

Fig 12c. Maximum Avalanche Energy Vs. Drain Current

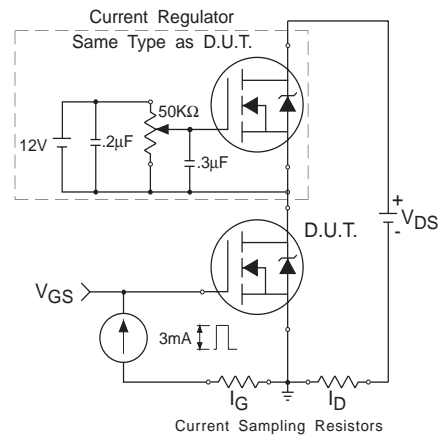
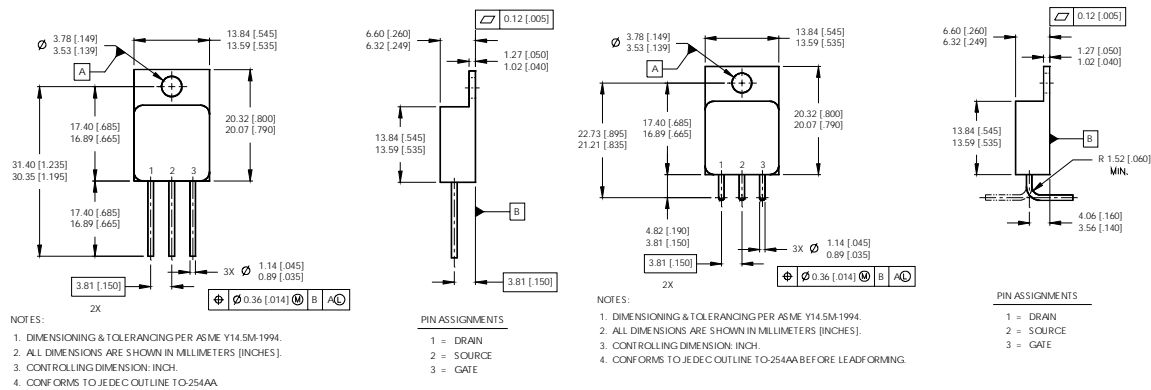

Fig 13b. Gate Charge Test Circuit

Footnotes:

- ① Repetitive Rating; Pulse width limited by maximum junction temperature.
- ② $V_{DD} = 25V$, starting $T_J = 25^\circ C$, $L = 0.8\text{ mH}$
Peak $I_L = 35A$, $V_{GS} = 12V$
- ③ $I_{SD} \leq 35A$, $di/dt \leq 132A/\mu s$,
 $V_{DD} \leq 30V$, $T_J \leq 150^\circ C$
- ④ Pulse width $\leq 300\ \mu s$; Duty Cycle $\leq 2\%$
- ⑤ **Total Dose Irradiation with V_{GS} Bias.**
12 volt V_{GS} applied and $V_{DS} = 0$ during irradiation per MIL-STD-750, method 1019, condition A.
- ⑥ **Total Dose Irradiation with V_{DS} Bias.**
24 volt V_{DS} applied and $V_{GS} = 0$ during irradiation per MIL-STD-750, method 1019, condition A.

Case Outline and Dimensions — TO-254AA



CAUTION

BERYLLIA WARNING PER MIL-PRF-19500

Packages containing beryllia shall not be ground, sandblasted, machined, or have other operations performed on them which will produce beryllia or beryllium dust. Furthermore, beryllium oxide packages shall not be placed in acids that will produce fumes containing beryllium.



IR WORLD HEADQUARTERS: 233 Kansas St., El Segundo, California 90245, USA Tel: (310) 252-7105
IR EUROPEAN REGIONAL CENTRE: 439/445 Godstone Rd, Whyteleafe, Surrey CR3 OBL, UK Tel: ++ 44 (0)20 8645 8000
IR CANADA: 15 Lincoln Court, Brampton, Ontario L6T3Z2, Tel: (905) 453 2200
IR GERMANY: Saalburgstrasse 157, 61350 Bad Homburg Tel: ++ 49 (0) 6172 96590
IR ITALY: Via Liguria 49, 10071 Borgaro, Torino Tel: ++ 39 011 451 0111
IR JAPAN: K&H Bldg., 2F, 30-4 Nishi-Ikebukuro 3-Chome, Toshima-Ku, Tokyo 171 Tel: 81 (0)3 3983 0086
IR SOUTHEAST ASIA: 1 Kim Seng Promenade, Great World City West Tower, 13-11, Singapore 237994 Tel: ++ 65 (0)838 4630
IR TAIWAN: 16 Fl. Suite D. 207, Sec. 2, Tun Haw South Road, Taipei, 10673 Tel: 886-(0)2 2377 9936
Data and specifications subject to change without notice. 4/00