

# International IR Rectifier

PD - 90888B

## RADIATION HARDENED POWER MOSFET THRU-HOLE (TO-254AA)

## IRHM9130 100V, P-CHANNEL RAD-Hard™ HEXFET® TECHNOLOGY

### Product Summary

Part Number	Radiation Level	RDS(on)	ID
IRHM9130	100K Rads (Si)	0.3Ω	-11A
IRHM93130	300K Rads (Si)	0.3Ω	-11A



International Rectifier's RAD-Hard HEXFET™ technology provides high performance power MOSFETs for space applications. This technology has over a decade of proven performance and reliability in satellite applications. These devices have been characterized for both Total Dose and Single Event Effects (SEE). The combination of low Rds(on) and low gate charge reduces the power losses in switching applications such as DC to DC converters and motor control. These devices retain all of the well established advantages of MOSFETs such as voltage control, fast switching, ease of paralleling and temperature stability of electrical parameters.

### Features:

- Single Event Effect (SEE) Hardened
- Low RDS(on)
- Low Total Gate Charge
- Proton Tolerant
- Simple Drive Requirements
- Ease of Paralleling
- Hermetically Sealed
- Ceramic Package
- Light Weight

### Absolute Maximum Ratings

### Pre-Irradiation

	Parameter		Units
ID @ VGS = -12V, TC = 25°C	Continuous Drain Current	-11	A
ID @ VGS = -12V, TC = 100°C	Continuous Drain Current	-7.0	
IDM	Pulsed Drain Current ①	-44	
PD @ TC = 25°C	Max. Power Dissipation	75	W
	Linear Derating Factor	0.6	W/°C
VGS	Gate-to-Source Voltage	±20	V
EAS	Single Pulse Avalanche Energy ②	190	mJ
IAR	Avalanche Current ①	-11	A
EAR	Repetitive Avalanche Energy ①	7.5	mJ
dv/dt	Peak Diode Recovery dv/dt ③	-10	V/ns
TJ	Operating Junction	-55 to 150	°C
TSTG	Storage Temperature Range		
	Lead Temperature	300 ( 0.063 in. (1.6mm) from case for 10s)	
	Weight	9.3 (typical)	g

For footnotes refer to the last page



**Electrical Characteristics @ T<sub>j</sub> = 25°C (Unless Otherwise Specified)**

	Parameter	Min	Typ	Max	Units	Test Conditions
B <sub>V</sub> DSS	Drain-to-Source Breakdown Voltage	-100	—	—	V	V <sub>GS</sub> = 0V, I <sub>D</sub> = -1.0mA
ΔB <sub>V</sub> DSS/ΔT <sub>J</sub>	Temperature Coefficient of Breakdown Voltage	—	-0.1	—	V/°C	Reference to 25°C, I <sub>D</sub> = -1.0mA
R <sub>DS(on)</sub>	Static Drain-to-Source On-State Resistance	—	—	0.3	Ω	V <sub>GS</sub> = -12V, I <sub>D</sub> = -7.0A④
		—	—	0.325		V <sub>GS</sub> = -12V, I <sub>D</sub> = -11A④
V <sub>GS(th)</sub>	Gate Threshold Voltage	-2.0	—	-4.0	V	V <sub>DS</sub> = V <sub>GS</sub> , I <sub>D</sub> = -1.0mA
g <sub>fs</sub>	Forward Transconductance	2.5	—	—	S (S)	V <sub>DS</sub> > -15V, I <sub>DS</sub> = -7.0A ④
I <sub>DSS</sub>	Zero Gate Voltage Drain Current	—	—	-25	μA	V <sub>DS</sub> = -80V, V <sub>GS</sub> = 0V
		—	—	-250		V <sub>DS</sub> = -80V, V <sub>GS</sub> = 0V, T <sub>J</sub> = 125°C
I <sub>GSS</sub>	Gate-to-Source Leakage Forward	—	—	-100	nA	V <sub>GS</sub> = -20V
I <sub>GSS</sub>	Gate-to-Source Leakage Reverse	—	—	100	nA	V <sub>GS</sub> = 20V
Q <sub>g</sub>	Total Gate Charge	—	—	45	nC	V <sub>GS</sub> = -12V, I <sub>D</sub> = -11A V <sub>DS</sub> = -50V
Q <sub>gs</sub>	Gate-to-Source Charge	—	—	10		
Q <sub>gd</sub>	Gate-to-Drain ('Miller') Charge	—	—	25		
t <sub>d(on)</sub>	Turn-On Delay Time	—	—	30	ns	V <sub>DD</sub> = -50V, I <sub>D</sub> = -11A, V <sub>GS</sub> = -12V, R <sub>G</sub> = 7.5Ω
t <sub>r</sub>	Rise Time	—	—	50		
t <sub>d(off)</sub>	Turn-Off Delay Time	—	—	70		
t <sub>f</sub>	Fall Time	—	—	70		
LS + LD	Total Inductance	—	6.8	—	nH	Measured from drain lead (6mm/0.25in. from package) to source lead (6mm/0.25in. from package)
C <sub>iss</sub>	Input Capacitance	—	1200	—	pF	V <sub>GS</sub> = 0V, V <sub>DS</sub> = -25V f = 1.0MHz
C <sub>oss</sub>	Output Capacitance	—	300	—		
C <sub>rss</sub>	Reverse Transfer Capacitance	—	74	—		

**Source-Drain Diode Ratings and Characteristics**

	Parameter	Min	Typ	Max	Units	Test Conditions
I <sub>S</sub>	Continuous Source Current (Body Diode)	—	—	-11	A	
I <sub>SM</sub>	Pulse Source Current (Body Diode) ①	—	—	-44		
V <sub>SD</sub>	Diode Forward Voltage	—	—	-3.0	V	T <sub>j</sub> = 25°C, I <sub>S</sub> = -11A, V <sub>GS</sub> = 0V ④
t <sub>rr</sub>	Reverse Recovery Time	—	—	250	nS	T <sub>j</sub> = 25°C, I <sub>F</sub> = -11A, di/dt ≤ -100A/μs
Q <sub>RR</sub>	Reverse Recovery Charge	—	—	0.84	μC	V <sub>DD</sub> ≤ -50V ④
t <sub>on</sub>	Forward Turn-On Time	Intrinsic turn-on time is negligible. Turn-on speed is substantially controlled by LS + LD.				

**Thermal Resistance**

	Parameter	Min	Typ	Max	Units	Test Conditions
R <sub>thJC</sub>	Junction-to-Case	—	—	1.67	°C/W	Typical socket mount
R <sub>thCS</sub>	Case-to-Sink	—	0.21	—		
R <sub>thJA</sub>	Junction-to-Ambient	—	—	30		

Note: Corresponding Spice and Saber models are available on the G&S Website.

For footnotes refer to the last page

## Radiation Characteristics

IRHM9130

International Rectifier Radiation Hardened MOSFETs are tested to verify their radiation hardness capability. The hardness assurance program at International Rectifier is comprised of two radiation environments. Every manufacturing lot is tested for total ionizing dose (per notes 5 and 6) using the TO-3 package. Both pre- and post-irradiation performance are tested and specified using the same drive circuitry and test conditions in order to provide a direct comparison.

**Table 1. Electrical Characteristics @ Tj = 25°C, Post Total Dose Irradiation ⑤⑥**

	Parameter	100K Rads(Si) <sup>1</sup>		300K Rads (Si) <sup>2</sup>		Units	Test Conditions
		Min	Max	Min	Max		
BV <sub>DSS</sub>	Drain-to-Source Breakdown Voltage	-100	—	-100	—	V	V <sub>GS</sub> = 0V, I <sub>D</sub> = -1.0mA
V <sub>GS(th)</sub>	Gate Threshold Voltage	-2.0	-4.0	-2.0	-5.0		V <sub>GS</sub> = V <sub>DS</sub> , I <sub>D</sub> = -1.0mA
I <sub>GSS</sub>	Gate-to-Source Leakage Forward	—	-100	—	-100	nA	V <sub>GS</sub> = -20V
I <sub>GSS</sub>	Gate-to-Source Leakage Reverse	—	100	—	100		V <sub>GS</sub> = 20 V
I <sub>DSS</sub>	Zero Gate Voltage Drain Current	—	-25	—	-25	μA	V <sub>DS</sub> = -80V, V <sub>GS</sub> = 0V
R <sub>DS(on)</sub>	Static Drain-to-Source ④ On-State Resistance (TO-3)	—	0.3	—	0.3	Ω	V <sub>GS</sub> = -12V, I <sub>D</sub> = -7A
R <sub>DS(on)</sub>	Static Drain-to-Source ④ On-State Resistance (TO-254AA)	—	0.3	—	0.3	Ω	V <sub>GS</sub> = -12V, I <sub>D</sub> = -7A
V <sub>SD</sub>	Diode Forward Voltage ④	—	-3.0	—	-3.0	V	V <sub>GS</sub> = 0V, I <sub>S</sub> = -11A

1. Part number IRHM9130

2. Part number IRHM93130

International Rectifier radiation hardened MOSFETs have been characterized in heavy ion environment for Single Event Effects (SEE). Single Event Effects characterization is illustrated in Fig. a and Table 2.

**Table 2. Single Event Effect Safe Operating Area**

Ion	LET MeV/(mg/cm <sup>2</sup> )	Energy (MeV)	Range (μm)	V <sub>DS</sub> (V)				
				@V <sub>GS</sub> =0V	@V <sub>GS</sub> =5V	@V <sub>GS</sub> =10V	@V <sub>GS</sub> =15V	@V <sub>GS</sub> =20V
Cu	28	285	43	-100	-100	-100	-70	-60
Br	36.8	305	39	-100	-100	-70	-50	-40
I	59.9	345	32.8	-60	—	—	—	—

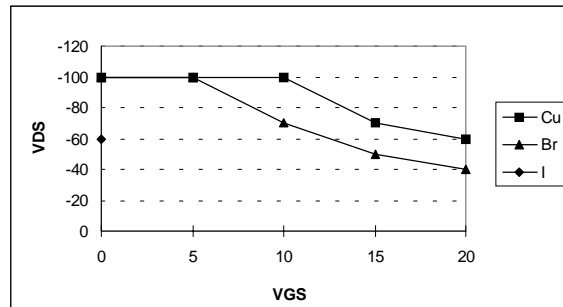

**Fig a. Single Event Effect, Safe Operating Area**

For footnotes refer to the last page

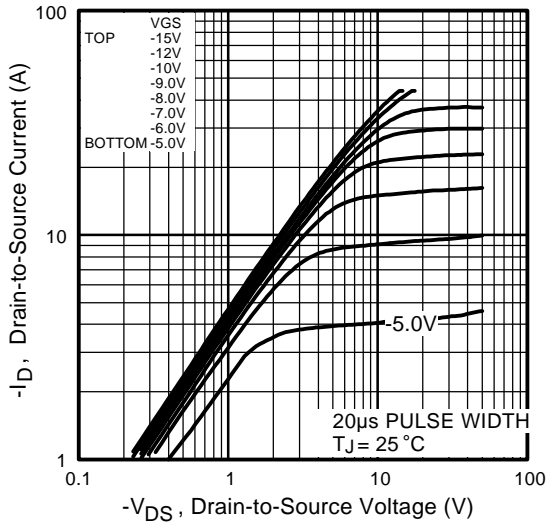

Fig1. Typical Output Characteristics

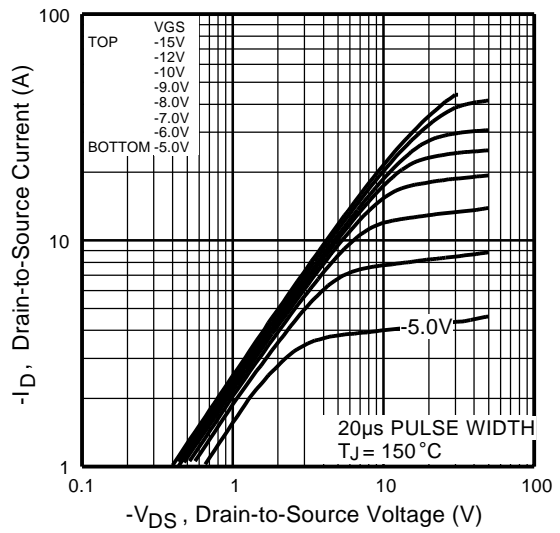

Fig2. Typical Output Characteristics

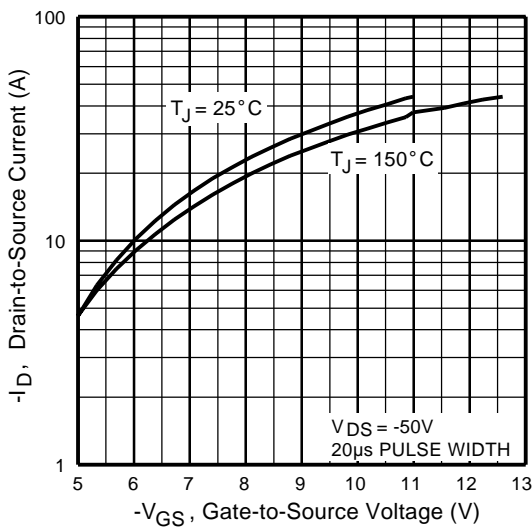

Fig3. Typical Transfer Characteristics

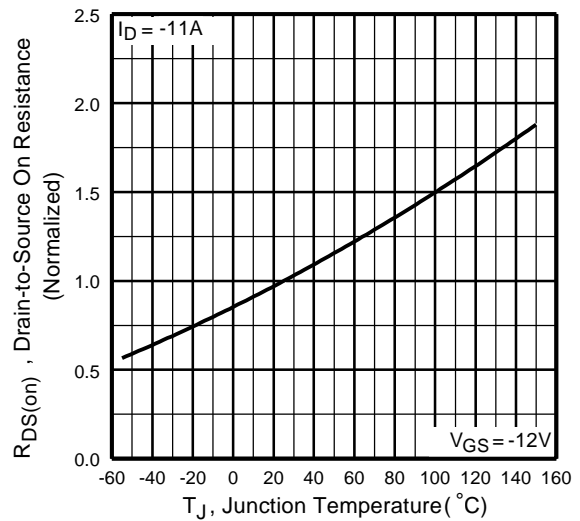
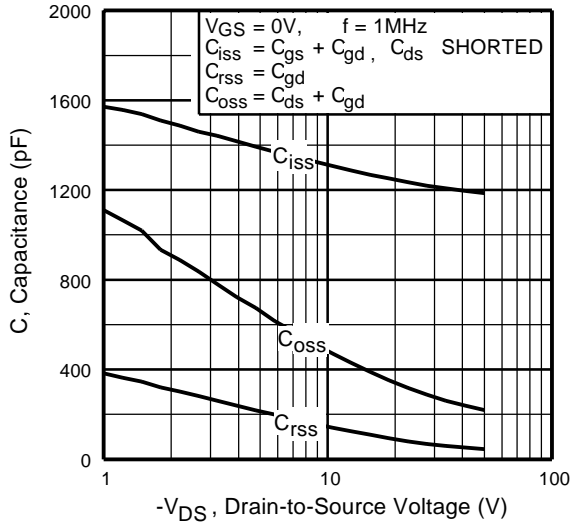
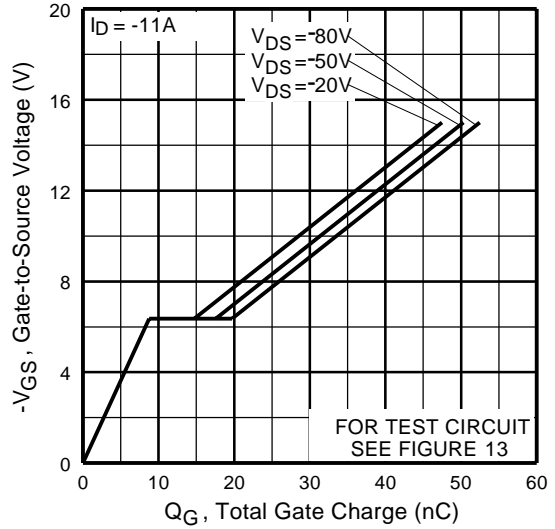

Fig4. Normalized On-Resistance Vs. Temperature



**Fig5.** Typical Capacitance Vs. Drain-to-Source Voltage



**Fig6.** Typical Gate Charge Vs. Gate-to-Source Voltage

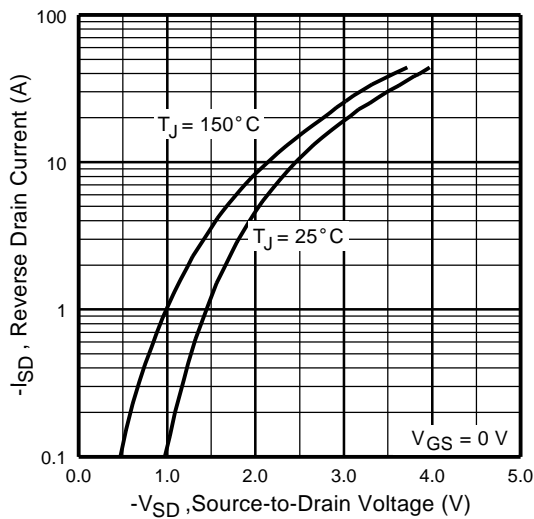

**Fig7.** Typical Source-Drain Diode Forward Voltage

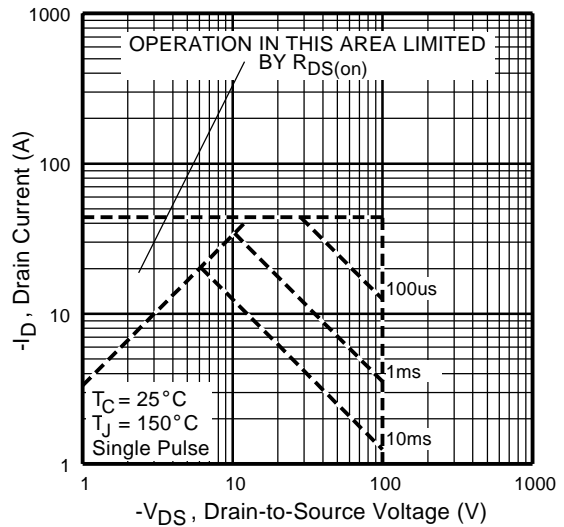

**Fig8.** Maximum Safe Operating Area

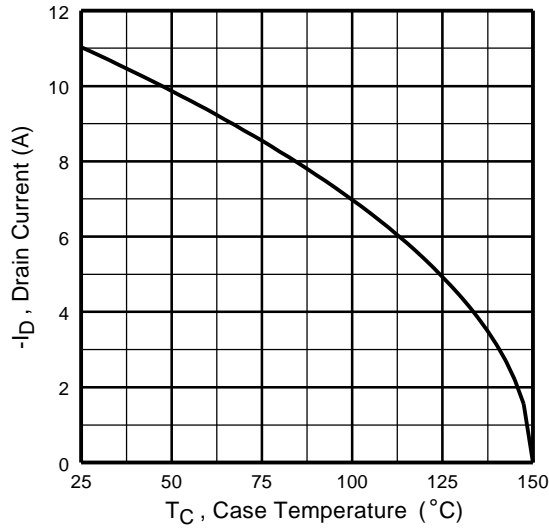

Fig9. Maximum Drain Current Vs. Case Temperature

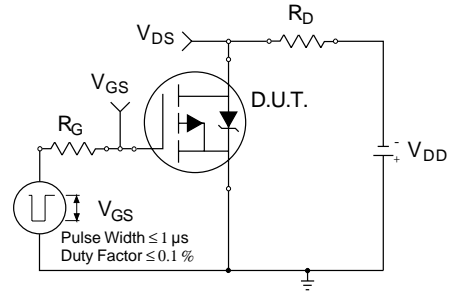

Fig 10a. Switching Time Test Circuit

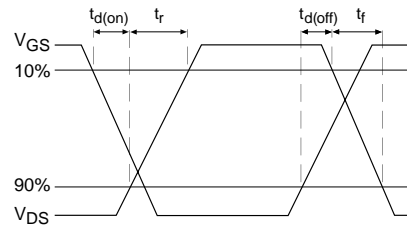

Fig 10b. Switching Time Waveforms

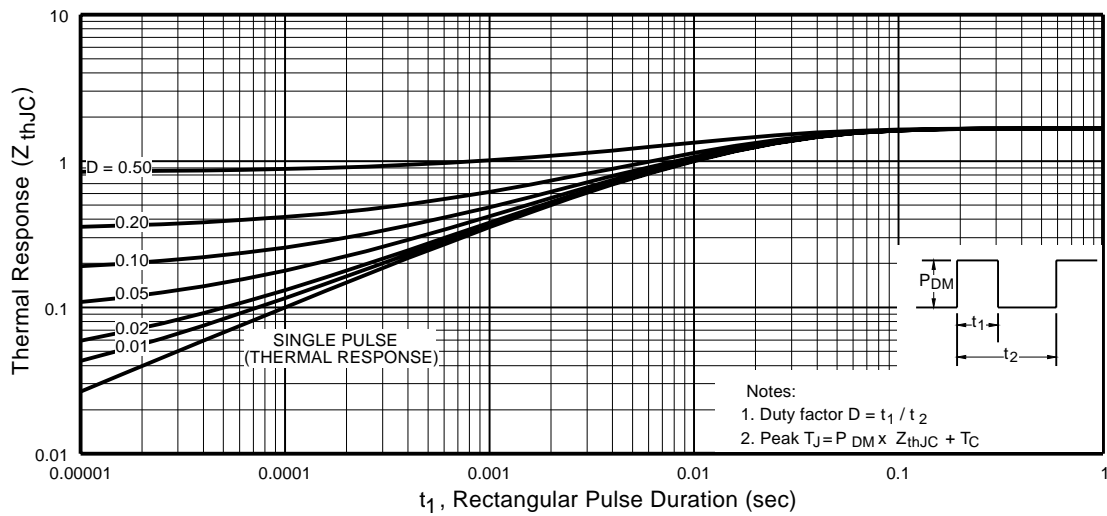

Fig 11. Maximum Effective Transient Thermal Impedance, Junction-to-Case

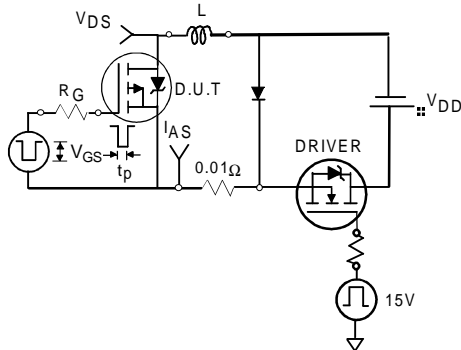

Fig 12a. Unclamped Inductive Test Circuit

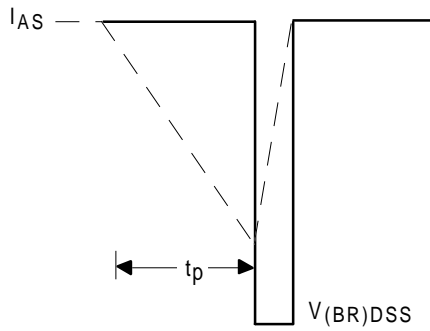

Fig 12b. Unclamped Inductive Waveforms

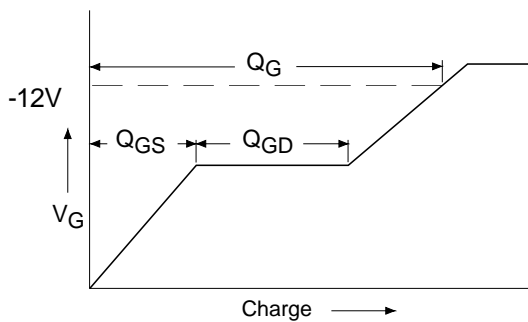

Fig 13a. Basic Gate Charge Waveform

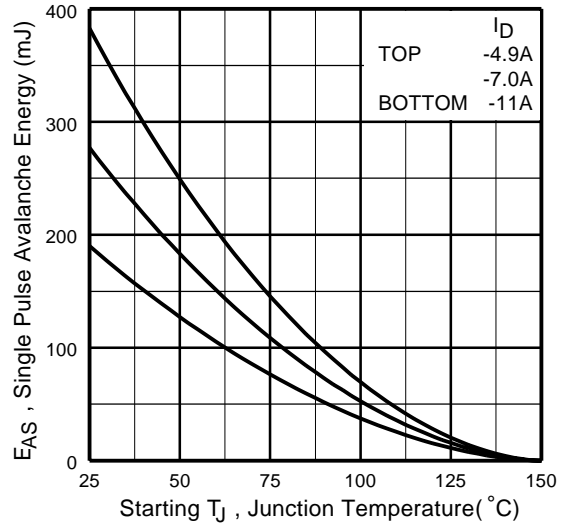

Fig 12c. Maximum Avalanche Energy Vs. Drain Current

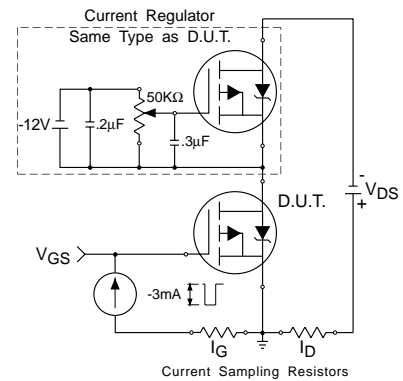

Fig 13b. Gate Charge Test Circuit

## IRHM9130

## Pre-Irradiation

### Foot Notes:

- ① Repetitive Rating; Pulse width limited by maximum junction temperature.
- ②  $V_{DD} = -25V$ , starting  $T_J = 25^\circ C$ ,  $L=3.1mH$   
Peak  $I_L = -11A$ ,  $V_{GS} = -12V$
- ③  $I_{SD} \leq -11A$ ,  $di/dt \leq -480A/\mu s$ ,  
 $V_{DD} \leq -100V$ ,  $T_J \leq 150^\circ C$
- ④ Pulse width  $\leq 300 \mu s$ ; Duty Cycle  $\leq 2\%$
- ⑤ **Total Dose Irradiation with  $V_{GS}$  Bias.**  
12 volt  $V_{GS}$  applied and  $V_{DS} = 0$  during irradiation per MIL-STD-750, method 1019, condition A.
- ⑥ **Total Dose Irradiation with  $V_{DS}$  Bias.**  
-80 volt  $V_{DS}$  applied and  $V_{GS} = 0$  during irradiation per MIL-STD-750, method 1019, condition A.

### Case Outline and Dimensions — TO-254AA

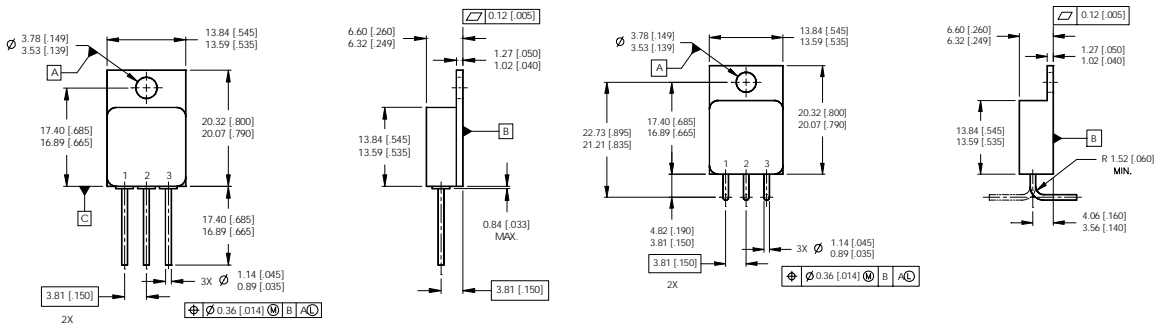

NOTES:  
 1. DIMENSIONING & TOLERANCING PER ASME Y14.5M-1994.  
 2. ALL DIMENSIONS ARE SHOWN IN MILLIMETERS (INCHES).  
 3. CONTROLLING DIMENSION: INCH.  
 4. CONFORMS TO JEDEC OUTLINE TO-254AA.

PIN ASSIGNMENTS  
 1 = DRAIN  
 2 = SOURCE  
 3 = GATE

### CAUTION

#### BERYLLIA WARNING PER MIL-PRF-19500

Packages containing beryllia shall not be ground, sandblasted, machined or have other operations performed on them which will produce beryllia or beryllium dust. Furthermore, beryllium oxide packages shall not be placed in acids that will produce fumes containing beryllium.

International  
**IR** Rectifier

IR WORLD HEADQUARTERS: 233 Kansas St., El Segundo, California 90245, USA Tel: (310) 252-7105  
 TAC Fax: (310) 252-7903

Visit us at [www.irf.com](http://www.irf.com) for sales contact information.  
 Data and specifications subject to change without notice. 01/02