

- Advanced Process Technology
- Surface Mount
- Optimized for 4.5V-7.0V Gate Drive
- Ideal for CPU Core DC-DC Converters
- Fast Switching

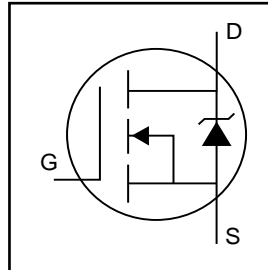

$V_{DSS} = 20V$
$R_{DS(on)} = 0.01\Omega$
$I_D = 85A\text{⑥}$

Description

These HEXFET Power MOSFETs were designed specifically to meet the demands of CPU core DC-DC converters. Advanced processing techniques combined with an optimized gate oxide design results in a die sized specifically to offer maximum efficiency at minimum cost.

The D²Pak is a surface mount power package capable of accommodating die sizes up to HEX-4. It provides the highest power capability and the lowest possible on-resistance in any existing surface mount package. The D²Pak is suitable for high current applications because of its low internal connection resistance and can dissipate up to 2.0W in a typical surface mount application.

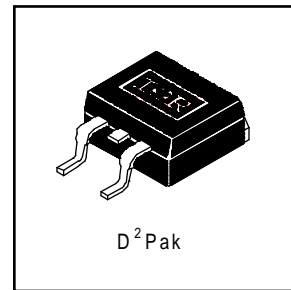

Absolute Maximum Ratings

	Parameter	Max.	Units
$I_D @ T_C = 25^\circ C$	Continuous Drain Current, $V_{GS} @ 4.5V\text{⑤}$	85⑥	A
$I_D @ T_C = 100^\circ C$	Continuous Drain Current, $V_{GS} @ 4.5V\text{⑤}$	54	
I_{DM}	Pulsed Drain Current ①⑤	340	
$P_D @ T_C = 25^\circ C$	Power Dissipation	110	W
	Linear Derating Factor	0.91	W/°C
V_{GS}	Gate-to-Source Voltage	± 10	V
V_{GSM}	Gate-to-Source Voltage (Start Up Transient, $t_p = 100\mu s$)	14	V
E_{AS}	Single Pulse Avalanche Energy②⑤	290	mJ
I_{AR}	Avalanche Current①	51	A
E_{AR}	Repetitive Avalanche Energy①	11	mJ
dv/dt	Peak Diode Recovery dv/dt ③⑤	5.0	V/ns
T_J	Operating Junction and	-55 to + 150	°C
T_{STG}	Storage Temperature Range		
	Soldering Temperature, for 10 seconds	300 (1.6mm from case)	

Thermal Resistance

	Parameter	Typ.	Max.	Units
$R_{\theta JC}$	Junction-to-Case	—	1.1	°C/W
$R_{\theta JA}$	Junction-to-Ambient (PCB Mounted,steady-state)**	—	40	

Electrical Characteristics @ $T_J = 25^\circ\text{C}$ (unless otherwise specified)

	Parameter	Min.	Typ.	Max.	Units	Conditions
$V_{(BR)DSS}$	Drain-to-Source Breakdown Voltage	20	—	—	V	$V_{GS} = 0V, I_D = 250\mu A$
$\Delta V_{(BR)DSS}/\Delta T_J$	Breakdown Voltage Temp. Coefficient	—	0.02	—	V/ $^\circ\text{C}$	Reference to 25°C , $I_D = 1\text{mA}$ ⑤
$R_{DS(on)}$	Static Drain-to-Source On-Resistance	—	—	0.010	Ω	$V_{GS} = 4.5V, I_D = 51A$ ④
		—	—	0.008		$V_{GS} = 7.0V, I_D = 51A$ ④
$V_{GS(th)}$	Gate Threshold Voltage	0.70	—	—	V	$V_{DS} = V_{GS}, I_D = 250\mu A$
g_{fs}	Forward Transconductance	65	—	—	S	$V_{DS} = 10V, I_D = 51A$ ⑤
I_{DSS}	Drain-to-Source Leakage Current	—	—	25	μA	$V_{DS} = 20V, V_{GS} = 0V$
		—	—	250		$V_{DS} = 16V, V_{GS} = 0V, T_J = 150^\circ\text{C}$
I_{GSS}	Gate-to-Source Forward Leakage	—	—	100	nA	$V_{GS} = 10V$
	Gate-to-Source Reverse Leakage	—	—	-100		$V_{GS} = -10V$
Q_g	Total Gate Charge	—	—	78	nC	$I_D = 51A$
Q_{gs}	Gate-to-Source Charge	—	—	18		$V_{DS} = 10V$
Q_{gd}	Gate-to-Drain ("Miller") Charge	—	—	30		$V_{GS} = 4.5V$, See Fig. 6 ④⑤
$t_{d(on)}$	Turn-On Delay Time	—	10	—	ns	$V_{DD} = 10V$
t_r	Rise Time	—	140	—		$I_D = 51A$
$t_{d(off)}$	Turn-Off Delay Time	—	80	—		$R_G = 5.0\Omega, V_{GS} = 4.5V$
t_f	Fall Time	—	120	—		$R_D = 0.19\Omega$, ④⑤
L_S	Internal Source Inductance	—	7.5	—	nH	Between lead, and center of die contact
C_{iss}	Input Capacitance	—	3300	—	pF	$V_{GS} = 0V$
C_{oss}	Output Capacitance	—	1400	—		$V_{DS} = 15V$
C_{rss}	Reverse Transfer Capacitance	—	510	—		$f = 1.0\text{MHz}$, See Fig. 5⑤

Source-Drain Ratings and Characteristics

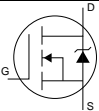
	Parameter	Min.	Typ.	Max.	Units	Conditions
I_S	Continuous Source Current (Body Diode)	—	—	85	A	MOSFET symbol showing the integral reverse p-n junction diode. 
I_{SM}	Pulsed Source Current (Body Diode) ①⑤	—	—	340		
V_{SD}	Diode Forward Voltage	—	—	1.3	V	$T_J = 25^\circ\text{C}, I_S = 51A, V_{GS} = 0V$ ④
t_{rr}	Reverse Recovery Time	—	72	110	ns	$T_J = 25^\circ\text{C}, I_F = 51A$
Q_{rr}	Reverse Recovery Charge	—	160	240	nC	$di/dt = 100A/\mu s$ ④⑤
t_{on}	Forward Turn-On Time	Intrinsic turn-on time is negligible (turn-on is dominated by L_S+L_D)				

Notes:

- ① Repetitive rating; pulse width limited by max. junction temperature.
- ② Starting $T_J = 25^\circ\text{C}$, $L = 0.55\text{ mH}$
 $R_G = 25\Omega, I_{AS} = 51A$.
- ③ $I_{SD} \leq 51A, di/dt \leq 82A/\mu s, V_{DD} \leq V_{(BR)DSS}, T_J \leq 150^\circ\text{C}$
- ④ Pulse width $\leq 300\mu s$; duty cycle $\leq 2\%$.
- ⑤ Uses IRL3402 data and test conditions
- ⑥ Calculated continuous current based on maximum allowable junction temperature; for recommended current-handling of the package refer to Design Tip # 93-4

** When mounted on FR-4 board using minimum recommended footprint.
For recommended footprint and soldering techniques refer to application note #AN-994.

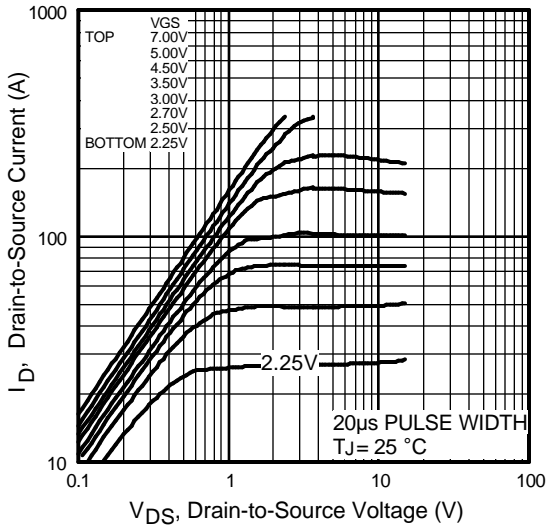

Fig 1. Typical Output Characteristics

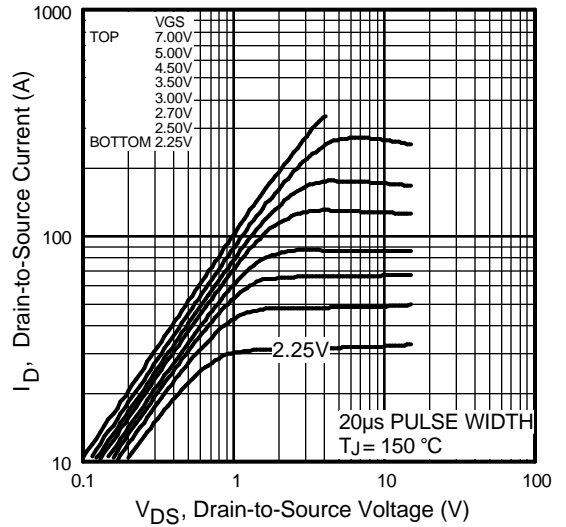

Fig 2. Typical Output Characteristics

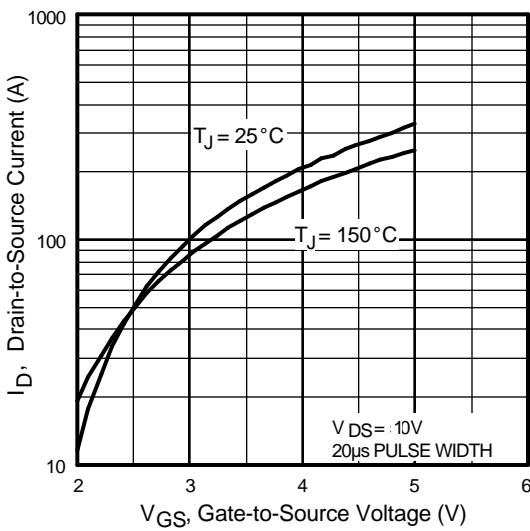

Fig 3. Typical Transfer Characteristics

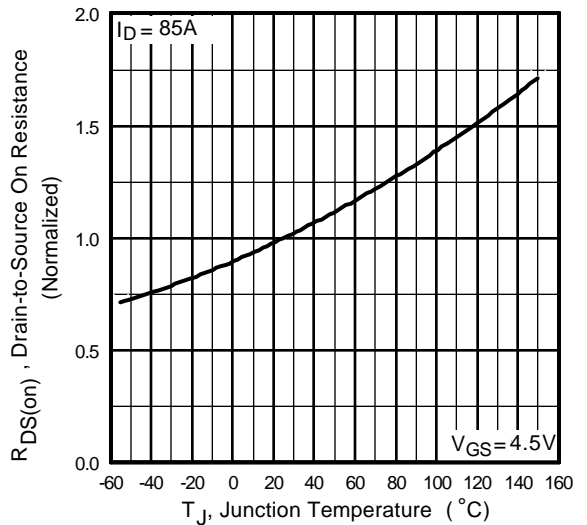

Fig 4. Normalized On-Resistance Vs. Temperature

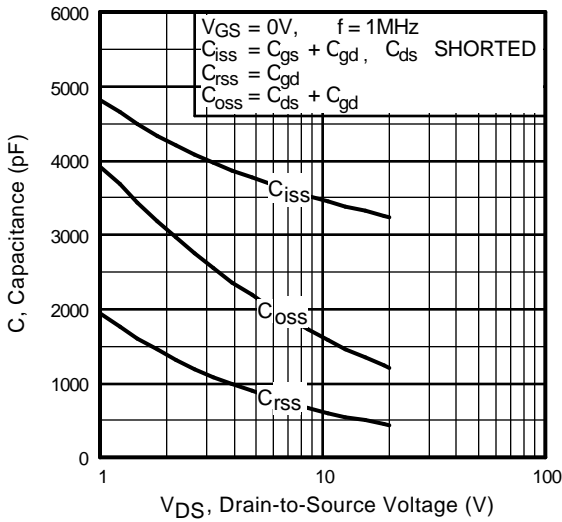

Fig 5. Typical Capacitance Vs. Drain-to-Source Voltage

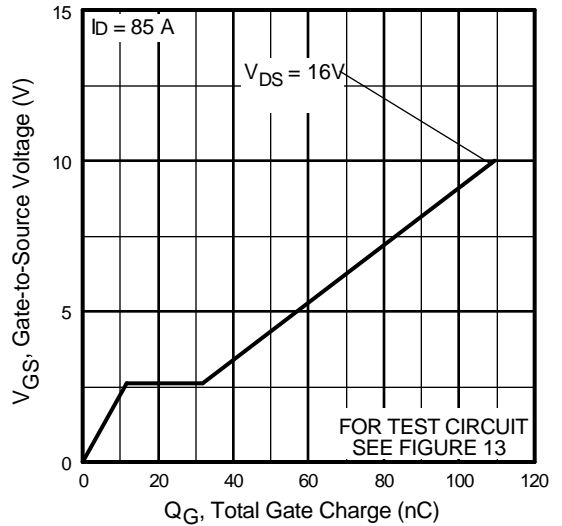

Fig 6. Typical Gate Charge Vs. Gate-to-Source Voltage

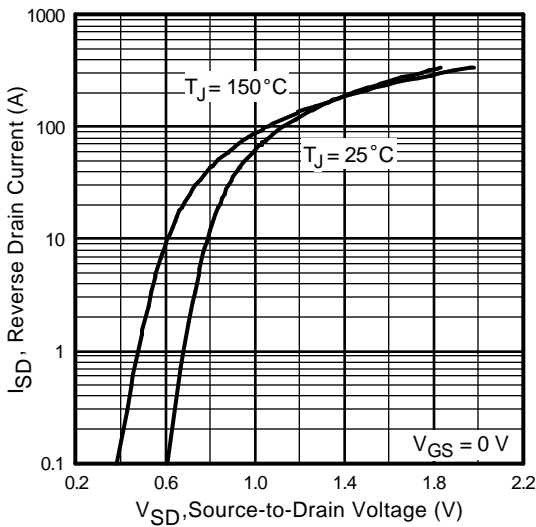

Fig 7. Typical Source-Drain Diode Forward Voltage

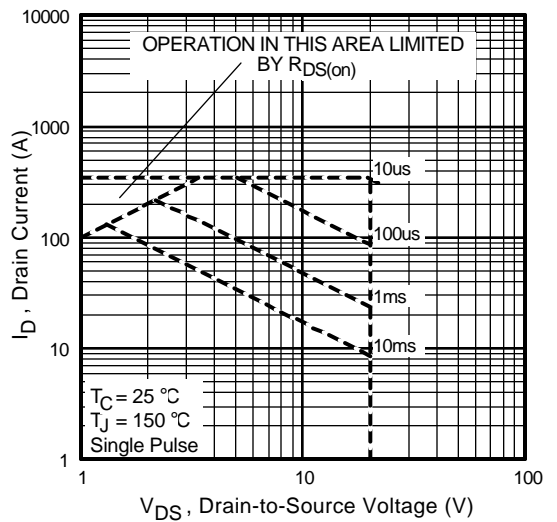

Fig 8. Maximum Safe Operating Area

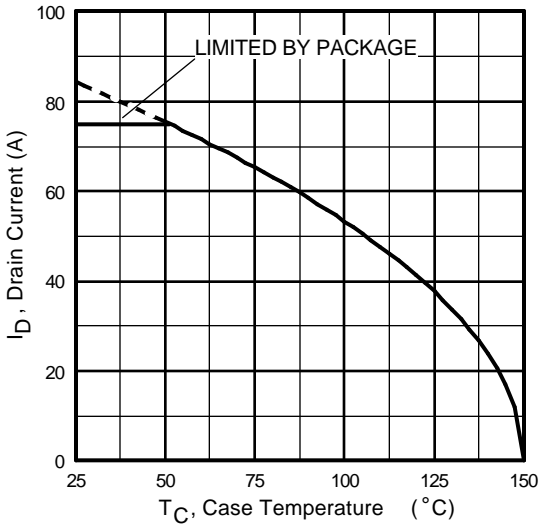

Fig 9. Maximum Drain Current Vs. Case Temperature

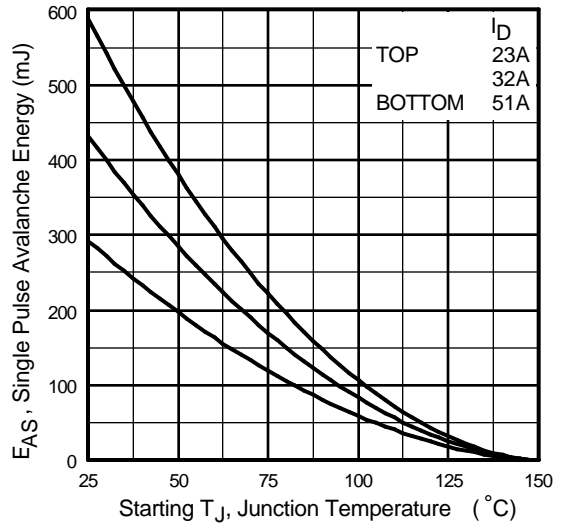

Fig 10. Maximum Avalanche Energy Vs. Drain Current

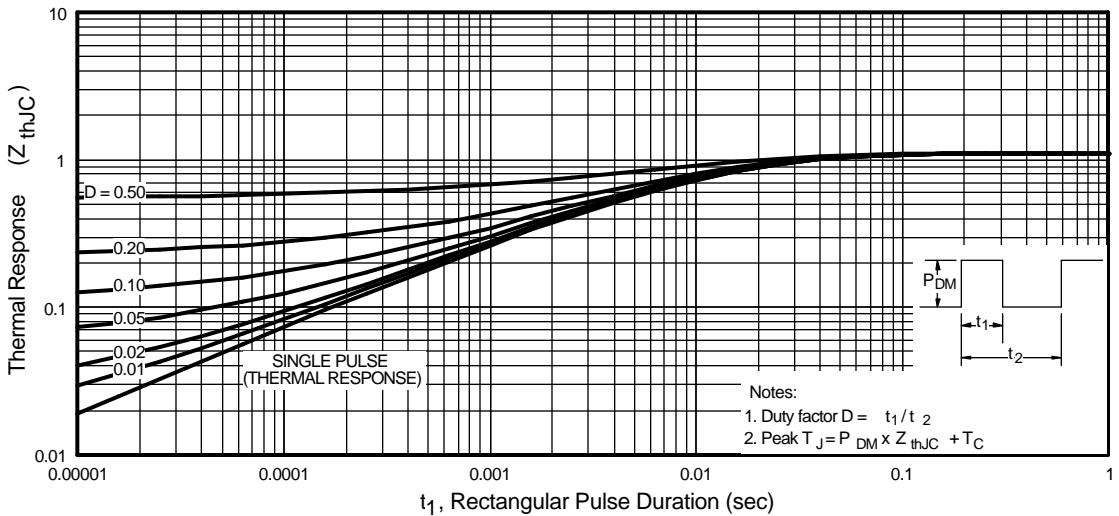

Fig 11. Maximum Effective Transient Thermal Impedance, Junction-to-Case

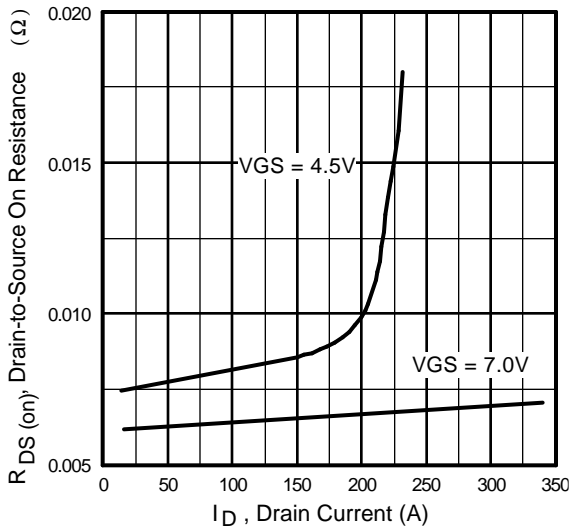

Fig 12. On-Resistance Vs. Drain Current

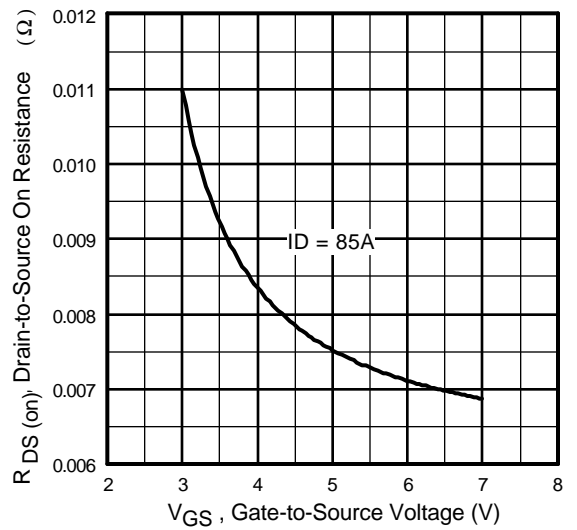
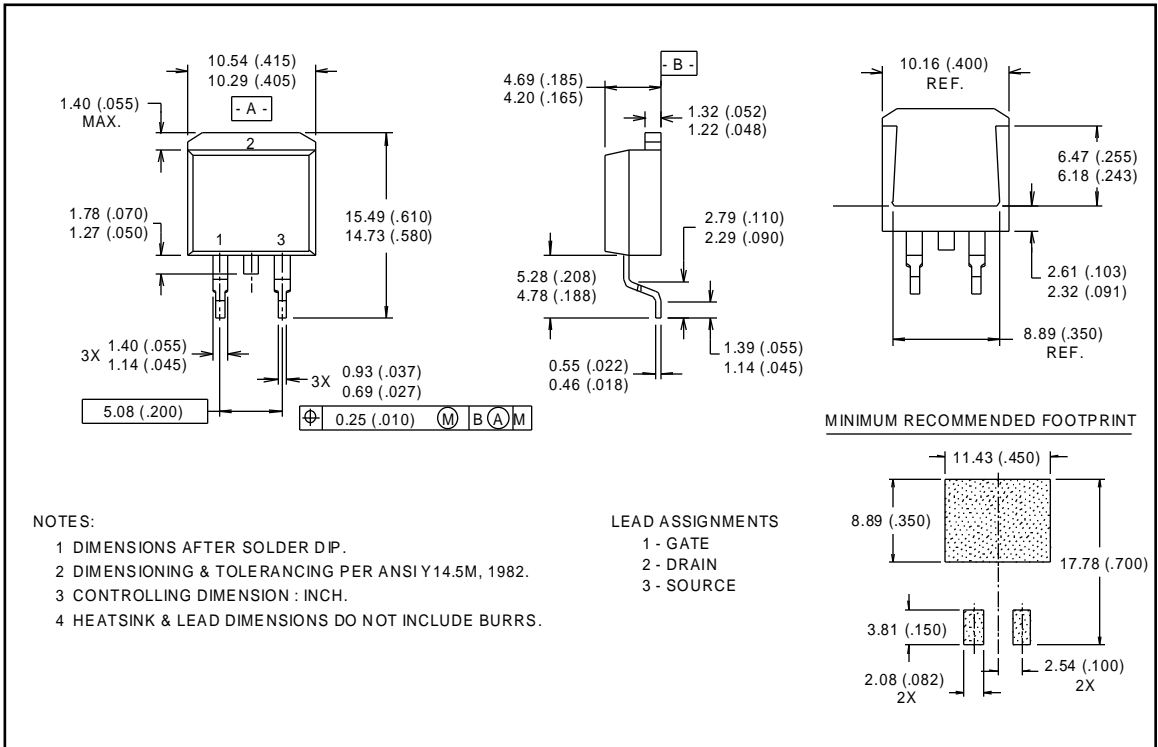

Fig 13. On-Resistance Vs. Gate Voltage

D²Pak Package Outline



Part Marking Information

D²Pak

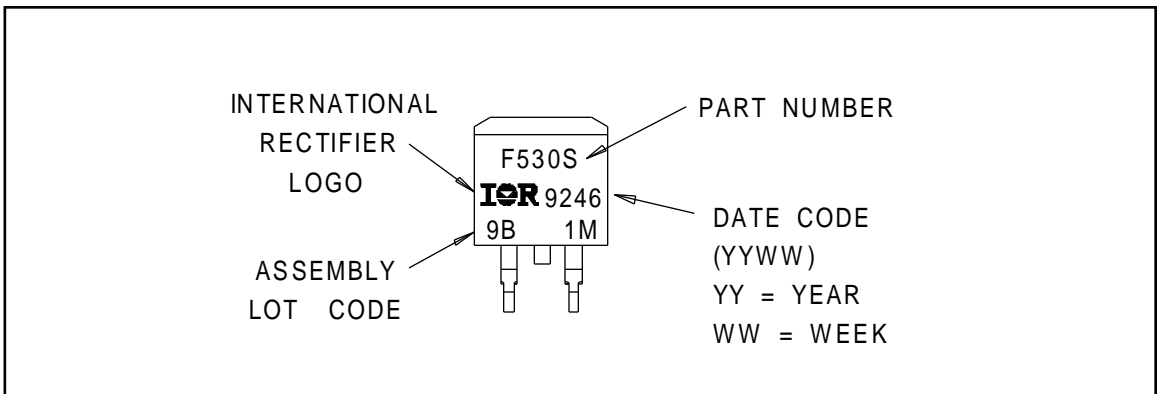

Tape & Reel Information

D²Pak

