

International
IR Rectifier

PD-94152

AUTOMOTIVE MOSFET

IRLL024NQ

HEXFET® Power MOSFET

Typical Applications

- Electronic Fuel Injection
- Active Suspension
- Power Doors, Windows & Seats
- Cruise Control
- Air Bags

Benefits

- Advanced Process Technology
- Ultra Low On-Resistance
- 175°C Operating Temperature
- Repetitive Avalanche Allowed up to Tjmax
- Dynamic dv/dt Rating
- Automotive [Q101] Qualified

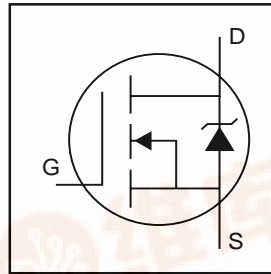

$V_{DSS} = 55V$
$R_{DS(on)} = 0.065\Omega$
$I_D = 3.1A$

Description

Specifically designed for Automotive applications, this HEXFET® Power MOSFET in a SOT-223 package utilizes the latest processing techniques to achieve extremely low on-resistance per silicon area. Additional features of this Automotive qualified HEXFET Power MOSFET are a 175°C junction operating temperature, fast switching speed and improved repetitive avalanche rating. These benefits combine to make this design an extremely efficient and reliable device for use in Automotive applications and a wide variety of other applications.



The efficient SOT-223 package is designed for surface mount and the enlarged tab provides improved thermal characteristics making it ideal in a variety of power applications. Power dissipation of 1.0W is possible in a typical surface mount application. Available in Tape & Reel.

Absolute Maximum Ratings

	Parameter	Max.	Units
$I_D @ T_C = 25^\circ C$	Continuous Drain Current, $V_{GS} @ 4.5V$	3.1	A
$I_D @ T_C = 70^\circ C$	Continuous Drain Current, $V_{GS} @ 4.5V$	2.6	
I_{DM}	Pulsed Drain Current ①	12	
$P_D @ T_C = 25^\circ C$	Power Dissipation ③	1.3	W
	Linear Derating Factor	8.3	mW/°C
V_{GS}	Gate-to-Source Voltage	±16	V
E_{AS}	Single Pulse Avalanche Energy ④	87	mJ
I_{AR}	Avalanche Current ①	See Fig.16c, 16d, 19, 20	A
E_{AR}	Repetitive Avalanche Energy ⑥		mJ
dv/dt	Peak Diode Recovery dv/dt ⑤	9.9	V/ns
T_J, T_{STG}	Junction and Storage Temperature Range	-55 to + 175	°C

Thermal Resistance

	Parameter	Typ.	Max.	Units
$R_{\theta JA}$	Junction-to-Amb. (PCB Mount, steady state)*	90	120	°C/W
$R_{\theta JA}$	Junction-to-Amb. (PCB Mount, steady state)**	50	60	

* When mounted on FR-4 board using minimum recommended footprint.

** When mounted on 1 inch square copper board, for comparison with other SMD devices.



Electrical Characteristics @ $T_J = 25^\circ\text{C}$ (unless otherwise specified)

	Parameter	Min.	Typ.	Max.	Units	Conditions
$V_{(BR)DSS}$	Drain-to-Source Breakdown Voltage	55	—	—	V	$V_{GS} = 0V, I_D = 250\mu A$
$\Delta V_{(BR)DSS}/\Delta T_J$	Breakdown Voltage Temp. Coefficient	—	0.057	—	V/ $^\circ\text{C}$	Reference to $25^\circ\text{C}, I_D = 1\text{mA}$
$R_{DS(on)}$	Static Drain-to-Source On-Resistance	—	—	0.065	m Ω	$V_{GS} = 10V, I_D = 3.1A$ ②
		—	—	0.080		$V_{GS} = 5.0V, I_D = 2.5A$ ②
$V_{GS(th)}$	Gate Threshold Voltage	1.0	—	2.0	V	$V_{DS} = V_{GS}, I_D = 250\mu A$
g_{fs}	Forward Transconductance	4.5	—	—	S	$V_{DS} = 25V, I_D = 1.9A$
I_{DSS}	Drain-to-Source Leakage Current	—	—	25	μA	$V_{DS} = 55V, V_{GS} = 0V$
		—	—	250		$V_{DS} = 44V, V_{GS} = 0V, T_J = 125^\circ\text{C}$
I_{GSS}	Gate-to-Source Forward Leakage	—	—	100	nA	$V_{GS} = 16V$
	Gate-to-Source Reverse Leakage	—	—	-100		$V_{GS} = -16V$
Q_g	Total Gate Charge	—	11	17	nC	$I_D = 1.9A$
Q_{gs}	Gate-to-Source Charge	—	1.9	—		$V_{DS} = 44V$
Q_{gd}	Gate-to-Drain ("Miller") Charge	—	4.3	—		$V_{GS} = 10V$
$t_{d(on)}$	Turn-On Delay Time	—	12	—	ns	$V_{DD} = 28V$ ②
t_r	Rise Time	—	41	—		$I_D = 1.9A$
$t_{d(off)}$	Turn-Off Delay Time	—	48	—		$R_G = 24\Omega$
t_f	Fall Time	—	39	—		$R_D = 15\Omega$
C_{iss}	Input Capacitance	—	508	—	pF	$V_{GS} = 0V$
C_{oss}	Output Capacitance	—	141	—		$V_{DS} = 25V$
C_{rss}	Reverse Transfer Capacitance	—	62	—		$f = 1.0\text{MHz}$

Source-Drain Ratings and Characteristics

	Parameter	Min.	Typ.	Max.	Units	Conditions
I_S	Continuous Source Current (Body Diode)	—	—	3.1	A	MOSFET symbol showing the integral reverse p-n junction diode.
I_{SM}	Pulsed Source Current (Body Diode) ①	—	—	12		
V_{SD}	Diode Forward Voltage	—	—	1.0	V	$T_J = 25^\circ\text{C}, I_S = 1.9A, V_{GS} = 0V$ ②
t_{rr}	Reverse Recovery Time	—	40	60	ns	$T_J = 25^\circ\text{C}, I_F = 1.9A$
Q_{rr}	Reverse Recovery Charge	—	65	97	nC	$di/dt = 100A/\mu s$ ②

Notes:

- ① Repetitive rating; pulse width limited by max. junction temperature.
- ② Pulse width $\leq 400\mu s$; duty cycle $\leq 2\%$.
- ③ Surface mounted on 1 in square Cu board
- ④ Starting $T_J = 25^\circ\text{C}, L = 18\text{mH}$
 $R_G = 25\Omega, I_{AS} = 3.1A$. (See Figure 12).
- ⑤ $I_{SD} \leq 1.9A, di/dt \leq 197A/\mu s, V_{DD} \leq V_{(BR)DSS}, T_J \leq 175^\circ\text{C}$
- ⑥ Limited by T_{Jmax} , see Fig.16c, 16d, 19, 20 for typical repetitive avalanche performance.

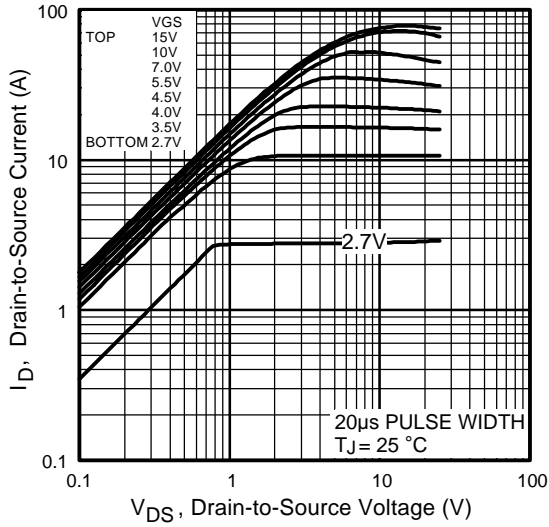

Fig 1. Typical Output Characteristics

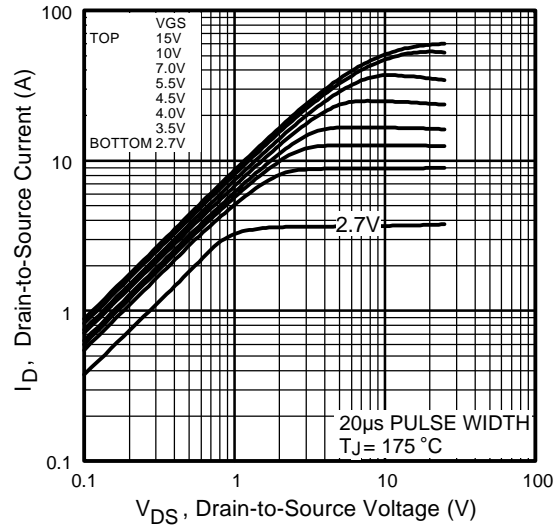

Fig 2. Typical Output Characteristics

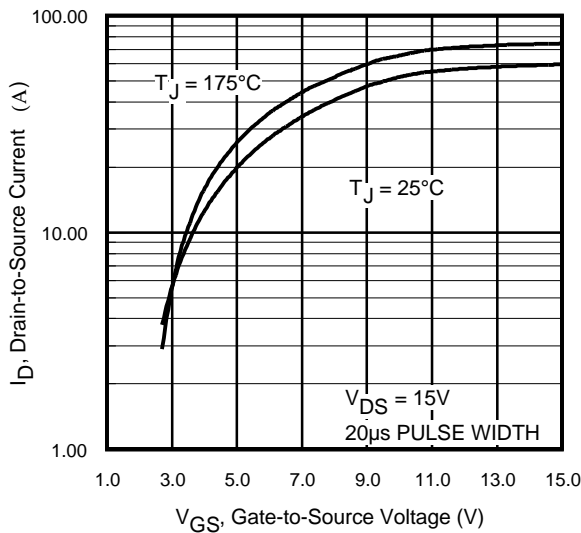

Fig 3. Typical Transfer Characteristics

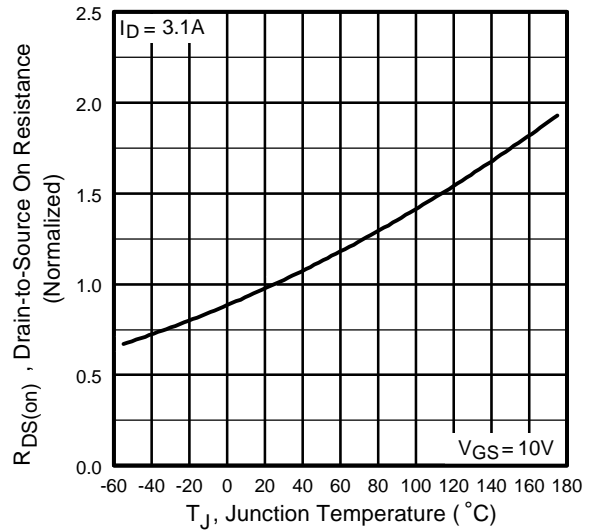

Fig 4. Normalized On-Resistance Vs. Temperature

IRLL024NQ

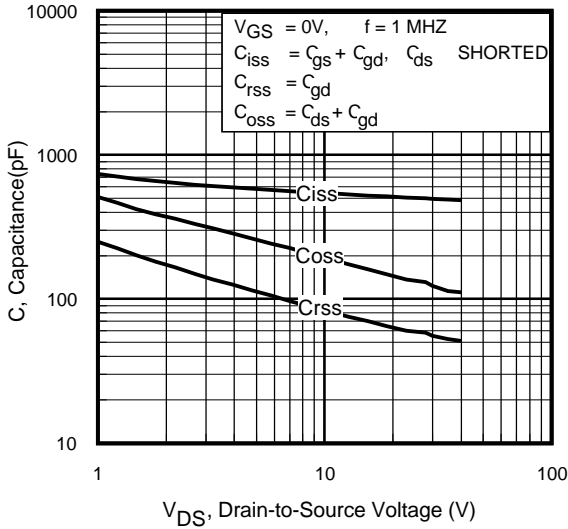

Fig 5. Typical Capacitance Vs. Drain-to-Source Voltage

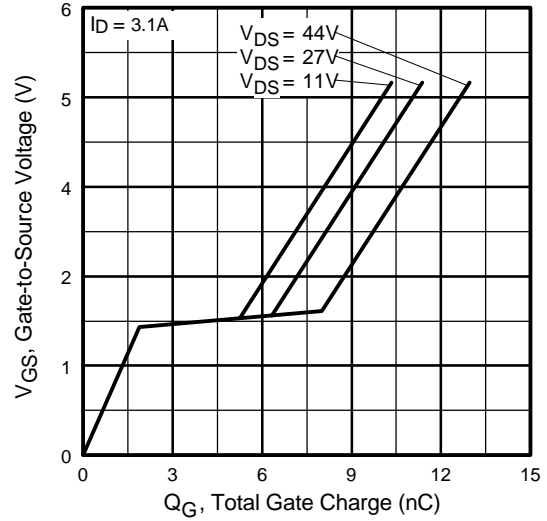

Fig 6. Typical Gate Charge Vs. Gate-to-Source Voltage

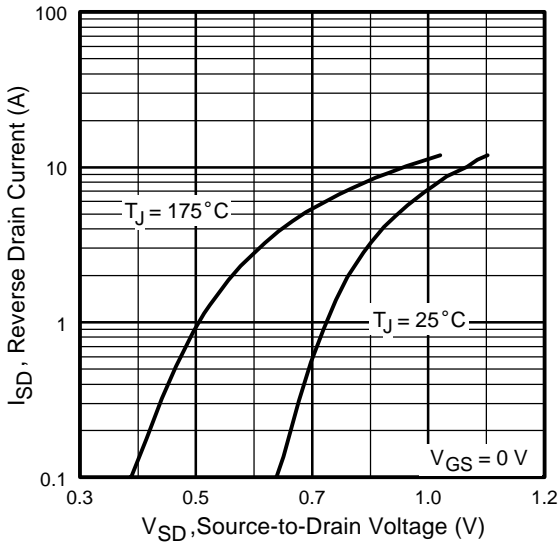

Fig 7. Typical Source-Drain Diode Forward Voltage

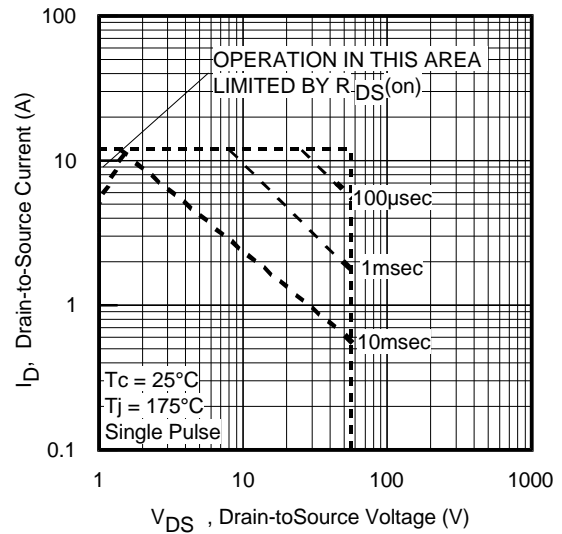

Fig 8. Maximum Safe Operating Area

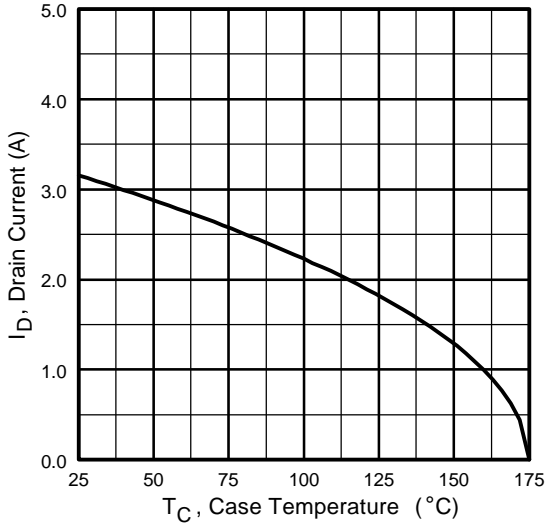

Fig 9. Maximum Drain Current Vs. Case Temperature

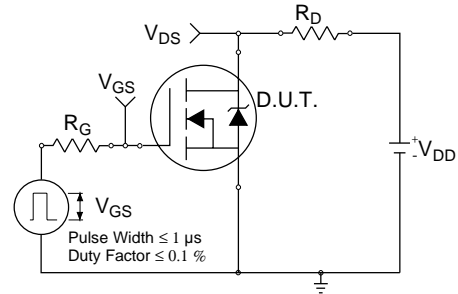

Fig 10a. Switching Time Test Circuit

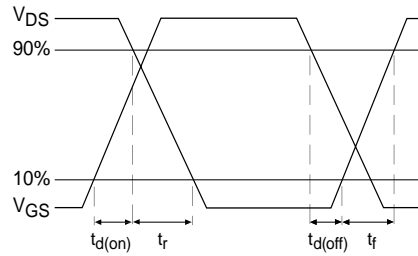

Fig 10b. Switching Time Waveforms

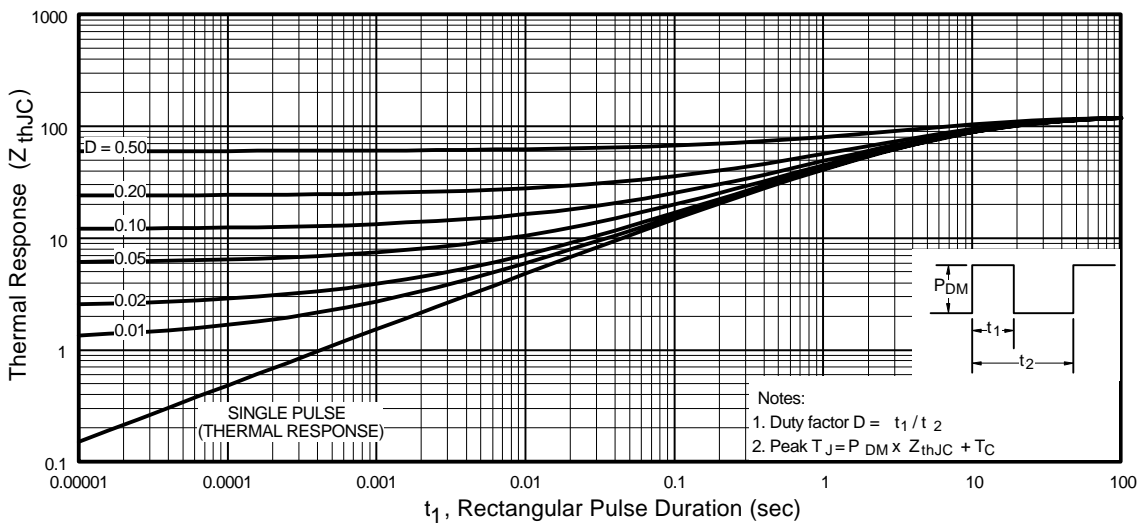

Fig 11. Typical Effective Transient Thermal Impedance, Junction-to-Ambient

IRLL024NQ

International
IR Rectifier

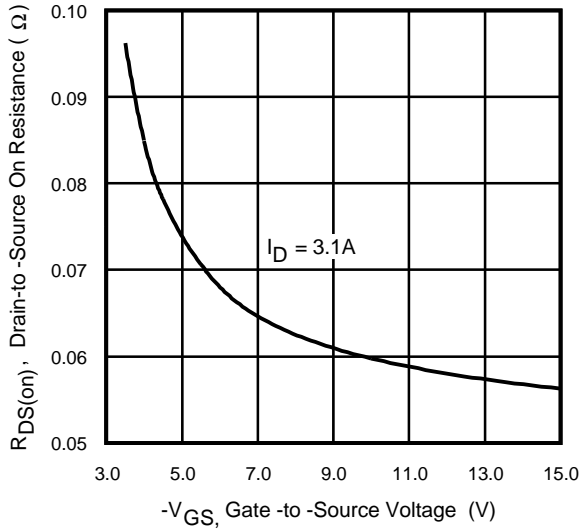

Fig 12. Typical On-Resistance Vs. Gate Voltage

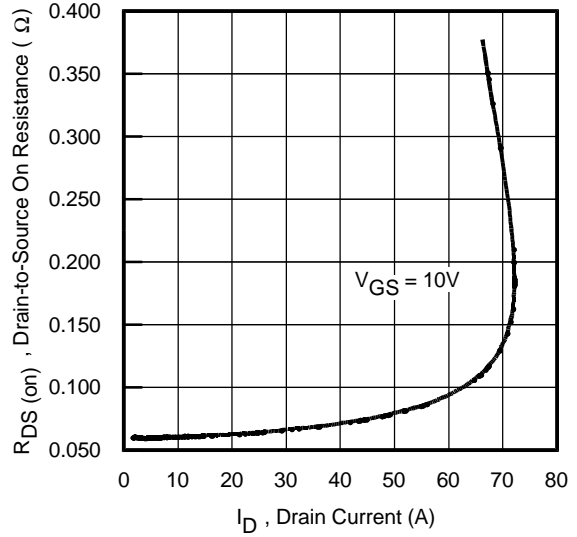

Fig 13. Typical On-Resistance Vs. Drain Current

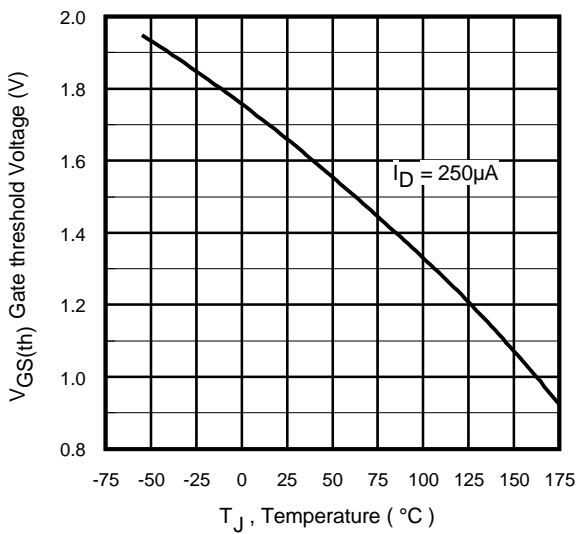

Fig 14. Typical Threshold Voltage Vs. Junction Temperature

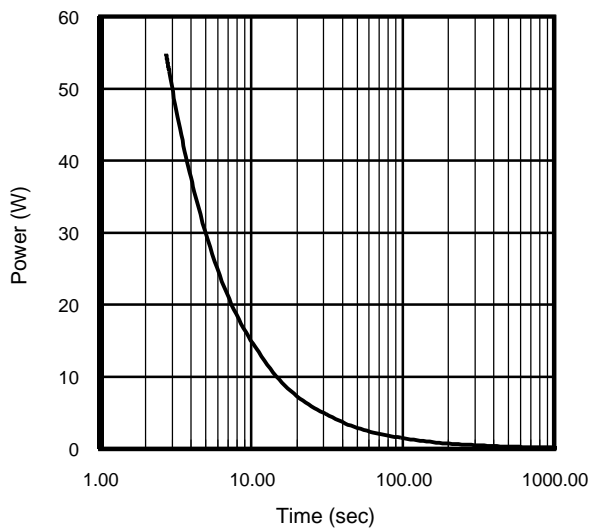

Fig 15. Typical Power Vs. Time

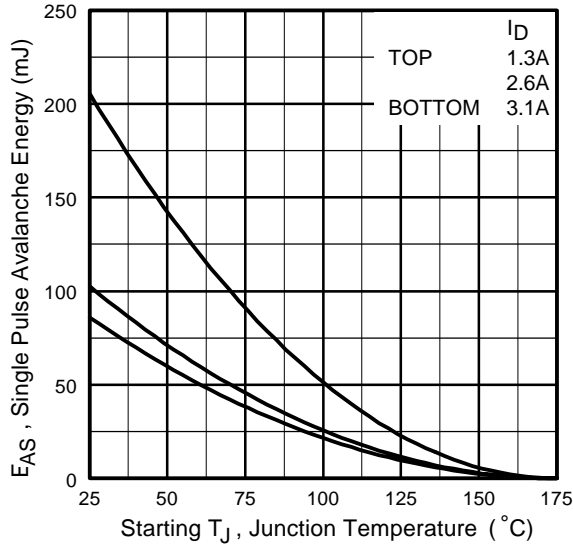

Fig 16a. Maximum Avalanche Energy Vs. Drain Current

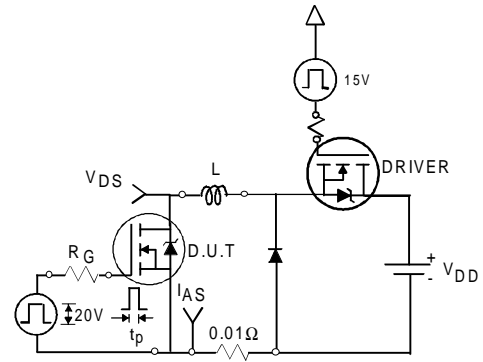

Fig 16c. Unclamped Inductive Test Circuit

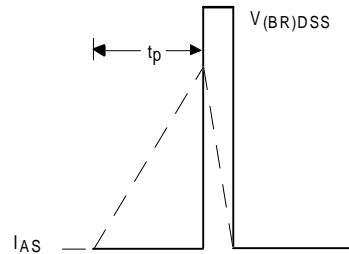

Fig 16d. Unclamped Inductive Waveforms

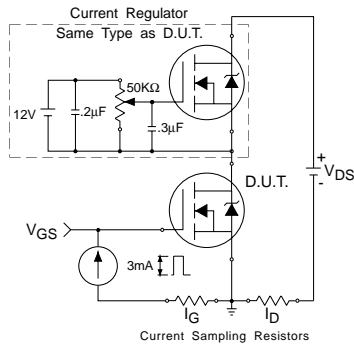

Fig 17. Gate Charge Test Circuit

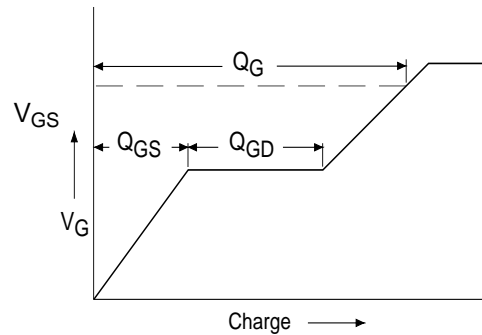

Fig 18. Basic Gate Charge Waveform

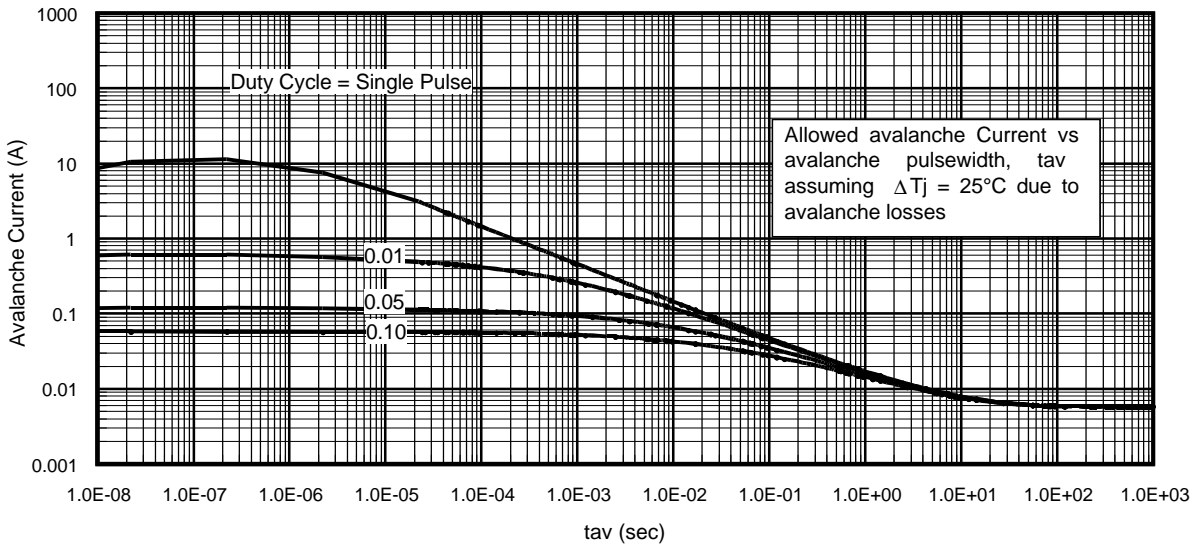

Fig 19. Typical Avalanche Current Vs.Pulsewidth

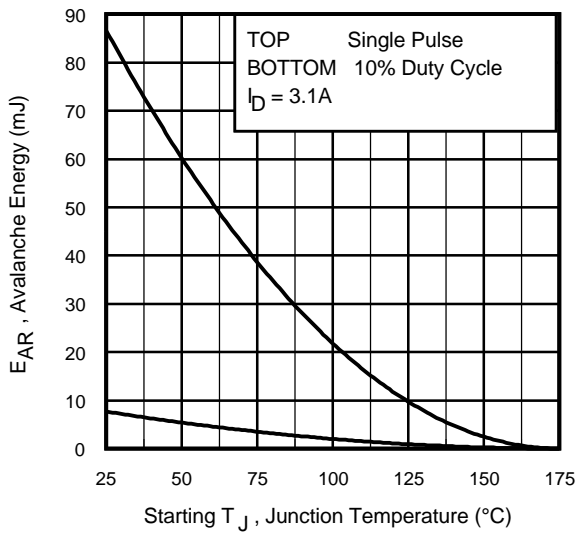

Fig 20. Maximum Avalanche Energy Vs. Temperature

Notes on Repetitive Avalanche Curves , Figures 15, 16:
(For further info, see AN-1005 at www.irf.com)

1. Avalanche failures assumption:
Purely a thermal phenomenon and failure occurs at a temperature far in excess of T_{jmax} . This is validated for every part type.
2. Safe operation in Avalanche is allowed as long as T_{jmax} is not exceeded.
3. Equation below based on circuit and waveforms shown in Figures 12a, 12b.
4. $P_{D(ave)}$ = Average power dissipation per single avalanche pulse.
5. BV = Rated breakdown voltage (1.3 factor accounts for voltage increase during avalanche).
6. I_{av} = Allowable avalanche current.
7. ΔT = Allowable rise in junction temperature, not to exceed T_{jmax} (assumed as 25°C in Figure 15, 16).
 t_{av} = Average time in avalanche.
 D = Duty cycle in avalanche = $t_{av} \cdot f$
 $Z_{thJC}(D, t_{av})$ = Transient thermal resistance, see figure 11)

$$P_{D(ave)} = 1/2 (1.3 \cdot BV \cdot I_{av}) = \Delta T / Z_{thJC}$$

$$I_{av} = 2\Delta T / [1.3 \cdot BV \cdot Z_{th}]$$

$$E_{AS(AR)} = P_{D(ave)} \cdot t_{av}$$

Package Outline
SOT-223

IRFLL024NQ

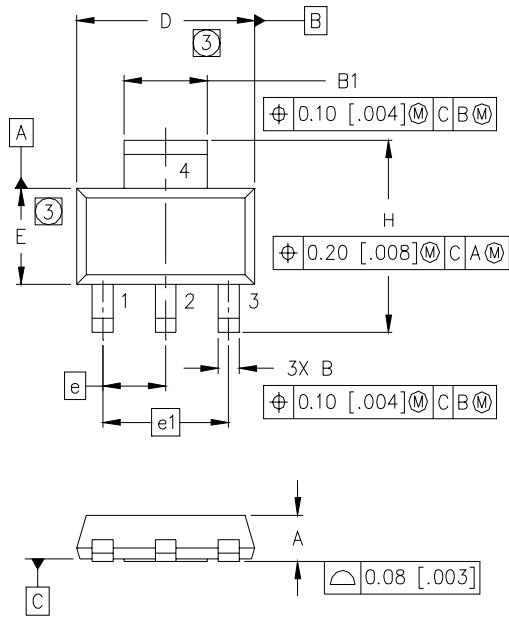

DIM	MILLIMETERS		INCHES	
	MIN	MAX	MIN	MAX
A	1.55	1.80	.061	.071
B	0.65	0.85	.026	.033
B1	2.95	3.15	.116	.124
C	0.25	0.35	.010	.014
D	6.30	6.70	.248	.264
E	3.30	3.70	.130	.146
e	2.30	BSC	.0905	BSC
e1	4.60	BSC	.181	BSC
H	6.71	7.29	.264	.287
L	0.91	—	.036	—
L1	0.061	BSC	.0024	BSC
θ	—	10°	—	10°

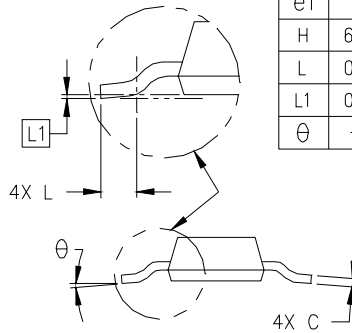

MINIMUM RECOMMENDED FOOTPRINT

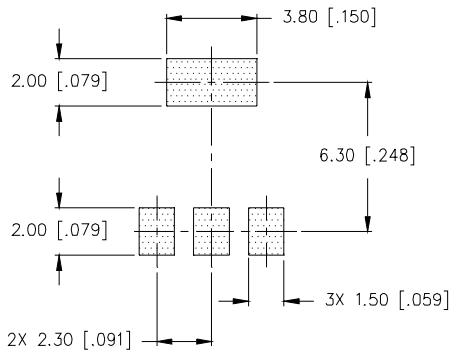

LEAD ASSIGNMENTS

- 1 = GATE
- 2 = DRAIN
- 3 = SOURCE
- 4 = DRAIN

NOTES:

1. DIMENSIONING & TOLERANCING PER ASME Y14.5M-1994.
2. CONTROLLING DIMENSION: INCH.
- ③ DIMENSIONS DO NOT INCLUDE MOLD FLASH.
4. OUTLINE CONFORMS TO JEDEC OUTLINE TO-261AA.
5. DIMENSIONS ARE SHOWN IN MILLIMETERS [INCHES].

Part Marking Information

SOT-223

EXAMPLE : THIS IS AN IRFL014

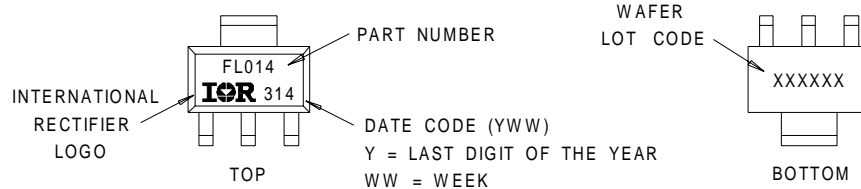

IRLL024NQ

International
IR Rectifier

Tape & Reel Information

SOT-223

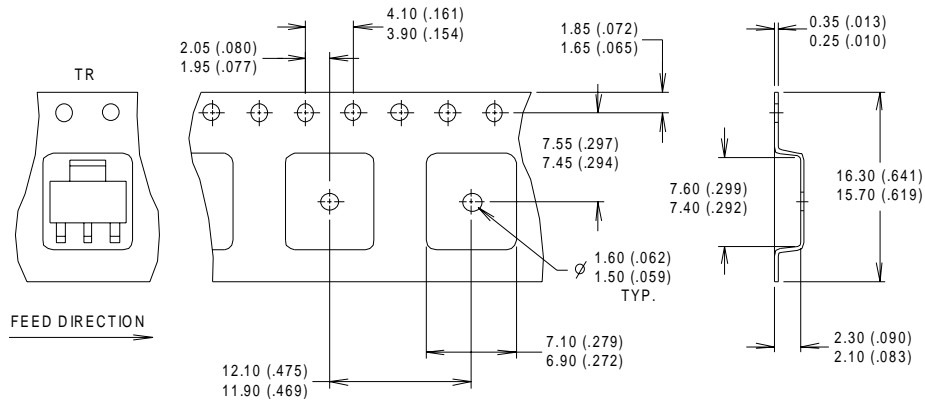

- NOTES :
1. CONTROLLING DIMENSION: MILLIMETER.
 2. OUTLINE CONFORMS TO EIA-481 & EIA-541.
 3. EACH $\varnothing 330.00$ (13.00) REEL CONTAINS 2,500 DEVICES.

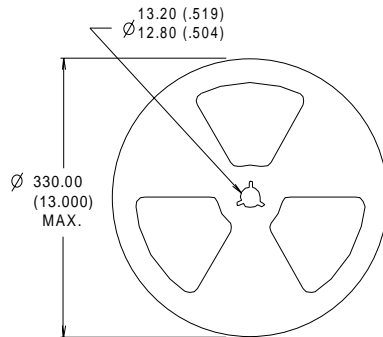

- NOTES :
1. OUTLINE CONFORMS TO EIA-418-1.
 2. CONTROLLING DIMENSION: MILLIMETER..
 - ③ DIMENSION MEASURED @ HUB.
 - ④ INCLUDES FLANGE DISTORTION @ OUTER EDGE.

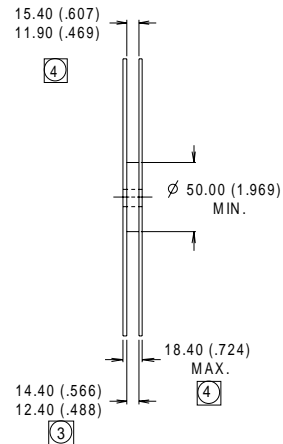

Data and specifications subject to change without notice.
This product has been designed and qualified for the Automotive [Q101] market.
Qualification Standards can be found on IR's Web site.

International
IR Rectifier

IR WORLD HEADQUARTERS: 233 Kansas St., El Segundo, California 90245, USA Tel: (310) 252-7105
TAC Fax: (310) 252-7903

Visit us at www.irf.com for sales contact information. 3/01

www.irf.com