

Bulletin PD-20591 rev.A 02/02

International
IR Rectifier

MBRS140TR

SCHOTTKY RECTIFIER

1 Amp

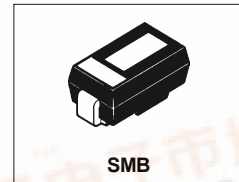

Major Ratings and Characteristics

Characteristics	MBRS140TR	Units
$I_{F(AV)}$ Rectangular waveform	1.0	A
V_{RRM}	40	V
I_{FSM} @ $t_p = 5 \mu s$ sine	380	A
V_F @ 1.0Apk, $T_J = 125^\circ C$	0.53	V
T_J range	-55 to 150	$^\circ C$

Description/Features

The MBRS140TR surface-mount Schottky rectifier has been designed for applications requiring low forward drop and very small foot prints on PC boards. Typical applications are in disk drives, switching power supplies, converters, free-wheeling diodes, battery charging, and reverse battery protection.

- Small foot print, surface mountable
- Low forward voltage drop
- High frequency operation
- Guard ring for enhanced ruggedness and long term reliability

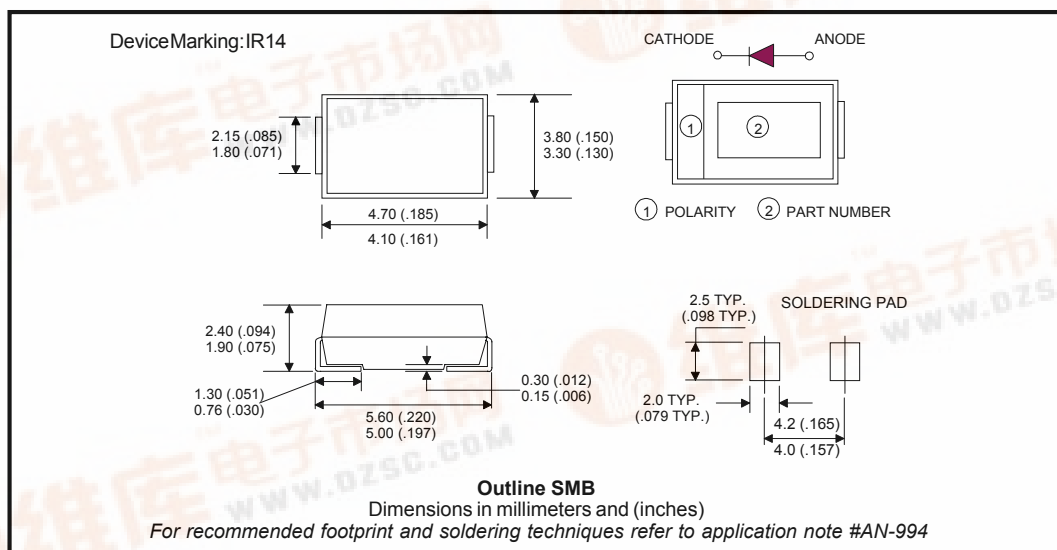

MBRS140TR

Bulletin PD-20591 rev. A 02/02



Voltage Ratings

Partnumber	MBRS140TR
V _R Max. DC Reverse Voltage (V)	40
V _{RWM} Max. Working Peak Reverse Voltage (V)	

Absolute Maximum Ratings

Parameters	Value	Units	Conditions
I _{F(AV)} Max. Average Forward Current	1.0	A	50% duty cycle @ T _L = 119°C, rectangular waveform
I _{FSM} Max. Peak One Cycle Non-Repetitive Surge Current	380	A	Following any rated load condition and with rated V _{RRM} applied
	40		
E _{AS} Non-Repetitive Avalanche Energy	4	mJ	T _J = 25°C, I _{AS} = 1.0A, L = 5.0mH
I _{AR} Repetitive Avalanche Current	0.6	A	Current decaying linearly to zero in 1µsec Frequency limited by T _J max. Va = 1.5 x Vr typical

Electrical Specifications

Parameters	Typ.	Max	Units	Conditions
V _{FM} Max. Forward Voltage Drop (1)	0.52	0.6	V	@ 1A
	0.70	0.77	V	@ 2A
	0.48	0.53	V	@ 1A
	0.63	0.71	V	@ 2A
I _{RM} Max. Reverse Leakage Current (1)	-	0.1	mA	T _J = 25°C
	-	4.0	mA	T _J = 125°C
				V _R = rated V _R
C _T Max. Junction Capacitance	-	80	pF	V _R = 5V _{DC} (test signal range 100KHz to 1Mhz) 25°C
L _S Typical Series Inductance	-	2.0	nH	Measured lead to lead 5mm from package body
dv/dt Max. Voltage Rate of Change (Rated V _R)	-	10000	V/µs	

(1) Pulse Width < 300µs, Duty Cycle < 2%

Thermal-Mechanical Specifications

Parameters	Value	Units	Conditions
T _J Max. Junction Temperature Range (*)	-55 to 150	°C	
T _{stg} Max. Storage Temperature Range	-55 to 150	°C	
R _{thJL} Max. Thermal Resistance Junction to Lead (**)	36	°C/W	DC Operation (See Fig. 4)
R _{thJA} Max. Thermal Resistance Junction to Ambient	80	°C/W	DC Operation
wt Approximate Weight	0.10(0.003)	g(oz.)	
Case Style	SMB		Similar to DO-214AA
Device Marking	IR14		

(*) $\frac{dP_{tot}}{dT_J} < \frac{1}{R_{th(j-a)}}$ thermal runaway condition for a diode on its own heatsink

(**) Mounted 1 inch square PCB

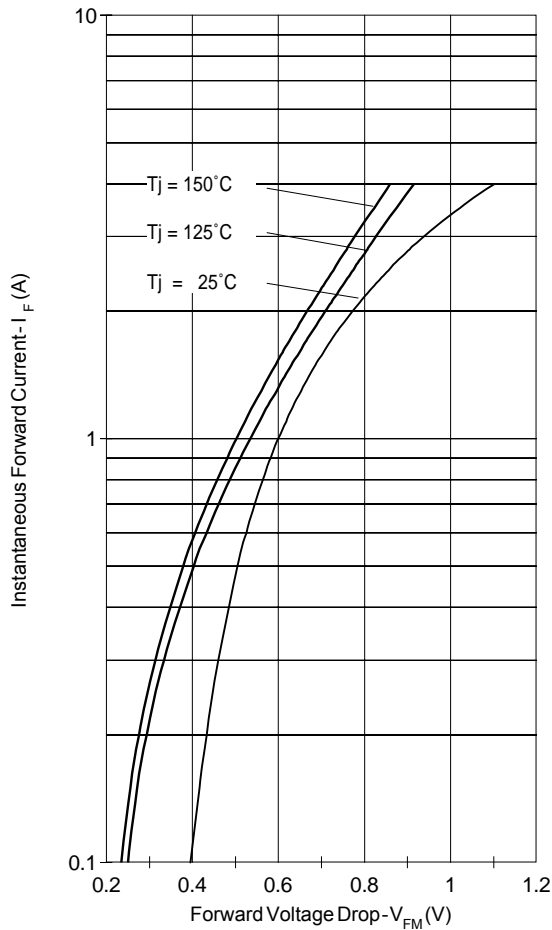

Fig. 1 - Maximum Forward Voltage Drop Characteristics

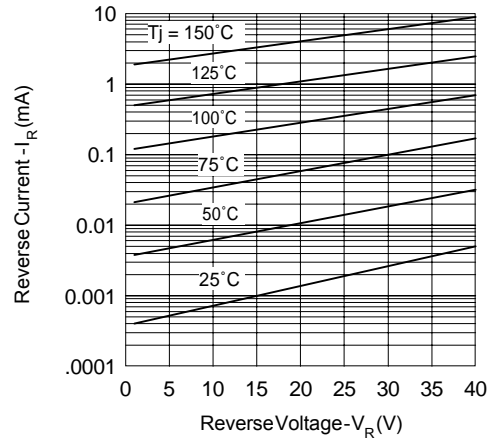

Fig. 2 - Typical Peak Reverse Current Vs. Reverse Voltage

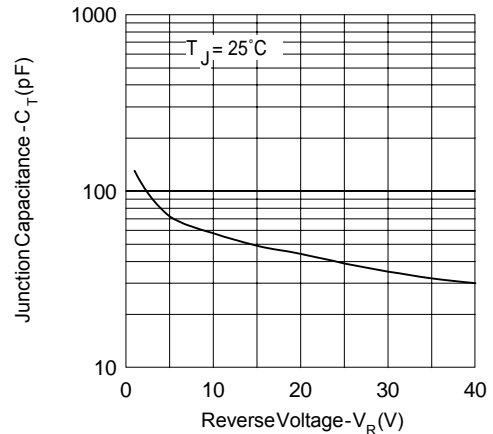

Fig. 3 - Typical Junction Capacitance Vs. Reverse Voltage

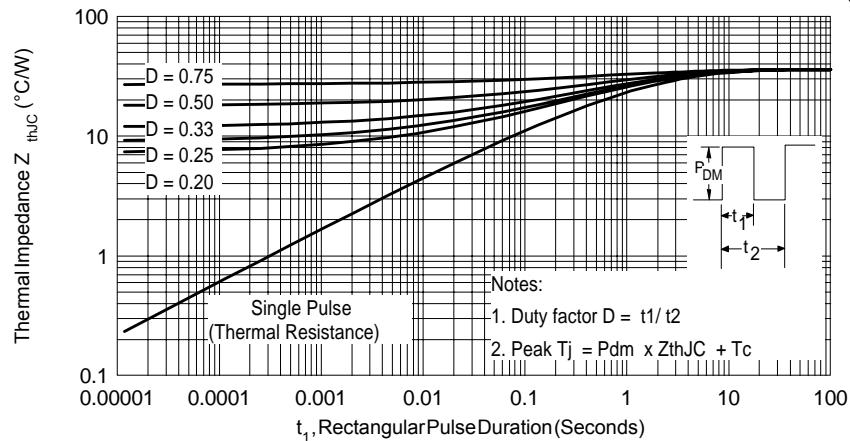

Fig. 4 - Max. Thermal Impedance Z_{thJC} Characteristics (Per Leg)

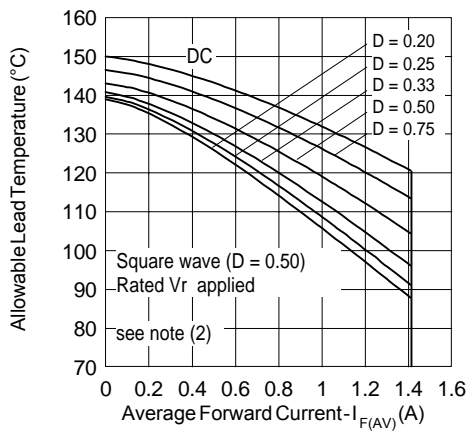

Fig. 4- Maximum Average Forward Current Vs. Allowable Lead Temperature

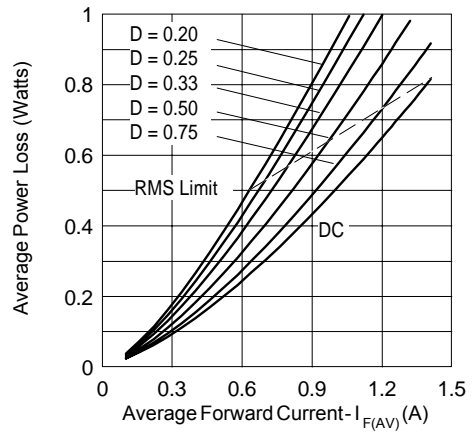

Fig. 5- Maximum Average Forward Dissipation Vs. Average Forward Current

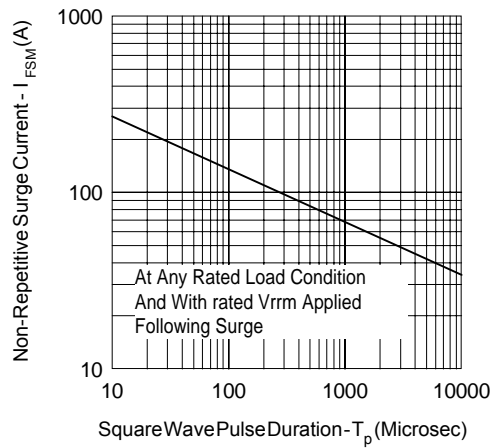
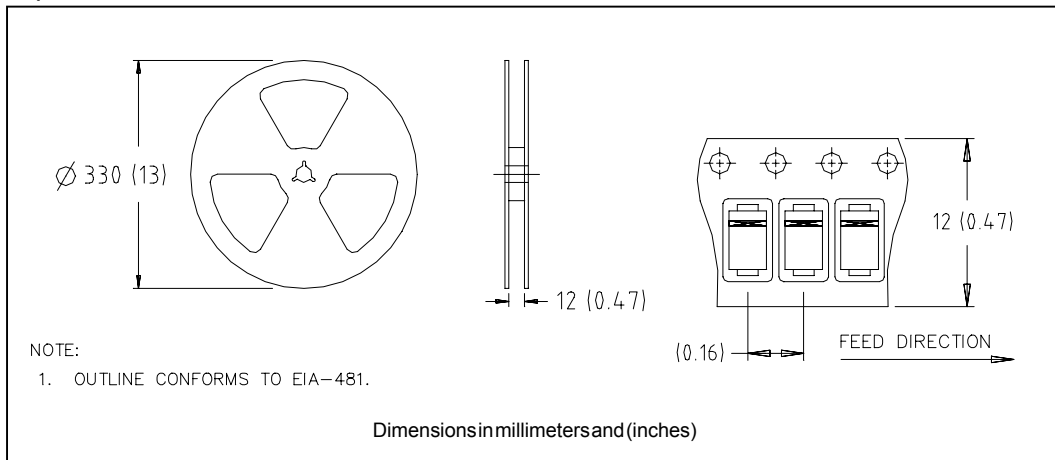

Fig. 6- Maximum Peak Surge Forward Current Vs. Pulse Duration

- (2) Formula used: $T_c = T_j - (Pd + Pd_{REV}) \times R_{thJC}$;
 $Pd = \text{Forward Power Loss} = I_{F(AV)} \times V_{FM} @ (I_{F(AV)} / D)$ (see Fig. 6);
 $Pd_{REV} = \text{Inverse Power Loss} = V_{R1} \times I_R (1 - D); I_R @ V_{R1} = 80\% \text{ rated } V_R$

Tape & Reel Information



Marking & Identification

Each device has marking and identification on two rows.
 - The first row designates the device as manufactured by International Rectifier as indicated by the letters "IR", then Current and Voltage.
 - The second row shows the data code: Year and Week.

See below marking diagram.

FIRST ROW

IR 14

SECOND ROW

Date Code

YY WW

Ordering Information

MBRS140TR - TAPE AND REEL

WHEN ORDERING, INDICATE THE PART NUMBER AND THE QUANTITY (IN MULTIPLES OF 3000 PIECES).

EXAMPLE: MBRS140TR - 6000 PIECES

MBRS140TR

Bulletin PD-20591 rev. A 02/02

International
IOR Rectifier

Data and specifications subject to change without notice.
This product has been designed and qualified for Industrial Level.
Qualification Standards can be found on IR's Web site.

International
IOR Rectifier

IR WORLD HEADQUARTERS: 233 Kansas St., El Segundo, California 90245, USA Tel: (310) 252-7105
TAC Fax: (310) 252-7309
Visit us at www.irf.com for sales contact information. 02/02