

Bulletin PD-20586 rev. A 02/02

International IOR Rectifier

MBRS360TR

SCHOTTKY RECTIFIER

3 Amp



Major Ratings and Characteristics

Characteristics	MBRS360TR	Units
$I_{F(AV)}$ Rectangular waveform	3.0	A
V_{RRM}	60	V
I_{FSM} @ $t_p=5\mu s$ sine	790	A
V_F @ $3.0A_{pk}, T_J=125^\circ C$	0.61	V
T_J range	- 55 to 150	$^\circ C$

Description/Features

The MBRS360TR surface-mount Schottky rectifier has been designed for applications requiring low forward drop and small foot prints on PC boards. Typical applications are in disk drives, switching power supplies, converters, free-wheeling diodes, battery charging, and reverse battery protection.

- Small foot print, surface mountable
- Very low forward voltage drop
- High frequency operation
- Guard ring for enhanced ruggedness and long term reliability

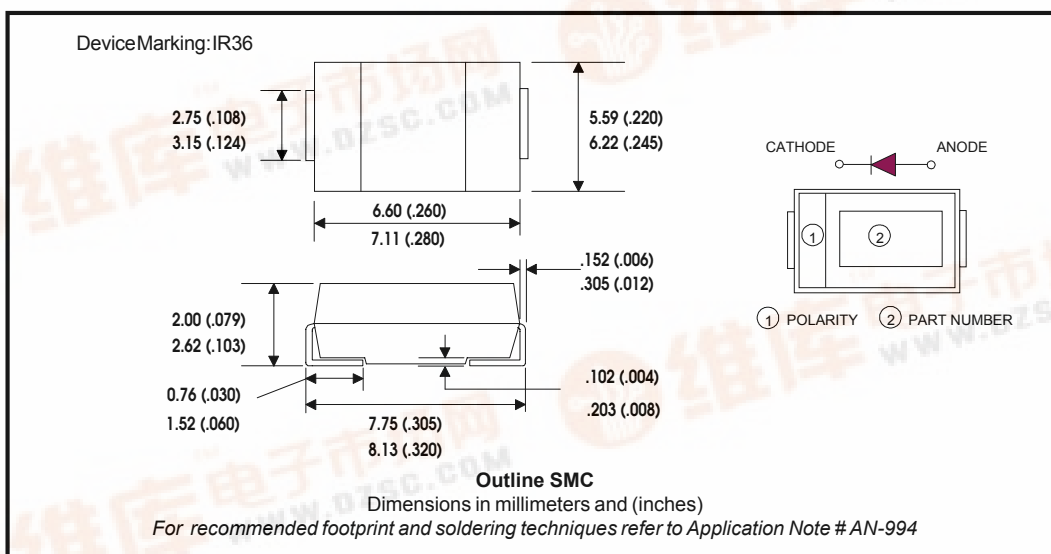

Voltage Ratings

Part number	MBRS360TR
V _R Max. DC Reverse Voltage (V)	60
V _{RWM} Max. Working Peak Reverse Voltage (V)	

Absolute Maximum Ratings

Parameters	Value	Units	Conditions
I _{F(AV)} Max. Average Forward Current	3.0	A	50% duty cycle @ T _L = 118 °C, rectangular waveform
	4.0		50% duty cycle @ T _L = 105 °C, rectangular waveform
I _{FSM} Max. Peak One Cycle Non-Repetitive Surge Current	790	A	5µs Sine or 3µs Rect. pulse
	80		10ms Sine or 6ms Rect. pulse
E _{AS} Non Repetitive Avalanche Energy	6	mJ	T _J = 25 °C, I _{AS} = 2.0A, L = 10mH
I _{AR} Repetitive Avalanche Current	0.6	A	Current decaying linearly to zero in 1µsec Frequency limited by T _J max. Va = 1.5 x Vr typical

Electrical Specifications

Parameters	Typ	Max	Units	Conditions
V _{FM} Max. Forward Voltage Drop (1)	0.57	0.74	V	@ 3A
	0.72	0.9	V	@ 6A
	0.51	0.61	V	@ 3A
	0.62	0.77	V	@ 6A
I _{RM} Max. Reverse Leakage Current (1)	-	0.5	mA	T _J = 25 °C
	-	20	mA	T _J = 100 °C
	-	30	mA	T _J = 125 °C
C _T Max. Junction Capacitance	-	180	pF	V _R = 5V _{DC} (test signal range 100KHz to 1Mhz) 25 °C
L _S Typical Series Inductance	-	3.0	nH	Measured lead to lead 5mm from package body
dv/dt Max. Voltage Rate of Change	-	10000	V/µs	(Rated V _R)

(1) Pulse Width < 300µs, Duty Cycle < 2%

Thermal-Mechanical Specifications

Parameters	Value	Units	Conditions
T _J Max. Junction Temperature Range (*)	-55 to 150	°C	
T _{stg} Max. Storage Temperature Range	-55 to 150	°C	
R _{thJL} Max. Thermal Resistance Junction to Lead (**)	12	°C/W	DC operation
R _{thJA} Max. Thermal Resistance Junction to Ambient	46	°C/W	DC operation
wt Approximate Weight	0.24(0.008)	g(oz.)	
Case Style	SMC		Similar to DO-214AB
Device Marking	IR36		

(*) $\frac{dP_{tot}}{dT_J} < \frac{1}{R_{th(j-a)}}$ thermal runaway condition for a diode on its own heatsink

(**) Mounted 1 inch square PCB

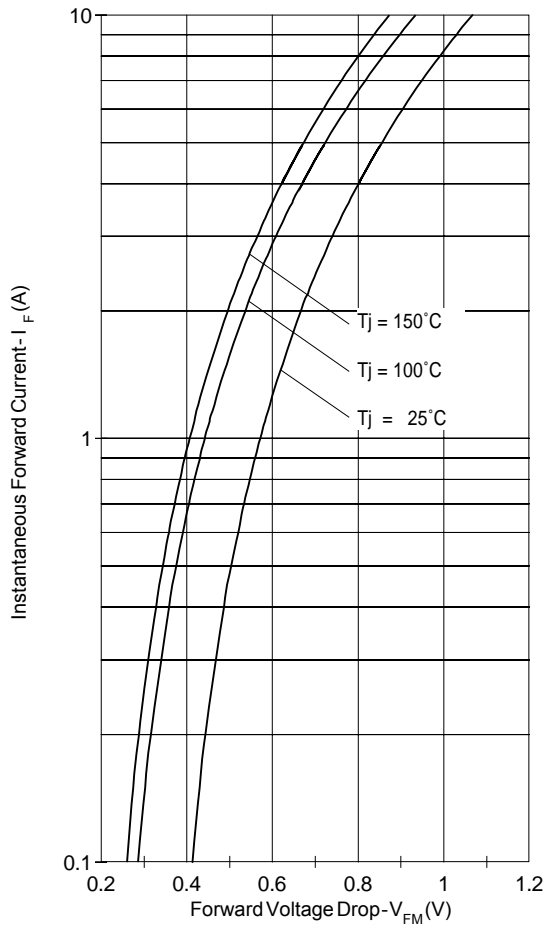

Fig. 1 - Max. Forward Voltage Drop Characteristics (PerLeg)

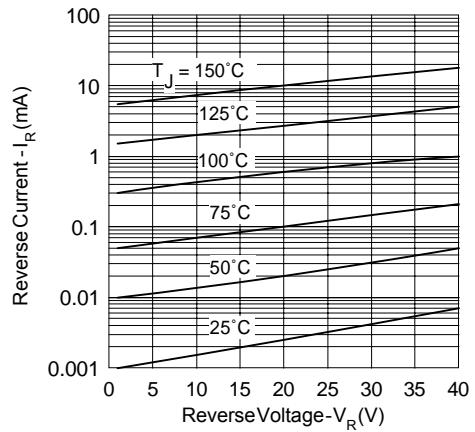

Fig. 2 - Typical Values Of Reverse Current Vs. Reverse Voltage (PerLeg)

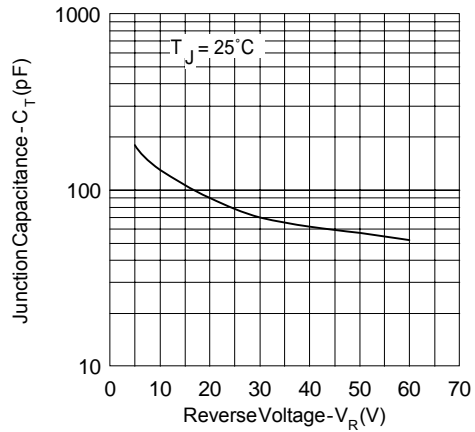

Fig. 3 - Typical Junction Capacitance Vs. Reverse Voltage (PerLeg)

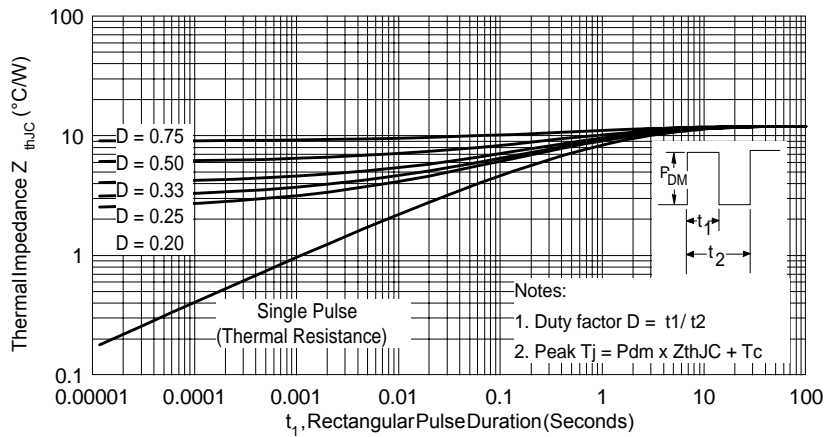

Fig. 4 - Max. Thermal Impedance Z_{thJC} Characteristics (PerLeg)

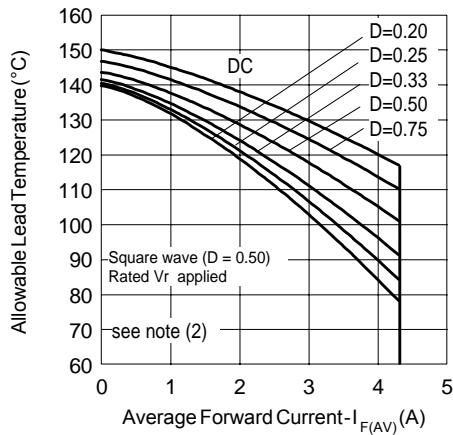

Fig.4- Maximum Average Forward Current Vs. Allowable Lead Temperature

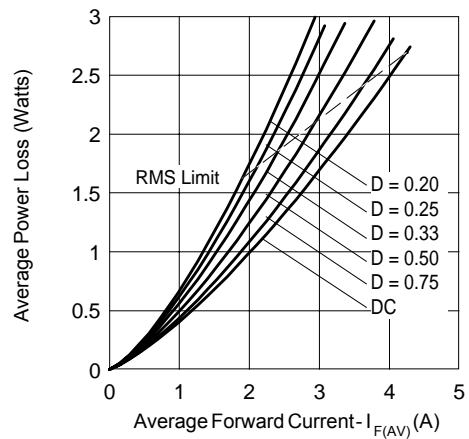

Fig.5- Maximum Average Forward Dissipation Vs. Average Forward Current

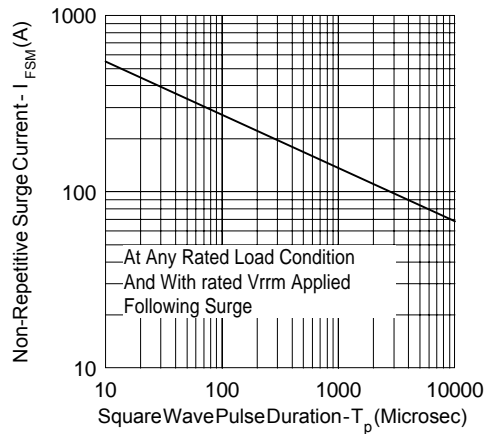
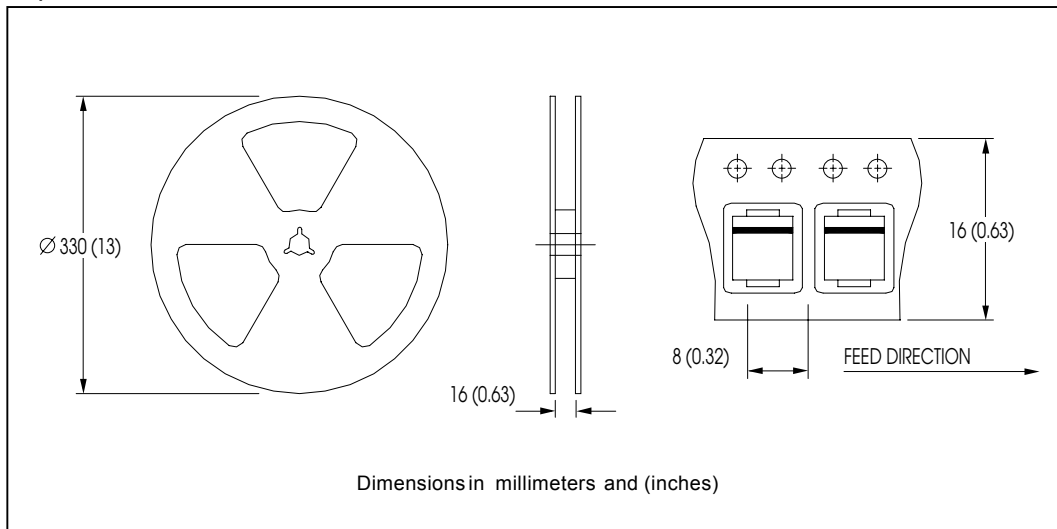

Fig. 6- Maximum Peak Surge Forward Current Vs. Pulse Duration

- (2) Formula used: $T_C = T_J - (Pd + Pd_{REV}) \times R_{thJC}$;
 $Pd = \text{Forward Power Loss} = I_{F(AV)} \times V_{FM} @ (I_{F(AV)} / D)$ (see Fig. 6);
 $Pd_{REV} = \text{Inverse Power Loss} = V_{R1} \times I_R (1 - D); I_R @ V_{R1} = 80\% \text{ rated } V_R$

Tape & Reel Information



Marking & Identification

Each device has marking and identification on two rows.
 - The first row designates the device as manufactured by International Rectifier as indicated by the letters "IR", then Current and Voltage.
 - The second row shows the data code: Year and Week.

See below marking diagram.

FIRST ROW

IR 36

SECOND ROW

Date Code

YY WW

Ordering Information

MBRS360TR - TAPE AND REEL

WHEN ORDERING, INDICATE THE PART NUMBER AND THE QUANTITY (IN MULTIPLES OF 3000 PIECES).

EXAMPLE: MBRS360TR - 6000 PIECES

MBRS360TR

Bulletin PD-20586 rev. A 02/02

International
IOR Rectifier

Data and specifications subject to change without notice.
This product has been designed and qualified for Industrial Level.
Qualification Standards can be found on IR's Web site.

International
IOR Rectifier

IR WORLD HEADQUARTERS: 233 Kansas St., El Segundo, California 90245, USA Tel: (310) 252-7105
TAC Fax: (310) 252-7309
Visit us at www.irf.com for sales contact information. 02/02