

International IOR Rectifier

Data Sheet No. PD 10035C

Series PVG612

Microelectronic Power IC

HEXFET[®] Power MOSFET Photovoltaic Relay
Single Pole, Normally Open, 0-60V, 1.0A AC/ 2.0 A DC

General Description

The PVG612 Series Photovoltaic Relay is a single-pole, normally open solid-state relay that can replace electromechanical relays in many applications. It utilizes International Rectifier's proprietary HEXFET power MOSFET as the output switch, driven by an integrated circuit photovoltaic generator of novel construction. The output switch is controlled by radiation from a GaAlAs light emitting diode (LED) which is optically isolated from the photovoltaic generator.

These units exceed the performance capabilities of electromechanical relays in operating life, sensitivity, stability of on-resistance, miniaturization, insensitivity to magnetic fields and ruggedness. The compact PVG612 is particularly suited for isolated switching of high currents from 12 to 48 Volt AC or DC power sources.

Series PVG612 Relays are packaged in a 6-pin, molded DIP package with either through-hole or surface mount (gull-wing) terminals. It is available in standard plastic shipping tubes or on tape-and-reel. Please refer to Part Identification information opposite.

Applications

- Programmable Logic Controllers
- Computers and Peripheral Devices
- Audio Equipment
- Power Supplies and Power Distribution
- Control of Displays and Indicators
- Industrial Automation

Features

- Bounce-free operation
- High load current capacity
- High off-state resistance
- Linear AC/DC operation
- 4,000 V_{RMS} I/O Isolation
- Solid-State reliability
- UL recognized and CSA certified
- ESD Tolerance:
 - 4000V Human Body Model
 - 500V Machine Model

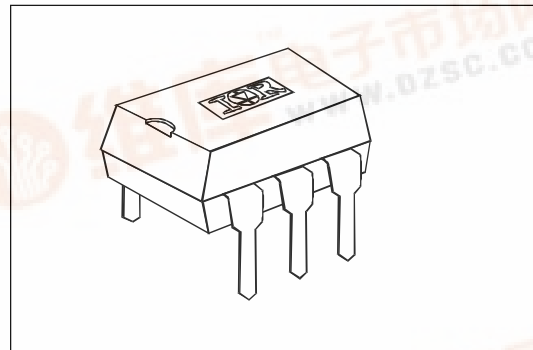

Part Identification

PVG612	through-hole
PVG612S	surface-mount
PVG612S-T	surface-mount, tape and reel

(HEXFET is the registered trademark for International Rectifier Power MOSFETs)

Series PVG612

International
IRF Rectifier

Electrical Specifications (-40°C ≤ T_A ≤ +85°C unless otherwise specified)

INPUT CHARACTERISTICS	Limits	Units
Minimum Control Current (see figure 1)	5.0	mA
Maximum Control Current for Off-State Resistance @ T _A = +25°C	0.4	mA
Control Current Range (Caution: current limit input LED, see figure 6)	5.0 to 25	mA
Maximum Reverse Voltage	7.0	V

OUTPUT CHARACTERISTICS	Limits	Units
Operating Voltage Range	0 to ±60	V _(DC or AC peak)
Maximum Load Current @ T _A = +40°C, 10mA Control (see figure 1)		
A Connection	1.0	A (AC or DC)
B Connection	1.5	A (DC)
C Connection	2.0	A (DC)
Maximum Pulsed Load Current @ T _A = +25°C (100 ms @ 10% Duty Cycle)		
A Connection	2.4	A (AC or DC)
Maximum On-State Resistance @ T _A = +25°C For 1A pulsed load, 10mA Control (see figure 4)		
A Connection	500	mΩ
B Connection	250	mΩ
C Connection	150	mΩ
Minimum Off-State Resistance @ T _A = +25°C, ±48V (see figure 5)	10 ⁸	Ω
Maximum Turn-On Time @ T _A = +25°C (see figure 7) For 500mA, 50 V _{DC} load, 10mA Control	2.0	ms
Maximum Turn-Off Time @ T _A = +25°C (see figure 7) For 500mA, 50 V _{DC} load, 10mA Control	0.5	ms
Maximum Output Capacitance @ 50V _{DC} (see figure 2)	130	pF

GENERAL CHARACTERISTICS	Limits	Units
Minimum Dielectric Strength, Input-Output	4000	V _{RMS}
Minimum Insulation Resistance, Input-Output, @ T _A = +25°C, 50%RH, 100V _{DC}	10 ¹²	Ω
Maximum Capacitance, Input-Output	1.0	pF
Maximum Pin Soldering Temperature (10 seconds maximum)	+260	
Ambient Temperature Range:		°C
Operating	-40 to +85	
Storage	-40 to +100	

Connection Diagrams

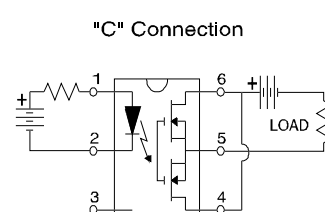
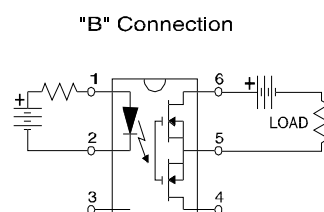
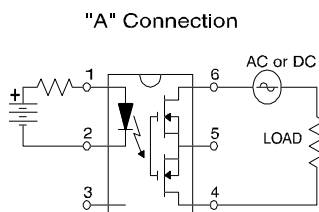

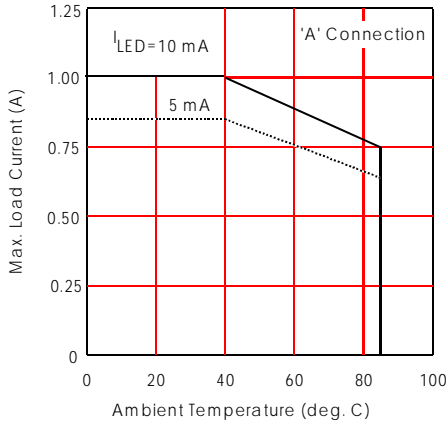

Figure 1. Current Derating Curves*

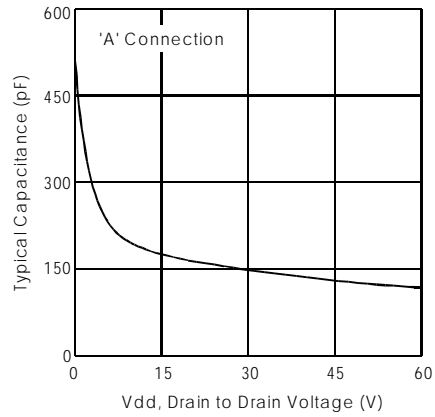

Figure 2. Typical Output Capacitance

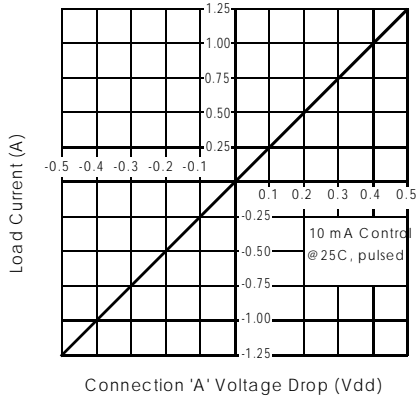

Figure 3. Linearity Characteristics

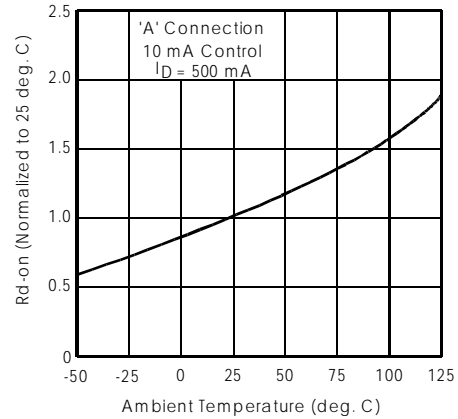

Figure 4. Typical Normalized On-Resistance

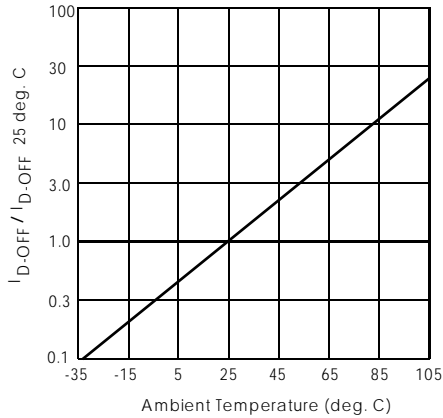

Figure 5. Typical Normalized Off-State Leakage

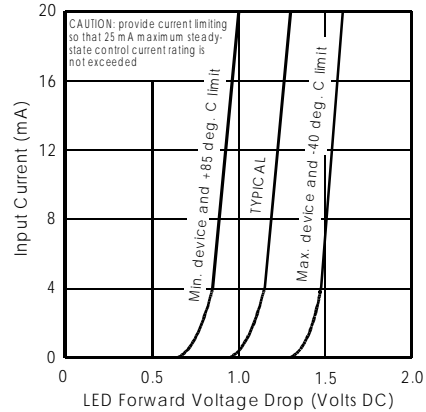

Figure 6. Input Characteristics (Current Controlled)

* Derating of 'B' and 'C' connection at +85°C will be 70% of that specified at +40°C and is linear from +40°C to +85°C.

Series PVG612

International
IR Rectifier

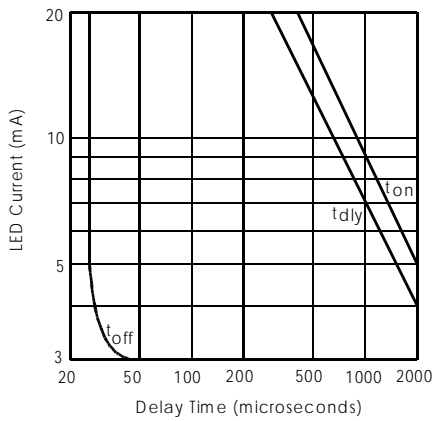

Figure 7. Typical Delay Times

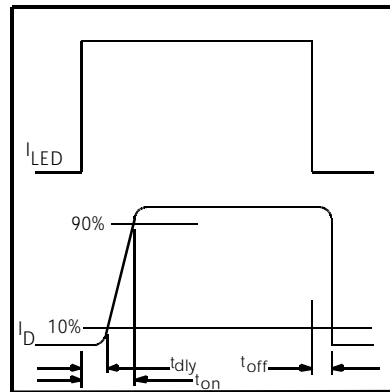
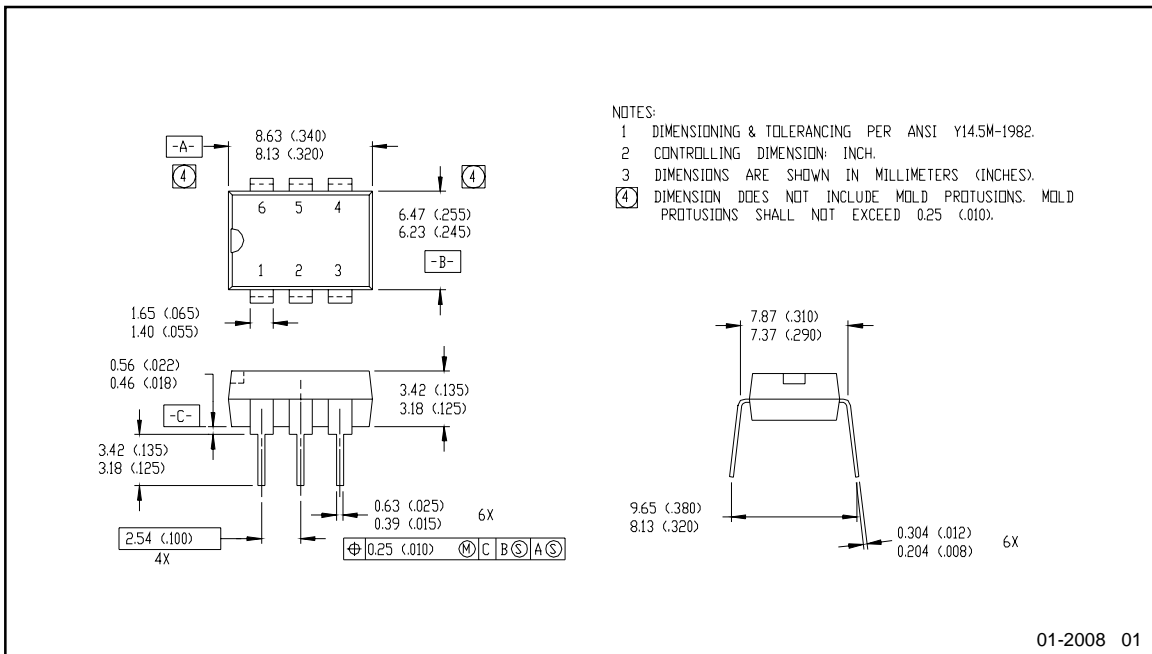

Figure 8. Delay Time Definitions

Case Outline



Case Outline

