

# International IRF Rectifier

# STPS20L15D STPS20L15G

## SCHOTTKY RECTIFIER

20 Amps

### Major Ratings and Characteristics

Characteristics	Values	Units
$I_{F(AV)}$ Rectangular waveform	20	A
$V_{RRM}$	15	V
$I_{FSM}$ @tp=5 $\mu$ s sine	700	A
$V_F$ @19Apk, $T_J=125^\circ\text{C}$ (Typical)	0.25	V
$T_J$ range	-55 to 125	$^\circ\text{C}$

### Description/Features

The Schottky rectifier module has been optimized for ultra low forward voltage drop specifically for the OR-ing of parallel power supplies. The proprietary barrier technology allows for reliable operation up to 125  $^\circ\text{C}$  junction temperature. Typical applications are in parallel switching power supplies, converters, reverse battery protection, and redundant power subsystems.

- 125 $^\circ\text{C}$   $T_J$  operation ( $V_R < 5\text{V}$ )
- Center tap module
- Optimized for OR-ing applications
- Ultra low forward voltage drop
- High frequency operation
- Guard ring for enhanced ruggedness and long term reliability
- High purity, high temperature epoxy encapsulation for enhanced mechanical strength and moisture resistance

### Case Styles

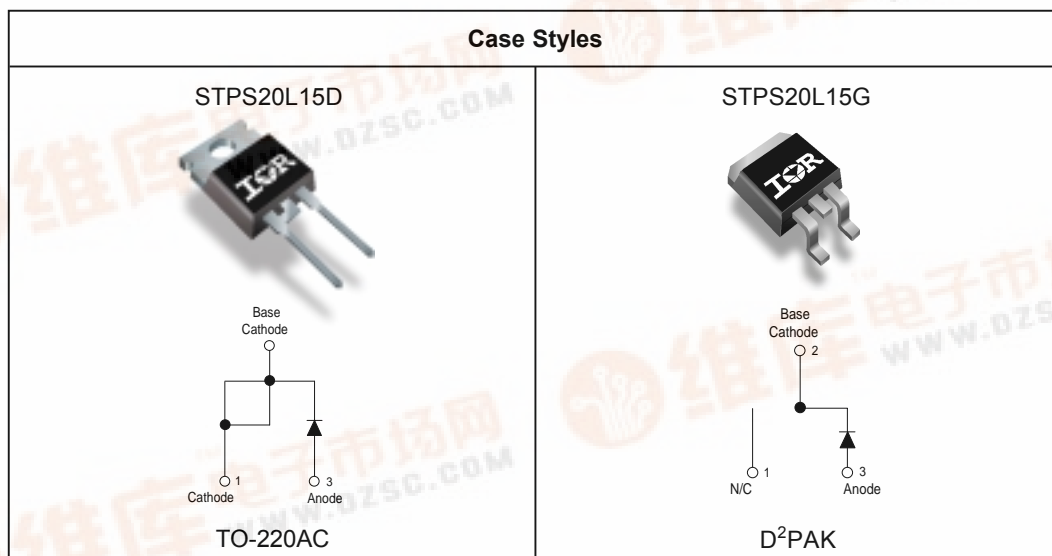

# STPS20L15D, STPS20L15G

Bulletin PD-20626 rev. B 09/01



## Voltage Ratings

Part number	Values
$V_R$ Max. DC Reverse Voltage (V) @ $T_J = 100^\circ\text{C}$	15
$V_{RWM}$ Max. Working Peak Reverse Voltage (V) @ $T_J = 100^\circ\text{C}$	

## Absolute Maximum Ratings

Parameters	Values	Units	Conditions
$I_{F(AV)}$ Max. Average Forward Current * See Fig. 5	20	A	50% duty cycle @ $T_C = 85^\circ\text{C}$ , rectangular waveform
$I_{FSM}$ Max. Peak One Cycle Non-Repetitive Surge Current * See Fig. 7	700	A	5 $\mu\text{s}$ Sine or 3 $\mu\text{s}$ Rect. pulse
	330		10ms Sine or 6ms Rect. pulse
$E_{AS}$ Non-Repetitive Avalanche Energy	10	mJ	$T_J = 25^\circ\text{C}$ , $I_{AS} = 2$ Amps, $L = 6$ mH
$I_{AR}$ Repetitive Avalanche Current	2	A	Current decaying linearly to zero in 1 $\mu\text{sec}$ Frequency limited by $T_J$ max. $V_A = 1.5 \times V_R$ typical

## Electrical Specifications

Parameters	Values		Units	Conditions	
	Typ.	Max.			
$V_{FM}$ Forward Voltage Drop * See Fig. 1 (1)	-	0.41	V	@ 19A	$T_J = 25^\circ\text{C}$
	-	0.52	V	@ 40A	
	0.25	0.33	V	@ 19A	$T_J = 125^\circ\text{C}$
	0.37	0.50	V	@ 40A	
$I_{RM}$ Reverse Leakage Current * See Fig. 2 (1)	-	10	mA	$T_J = 25^\circ\text{C}$	$V_R = \text{rated } V_R$
	-	600	mA	$T_J = 100^\circ\text{C}$	
$V_{F(TO)}$ Threshold Voltage	0.182		V	$T_J = T_J \text{ max.}$	
$r_t$ Forward Slope Resistance	7.6		m $\Omega$		
$C_T$ Max. Junction Capacitance	-	2000	pF	$V_R = 5V_{DC}$ , (test signal range 100Khz to 1Mhz) $25^\circ\text{C}$	
$L_S$ Typical Series Inductance	8	-	nH	Measured lead to lead 5mm from package body	
dv/dt Max. Voltage Rate of Change	10000		V/ $\mu\text{s}$	(Rated $V_R$ )	

(1) Pulse Width < 300 $\mu\text{s}$ , Duty Cycle <2%

## Thermal-Mechanical Specifications

Parameters	Values	Units	Conditions
$T_J$ Max. Junction Temperature Range	-55 to 125	$^\circ\text{C}$	
$T_{stg}$ Max. Storage Temperature Range	-55 to 150	$^\circ\text{C}$	
$R_{thJC}$ Max. Thermal Resistance Junction to Case	1.5	$^\circ\text{C/W}$	DC operation * See Fig. 4
$R_{thCS}$ Typical Thermal Resistance Case to Heatsink	0.50	$^\circ\text{C/W}$	Mounting surface, smooth and greased For TO-220
$R_{thJA}$ Max. Thermal Resistance Junction to Ambient	40	$^\circ\text{C/W}$	DC operation For D <sup>2</sup> Pak
wt Approximate Weight	2(0.07)	g(oz.)	
T Mounting Torque	Min.	6(5)	Kg-cm (lbf-in)
	Max.	12(10)	

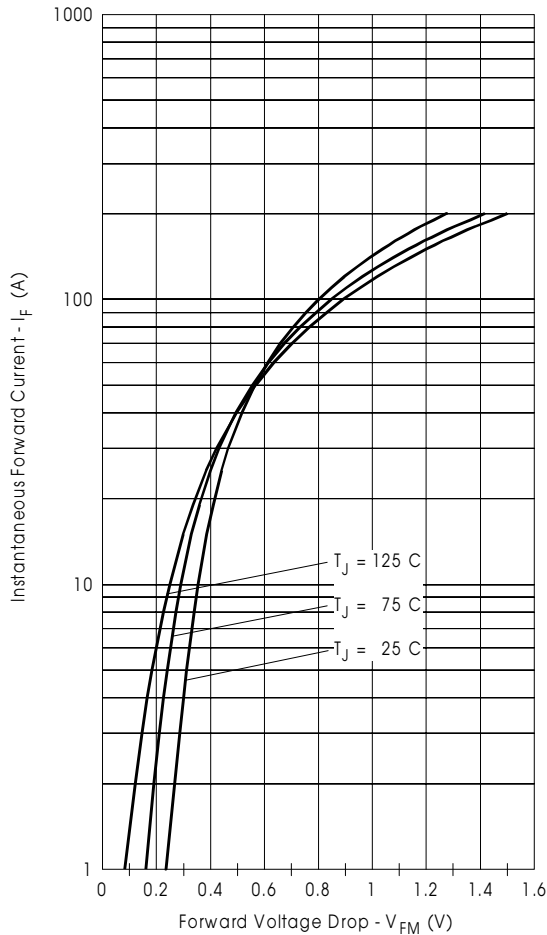

Fig. 1 - Maximum Forward Voltage Drop Characteristics

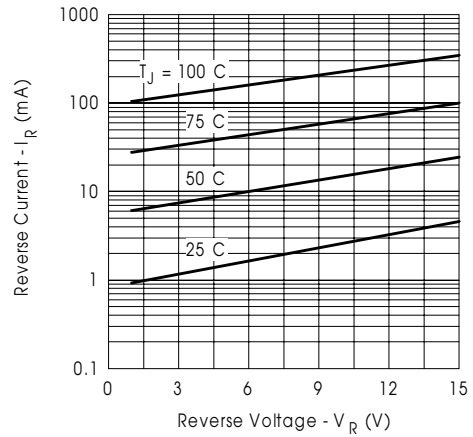

Fig. 2 - Typical Values of Reverse Current Vs. Reverse Voltage

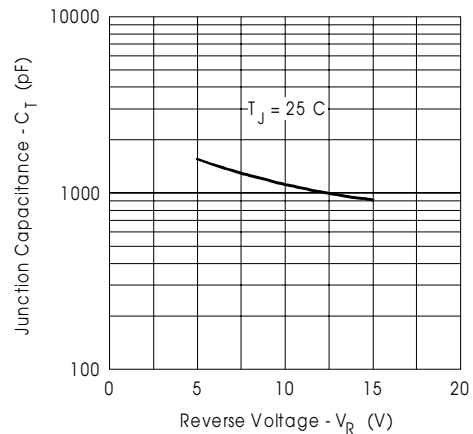

Fig. 3 - Typical Junction Capacitance Vs. Reverse Voltage

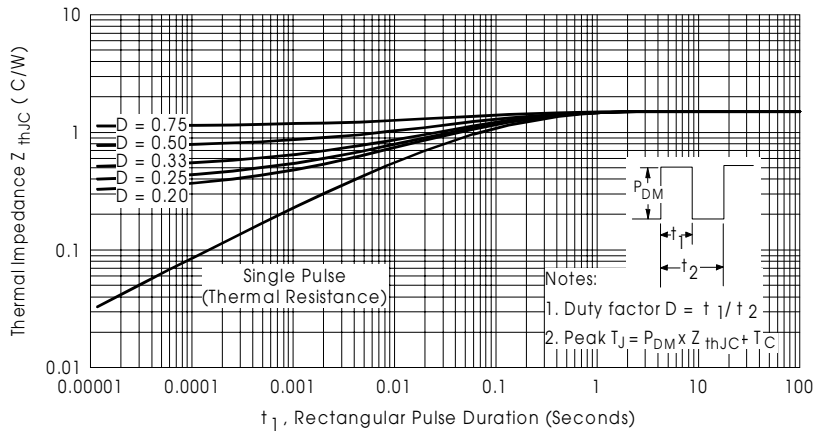

Fig. 4 - Maximum Thermal Impedance  $Z_{thJC}$  Characteristics

# STPS20L15D, STPS20L15G

Bulletin PD-20626 rev. B 09/01

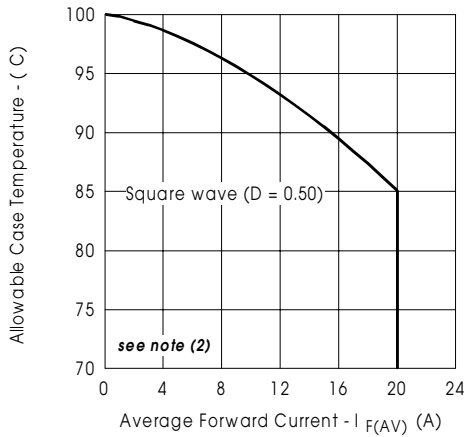

Fig. 5- Maximum Allowable Case Temperature Vs. Average Forward Current

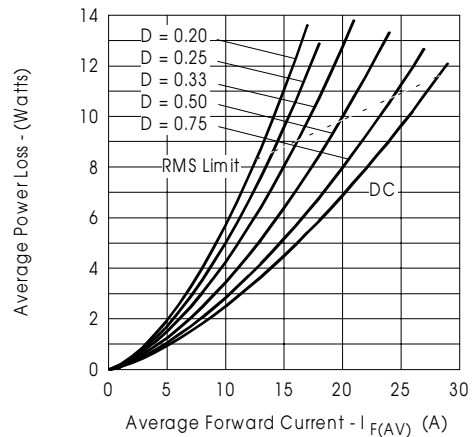

Fig. 6- Forward Power Loss Characteristics

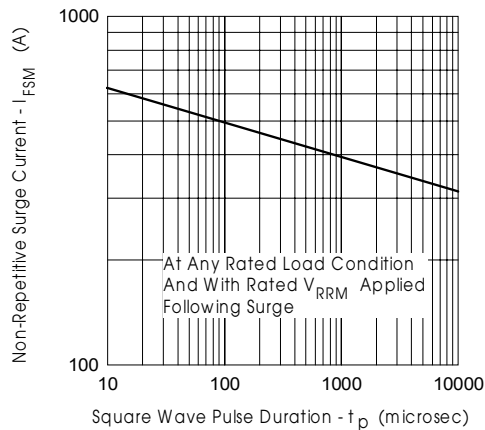

Fig. 7- Maximum Non-Repetitive Surge Current

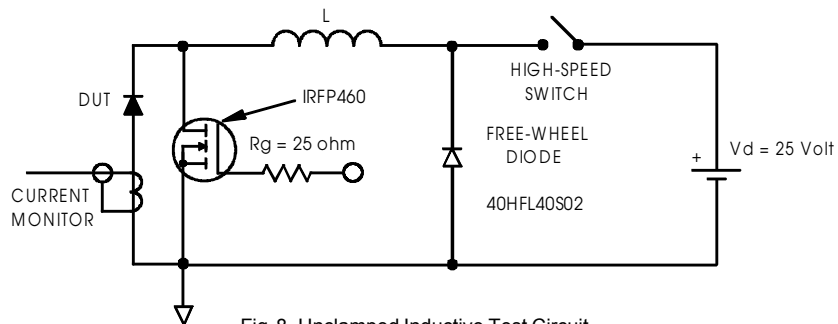
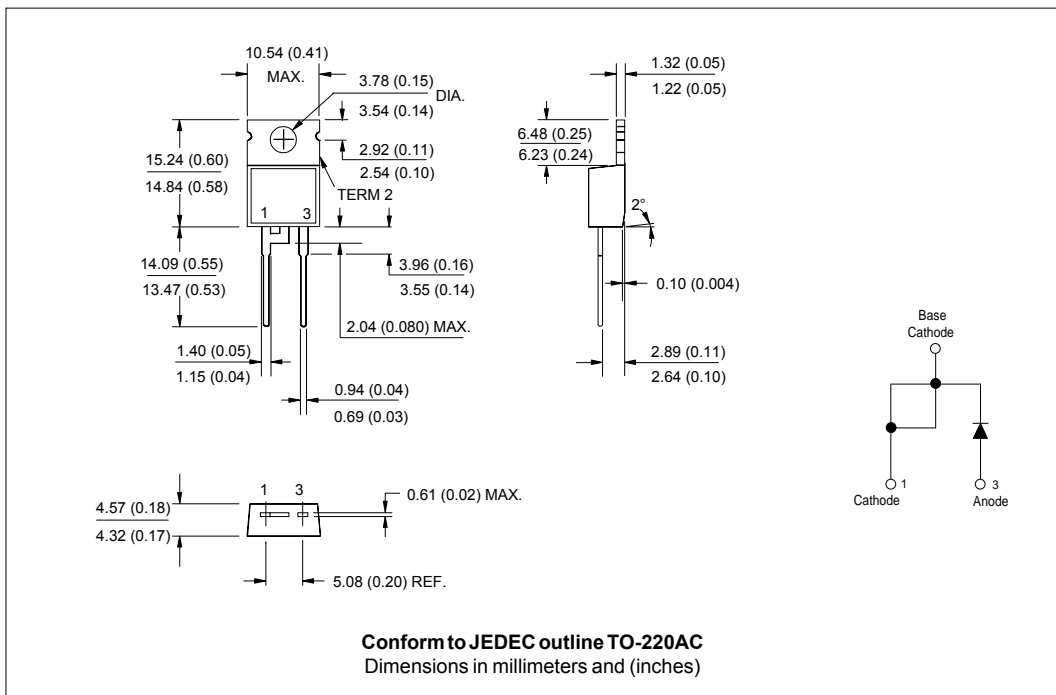
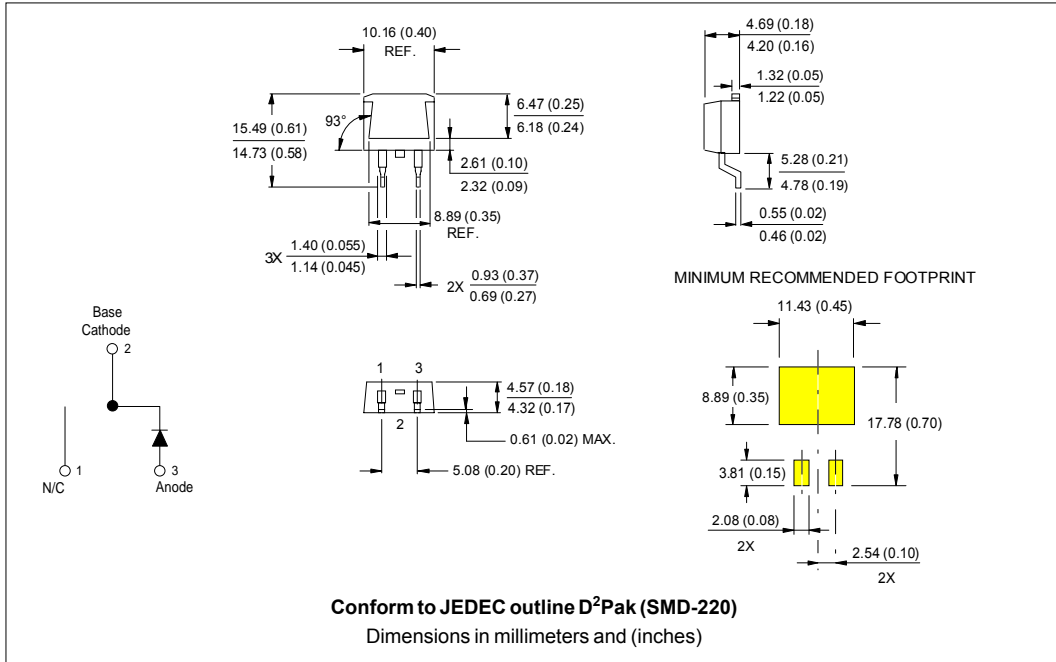

Fig. 8- Unclamped Inductive Test Circuit

- (2) Formula used:  $T_c = T_j - (Pd + Pd_{REV}) \times R_{thJC}$ ;  
 $Pd$  = Forward Power Loss =  $I_{F(AV)} \times V_{FM} @ (I_{F(AV)} / D)$  (see Fig. 6);  
 $Pd_{REV}$  = Inverse Power Loss =  $V_{R1} \times I_R (1 - D)$ ;  $I_R @ V_{R1} = 80\%$  rated  $V_R$

Outline Table



Tape & Reel Information

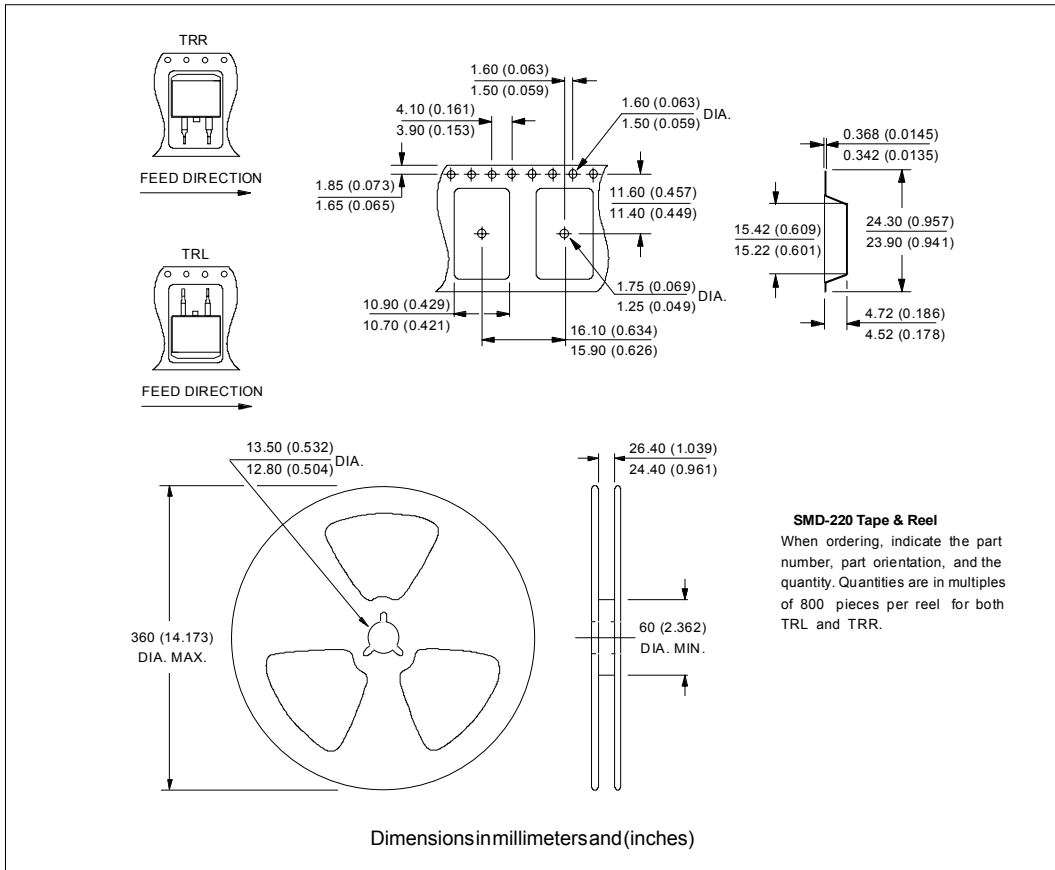

**SMD-220 Tape & Reel**

When ordering, indicate the part number, part orientation, and the quantity. Quantities are in multiples of 800 pieces per reel for both TRL and TRR.

Data and specifications subject to change without notice.  
This product has been designed and qualified for Industrial Level.  
Qualification Standards can be found on IR's Web site.