

Ordering number:EN3008

NPN Epitaxial Planar Silicon Transistor



2SC4364

VHF, UHF/MIX. OSC. Low-Voltage High-Frequency Amplifier Applications

Features

- Low-voltage operation
 - : $f_T=3.0\text{GHz}$ typ ($V_{CE}=3\text{V}$)
 - : $MAG=11\text{dB}$ typ ($V_{CE}=3\text{V}$, $I_C=3\text{mA}$)
 - : $NF=3.0\text{dB}$ typ ($V_{CE}=3\text{V}$, $I_C=3\text{mA}$)

Package Dimensions

unit:mm

2018B

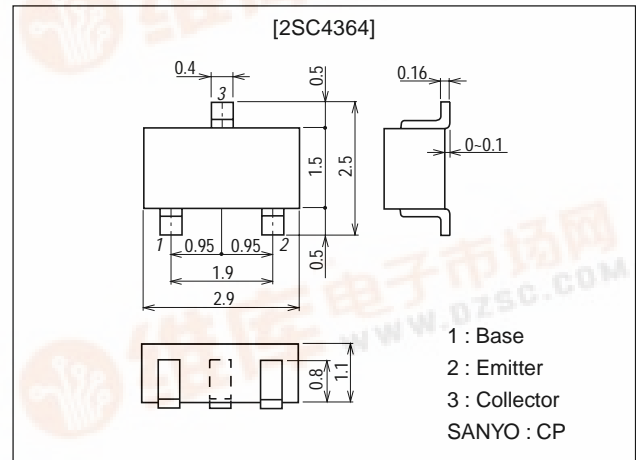

Specifications

Absolute Maximum Ratings at $T_a = 25^\circ\text{C}$

Parameter	Symbol	Conditions	Ratings	Unit
Collector-to-Base Voltage	V_{CBO}		25	V
Collector-to-Emitter Voltage	V_{CEO}		15	V
Emitter-to-Base Voltage	V_{EBO}		3	V
Collector Current	I_C		30	mA
Collector Dissipation	P_C		250	mW
Junction Temperature	T_j		150	$^\circ\text{C}$
Storage Temperature	T_{stg}		-55 to +150	$^\circ\text{C}$

Electrical Characteristics at $T_a = 25^\circ\text{C}$

Parameter	Symbol	Conditions	Ratings			Unit
			min	typ	max	
Collector Cutoff Current	I_{CBO}	$V_{CB}=15\text{V}$, $I_E=0$			1.0	μA
Emitter Cutoff Current	I_{EBO}	$V_{EB}=2\text{V}$, $I_C=0$			1.0	μA
DC Current Gain	h_{FE}	$V_{CE}=3\text{V}$, $I_C=3\text{mA}$	40*		200*	
Gain-Bandwidth Product	f_T	$V_{CE}=3\text{V}$, $I_C=3\text{mA}$		3.0		GHz
Output Capacitance	C_{ob}	$V_{CB}=3\text{V}$, $f=1\text{MHz}$		0.75	1.3	pF
Reverse Transfer Capacitance	C_{re}	$V_{CB}=3\text{V}$, $f=1\text{MHz}$		0.7		pF

* : The 2SC4364 is classified by 3mA h_{FE} as follows :

40	2	80	60	3	120	100	4	200
----	---	----	----	---	-----	-----	---	-----

(Note) Marking : OT

h_{FE} rank : 2, 3, 4

- Any and all SANYO products described or contained herein do not have specifications that can handle applications that require extremely high levels of reliability, such as life-support systems, aircraft's control systems, or other applications whose failure can be reasonably expected to result in serious physical and/or material damage. Consult with your SANYO representative nearest you before using any SANYO products described or contained herein in such applications.
- SANYO assumes no responsibility for equipment failures that result from using products at values that exceed, even momentarily, rated values (such as maximum ratings, operating condition ranges, or other parameters) listed in products specifications of any and all SANYO products described or contained herein.

2SC4364

Parameter	Symbol	Conditions	Ratings			Unit
			min	typ	max	
Forward Transfer Gain	$ S_{21e} ^2$	$V_{CE}=3V, I_C=3mA, f=0.9GHz$		7		dB
Maximum Available Power Gain	MAG	$V_{CE}=3V, I_C=3mA, f=0.9GHz$		11		dB
Noise Figure	NF	$V_{CE}=3V, I_C=3mA, f=0.9GHz$		3.0	5.0	dB

NF Test Circuit

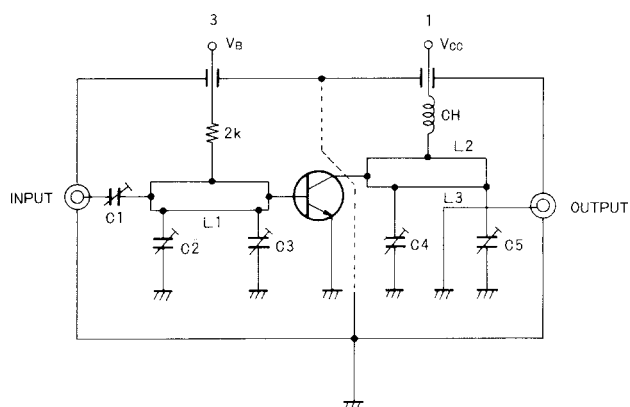

	900MHz
C1	~5pF
C2	~10pF
C3	~10pF
C4	~10pF
C5	~10pF
L1	$W \approx 1.5mm, l \approx 25mm$ Strip line
L2	$W \approx 4mm, l \approx 25mm$ Strip line
L3	$0.5\phi, l \approx 40mm$
CH	2t+bead core

Unit (resistance : Ω)

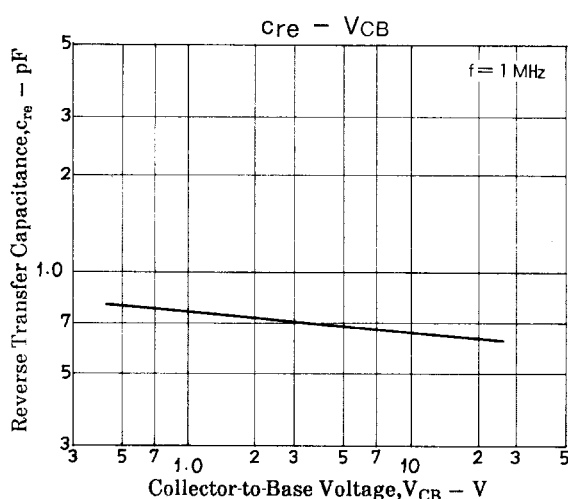
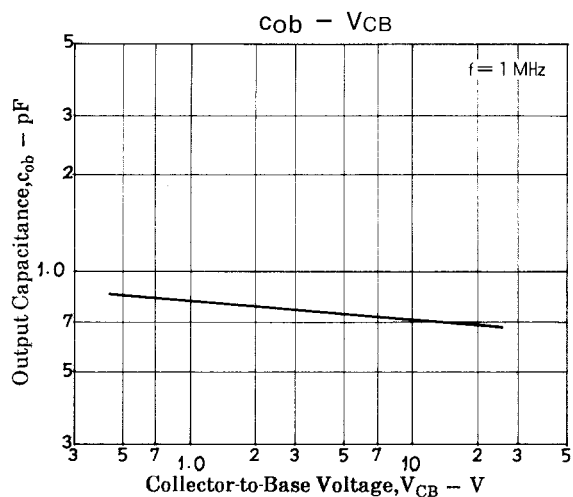
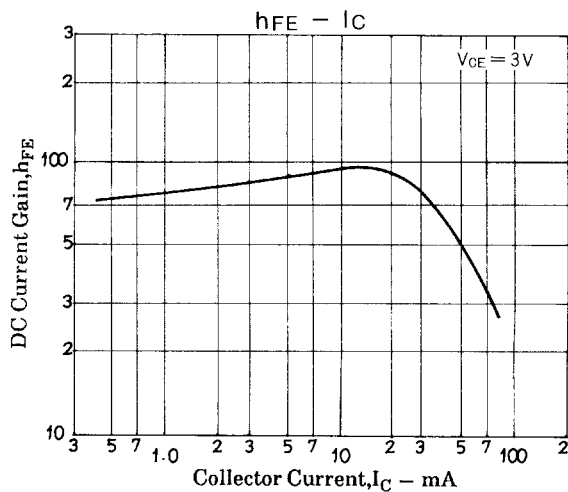
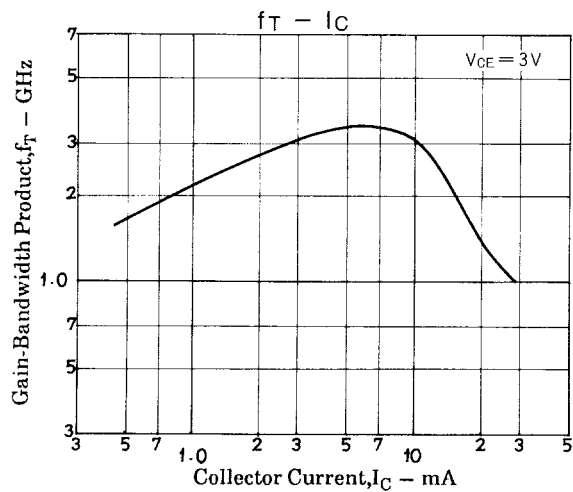

2SC4364

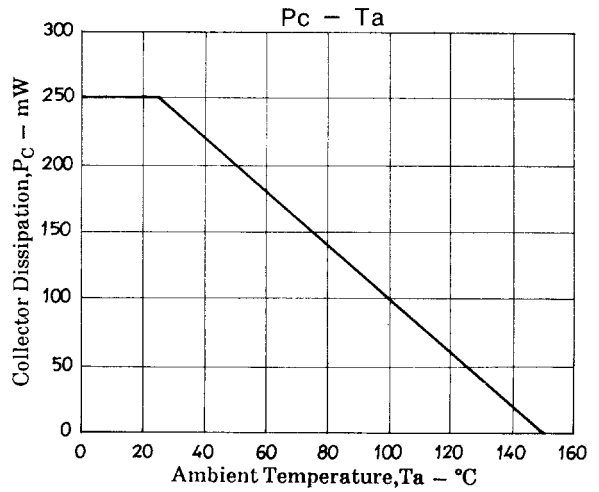
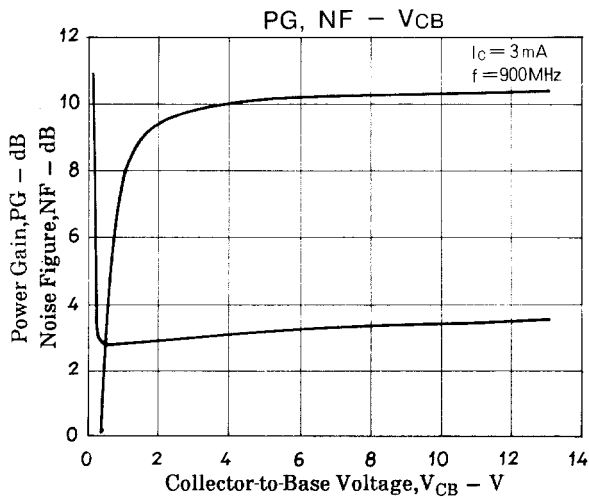
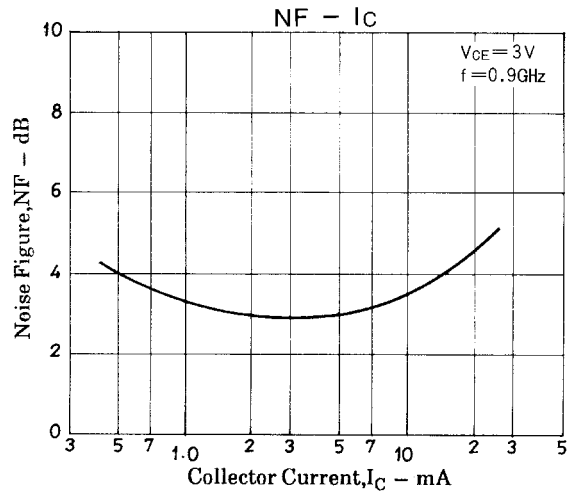
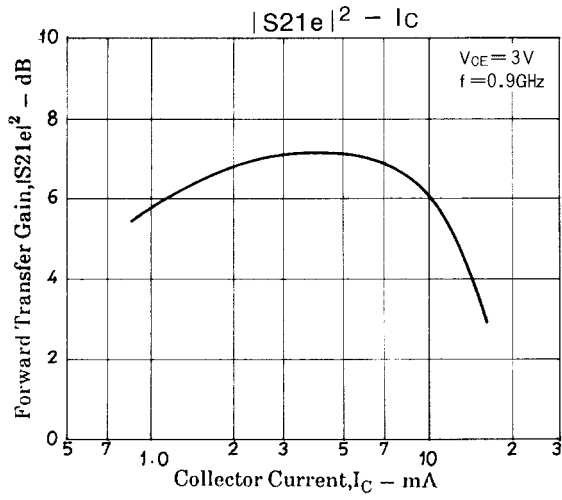

S parameter

S11e : $V_{CE} = 3V$
 $f = 100MHz, 200 \text{ to } 1200MHz (200MHz \text{ step})$

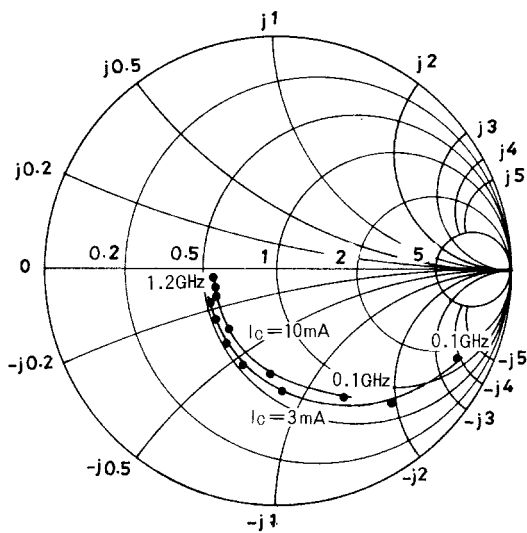

S12e : $V_{CE} = 3V$
 $f = 100MHz, 200 \text{ to } 1200MHz (200MHz \text{ step})$

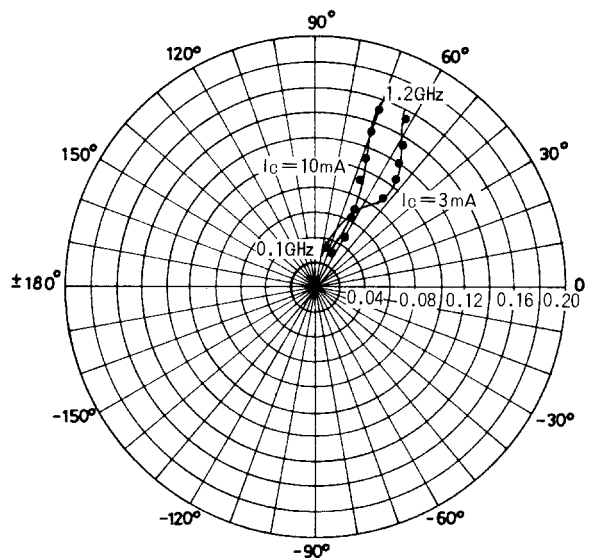

2SC4364

S21e : $V_{CE} = 3V$

$f = 100\text{MHz}$, 200 to 1200MHz (200MHz step)

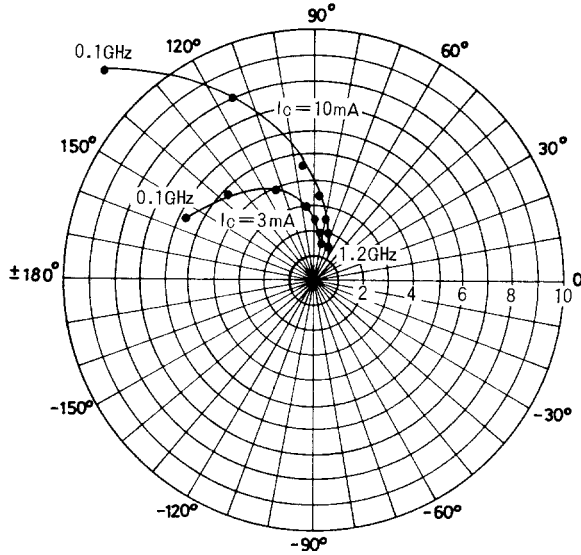

S22e : $V_{CE} = 10V$

$f = 100\text{MHz}$, 200 to 1200MHz (200MHz step)

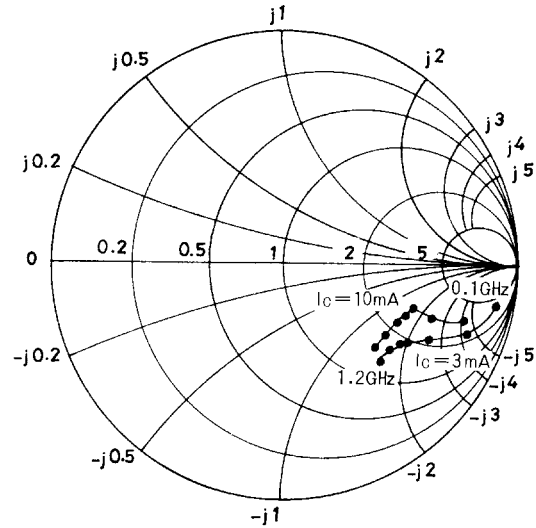

S parameter (Common emitter)

$V_{CE} = 3V$, $I_C = 3mA$, $Z_0 = 50\Omega$

Freq (MHz)	$ S_{11} $	$\angle S_{11}$	$ S_{21} $	$\angle S_{21}$	$ S_{12} $	$\angle S_{12}$	$ S_{22} $	$\angle S_{22}$
100	0.874	-25.4	5.638	154.7	0.036	73.4	0.931	-12.4
200	0.758	-46.8	4.895	137.3	0.061	62.3	0.842	-19.9
400	0.555	-85.9	3.925	112.5	0.088	53.7	0.696	-26.7
600	0.437	-110.1	3.004	97.1	0.105	53.2	0.631	-30.3
800	0.377	-127.8	2.387	86.7	0.119	56.2	0.596	-32.9
900	0.361	-135.3	2.201	82.7	0.128	57.3	0.594	-34.4
1000	0.353	-141.9	2.014	79.1	0.135	56.5	0.586	-36.1
1200	0.340	-151.4	1.763	72.7	0.153	60.6	0.581	-40.1

$V_{CE} = 3V$, $I_C = 10mA$, $Z_0 = 50\Omega$

Freq (MHz)	$ S_{11} $	$\angle S_{11}$	$ S_{21} $	$\angle S_{21}$	$ S_{12} $	$\angle S_{12}$	$ S_{22} $	$\angle S_{22}$
100	0.632	-59.2	11.508	135.2	0.031	63.9	0.811	-18.4
200	0.467	-92.6	7.923	115.1	0.045	58.7	0.677	-21.8
400	0.352	-129.6	4.570	95.5	0.067	61.8	0.584	-22.7
600	0.317	-147.2	3.190	85.3	0.089	65.4	0.561	-25.8
800	0.307	-157.8	2.432	78.1	0.109	68.6	0.548	-29.2
900	0.308	-162.6	2.217	75.1	0.122	69.1	0.551	-31.2
1000	0.314	-166.9	2.023	72.2	0.133	70.1	0.547	-33.3
1200	0.318	-172.2	1.756	67.0	0.156	70.1	0.549	-38.1

- Specifications of any and all SANYO products described or contained herein stipulate the performance, characteristics, and functions of the described products in the independent state, and are not guarantees of the performance, characteristics, and functions of the described products as mounted in the customer's products or equipment. To verify symptoms and states that cannot be evaluated in an independent device, the customer should always evaluate and test devices mounted in the customer's products or equipment.
- SANYO Electric Co., Ltd. strives to supply high-quality high-reliability products. However, any and all semiconductor products fail with some probability. It is possible that these probabilistic failures could give rise to accidents or events that could endanger human lives, that could give rise to smoke or fire, or that could cause damage to other property. When designing equipment, adopt safety measures so that these kinds of accidents or events cannot occur. Such measures include but are not limited to protective circuits and error prevention circuits for safe design, redundant design, and structural design.
- In the event that any or all SANYO products (including technical data, services) described or contained herein are controlled under any of applicable local export control laws and regulations, such products must not be exported without obtaining the export license from the authorities concerned in accordance with the above law.
- No part of this publication may be reproduced or transmitted in any form or by any means, electronic or mechanical, including photocopying and recording, or any information storage or retrieval system, or otherwise, without the prior written permission of SANYO Electric Co., Ltd.
- Any and all information described or contained herein are subject to change without notice due to product/technology improvement, etc. When designing equipment, refer to the "Delivery Specification" for the SANYO product that you intend to use.
- Information (including circuit diagrams and circuit parameters) herein is for example only ; it is not guaranteed for volume production. SANYO believes information herein is accurate and reliable, but no guarantees are made or implied regarding its use or any infringements of intellectual property rights or other rights of third parties.