

# MAXIM

## MAX5052A Evaluation Kit

### General Description

The MAX5052A evaluation kit (EV kit) is a fully assembled and tested circuit board that contains a 9W flyback DC-to-DC converter. The circuit is configured for output voltages of +5V and +15V and provides up to 1.5A and 100mA of current at each respective output. Power for the circuit can be provided from either a +36VDC to +72VDC or -36VDC to -72VDC source.

High efficiency up to 83% is achieved using a single-transistor, flyback DC-to-DC converter topology. The surface-mount transformer provides up to 1500V galvanic isolation of both outputs. Low cost is achieved through the use of primary-side regulation while undervoltage lockout (UVLO), digital soft-start, and thermal shutdown provide for a robust 9W isolated power supply.

Operation at 262kHz allows the use of small magnetics and output capacitors.

**Warning:** *The MAX5052A EV kit is designed to operate with high voltages. Dangerous voltages are present on the MAX5052A EV kit and on equipment connected to it. Users who power up the MAX5052A EV kit or power the sources connected to it must be careful to follow safety procedures appropriate to working with high-voltage electrical equipment.*

*Under severe fault or failure conditions, the MAX5052A EV kit may dissipate large amounts of power, which could result in the mechanical ejection of a component or of component debris at high velocity. Operate MAX5052A EV kit with care to avoid possible personal injury.*

### Features

- ◆ +36VDC to +72VDC or -36VDC to -72VDC Input Voltage Range
- ◆ Isolated Outputs
  - VOUT1: +5V Provides Up to 1.5A
  - VOUT2: +15V Provides Up to 100mA
- ◆ ±5% (typ) Load Regulation for the +5V Output (150mA to 1.5A)
- ◆ 83% Efficiency at 48V Input and Full Load
- ◆ Cycle-by-Cycle Current Limit
- ◆ 262kHz Switching Frequency
- ◆ Digital Soft-Start
- ◆ Undervoltage Lockout (UVLO)
- ◆ Designed for 1500V Isolation with Primary-Side Regulation
- ◆ Low-Cost Flyback Design
- ◆ Fully Assembled and Tested

### Ordering Information

PART	TEMP RANGE	IC PACKAGE
MAX5052AEVKIT	0°C to +70°C	8 µMAX

### Component Suppliers

SUPPLIER	PHONE	FAX	WEBSITE
Central Semiconductor	631-435-1110	631-435-1824	www.centralsemi.com
Cooper-Coiltronics	561-752-5000	561-742-1178	www.cooperet.com
Dale-Vishay	402-564-3131	402-563-6296	www.vishay.com
Diodes Inc.	805-446-4800	805-446-4850	www.diodes.com
Fair-Rite Products	845-895-2055	845-895-2629	www.fair-rite.com
International Rectifier	310-322-3331	310-726-8721	www.irf.com
Kemet	864-963-6300	864-963-6322	www.kemet.com
Murata	770-436-1300	770-436-3030	www.murata.com
Panasonic	714-373-7366	714-737-7323	www.panasonic.com
TDK	847-803-6100	847-390-4405	www.component.tdk.com
Telefunken-Vishay	402-563-6325	N/A	www.vishay.com
Zetex USA	631-543-7100	631-864-7630	www.zetex.com

Note: Please indicate that you are using the MAX5052A when contacting these component suppliers.

# MAX5052A Evaluation Kit

## Component List

DESIGNATION	QTY	DESCRIPTION
C1, C2	2	1 $\mu$ F $\pm$ 10%, 100V X7R ceramic capacitors (1812) TDK C4532X7R2A105K
C3	1	68 $\mu$ F, 6.3V electrolytic capacitor (V case) Kemet A700V686M006AT
C4	1	22 $\mu$ F $\pm$ 20%, 6.3V X5R ceramic capacitor (1206) TDK C3216X5R0J226M
C5	1	47 $\mu$ F, 25V electrolytic capacitor (6.3 x 5.8) Panasonic EEVFK1E470P
C6	1	0.0047 $\mu$ F $\pm$ 10%, 250VAC X7R ceramic capacitor (2220) Murata GA355DR7GC472KY02L
C7, C11, C12	3	0.22 $\mu$ F $\pm$ 10%, 50V X7R ceramic capacitors (0805) Murata GRM21BR71H224KA01B
C8, C10	0	Not installed, ceramic capacitors (0603)
C9	1	2200pF $\pm$ 10%, 50V X7R ceramic capacitor (0603) TDK C1608X7R1H222K
C13	1	1 $\mu$ F $\pm$ 10%, 16V X7R ceramic capacitor (0805) TDK C2012X7R1C105KT
C14	1	0.022 $\mu$ F $\pm$ 10%, 50V X7R ceramic capacitor (0603) TDK C1608X7R1H223KT
C15	1	1 $\mu$ F $\pm$ 10%, 25V X7R ceramic capacitor (0805) TDK C2012X7R1E105KT
C16	1	15 $\mu$ F $\pm$ 10%, 35V tantalum capacitor (D case) Kemet T491D156K035AS
C17	0	Not installed, ceramic capacitor (0805)
D1	1	40V, 10A Schottky diode (POWERMITE 3) Diodes Inc. SBM1040

DESIGNATION	QTY	DESCRIPTION
D2	1	200V, 1.5A super-fast diode (SMD) Vishay/Telefunken BYG20D
D3	0	Not installed; 250V, 250mA high-voltage switching diode (SOD-123) Central Semiconductor CMHD2003 (when used)
D4	1	5.6V, 0.5W zener diode (SOD-123) Diodes Inc. BZT52C5V6
D5	1	18V, 0.5W zener diode (SOD-123) Diodes Inc. BZT52C18
D6	1	75V, 250mA high-speed diode (SOT23) Central Semiconductor CMPD914
D7	0	Not installed; 14V, 250mW zener diode (SOD-323) Central Semiconductor CMDZ5244B (when used)
D8	1	40V 0.5A Schottky diode (SOT23) Zetex ZHCS500
JU1	1	2-pin header
L1	1	3A ferrite bead inductor (1806) Fair-Rite 2518066007Y3
L2	1	100mA ferrite bead inductor (0805) Fair-Rite 2508051027Y0
N1	1	200V, 1.2A N-channel MOSFET (8-pin SO) International Rectifier IRF7464
R1	1	22.6k $\Omega$ $\pm$ 1% resistor (0603)
R2	1	2.49k $\Omega$ $\pm$ 1% resistor (0603)
R3	1	1M $\Omega$ $\pm$ 1% resistor (0805)
R4	1	42.2k $\Omega$ 1% resistor (0805)
R5	1	0.170 $\Omega$ $\pm$ 1% power resistor (1206) Dale-Vishay WSL-12060.170 $\Omega$ $\pm$ 1%
R6	1	33k $\Omega$ $\pm$ 5% resistor (1206)
R7, R12	2	1.2k $\Omega$ $\pm$ 5% resistors (1206)
R8	0	Not installed
R9	1	14.3k $\Omega$ $\pm$ 1% resistor (0603)
R10	1	0 $\Omega$ $\pm$ 5% resistor (0805)
R11	1	100 $\Omega$ $\pm$ 5% resistor (0603)

# MAX5052A Evaluation Kit

## Component List (continued)

DESIGNATION	QTY	DESCRIPTION
T1	1	35 $\mu$ H, 10W transformer (10-pin Gull Wing) Cooper-Coiltronics CTX03-16034
U1	1	MAX5052AEUA (8-pin $\mu$ MAX)
None	1	Shunt (JU1)
None	1	MAX5052A PC board

## Quick Start

The MAX5052A EV kit is fully assembled and tested. Follow these steps to verify board operation. **Do not turn on the power supply until all connections are completed.**

### Outputs

- 1) Connect a voltmeter to the VOUT1 pad and SGND.
- 2) Connect a second voltmeter to the VOUT2 pad and SGND.
- 3) Connect a 750mA load to VOUT1 and a 50mA load to VOUT2.
- 4) Verify that a shunt is not installed across the pins of jumper JU1 (SHDN).
- 5) Connect a +36V to +72V power supply to the +VIN pad. **Do not exceed 100V input voltage.** Connect the power supply's ground to the -VIN pad.
- 6) Turn on the power supply above +36V and verify that the voltmeter at VOUT1 reads approximately +5V.
- 7) Verify that the voltmeter at VOUT2 reads approximately +15V.

The maximum current for each output should be limited to less than 1.5A for VOUT1 and 100mA for VOUT2. For instructions on selecting the feedback resistors for other output voltages, see the *Evaluating Other Output Voltages, Current Limits, and UVLO* section.

## Detailed Description

The MAX5052A EV kit is a 9W, isolated flyback DC-to-DC converter that provides +5V and +15V outputs. The +5V output, VOUT1, can provide up to 1.5A and the +15V output, VOUT2, can provide up to 100mA. The circuit can be powered from a +36VDC to +72VDC or a -36VDC to -72VDC source. **The user must supply at least 22 $\mu$ F of bulk-storage capacitance at the input terminals (+VIN, -VIN).** The capacitor should be rated for 100V and be able to carry approximately 200mA of ripple current.

The flyback DC-to-DC converter achieves up to 83% efficiency. The single-transistor topology and primary-side regulation provide for a low-cost design by eliminating the need for an optocoupler and shunt reference on the secondary side. The MAX5052 EV kit provides cycle-by-cycle, primary-side current-limit protection. The current-sense resistor, R5, senses the current through the transformer's (T1) primary winding. Switching transistor (N1) turns off when the trip level of 291mV is reached. The surface-mount transformer provides galvanic isolation up to 1500V for both outputs. The MAX5052A EV kit features PC board pads for an RCD snubber network (R8, C10, D3) to minimize leakage-energy ringing and to clamp the voltage at the drain of MOSFET (N1) during switching (with most MOSFETs, this snubber circuit can be eliminated).

Primary-side regulation through feedback resistors R1, R2, rectifier D6, and the T1 tertiary winding provides  $\pm 5\%$  regulation for the outputs. R7 and R12 are adjusted to preload the tertiary winding for the +5V  $\pm 5\%$  output regulation. UVLO provides controlled turn-on and shut-down during brownouts when powering up or powering down. The UVLO settings can be changed by replacing R4. Startup resistor R6 and reservoir capacitor C16 enable the MAX5052A to start up within approximately 500ms. The digital soft-start allows the output voltage to slowly ramp up in a controlled manner within 60ms. The MAX5052A controller switches at a fixed 262kHz frequency and the duty cycle is varied to control energy transfer to the isolated outputs. The maximum duty cycle is 50% for the MAX5052A EV kit's discontinuous current-mode flyback design.

# MAX5052A Evaluation Kit

**Table 1. Jumper JU1 Shutdown Mode**

SHUNT LOCATION	MAX5052A UVLO/EN Pin	MAX5052A OUTPUT
None	UVLO resistors R3 and R4 determine startup voltage	MAX5052A enabled: VOUT1 = +5V VOUT2 = +15V
Installed	Pulled low to -VIN	Shutdown mode

### Shutdown Mode and Remote-Control Method

The MAX5052A EV kit features two methods to shut down the flyback DC-to-DC converter. Jumper JU1 can be used to shut down the flyback DC-to-DC converter. An alternate method, remote control shutdown, can be achieved with a user-supplied open collector/drain transistor or relay contact connected to the  $\overline{\text{SHDN}}$  and -VIN pads of the MAX5052A EV kit. Table 1 lists the shutdown mode.

### Evaluating Other Output Voltages, Current Limits, and UVLO

#### VOUT1 and VOUT2 Output Voltages

The MAX5052A EV kit's outputs, VOUT1 and VOUT2, are set to +5V and +15V, respectively, by transformer T1's tertiary turns. The transformer's respective secondary-output turns, and the resistor-dividers R1 and R2 set the output voltages. To generate scaled-output voltages other than +5V (+4.2V to +6.8V) and +15V (+12.3V to +20.2V), select different voltage-divider resistors (R1, R2). R2 is typically chosen to be less than 5k $\Omega$ . **When evaluating other output voltages, verify that the secondary outputs' components affected by increased voltage are rated appropriately. Components D1, C3, C4, C13, and D4 of VOUT1 and components D2, C5, C15, and D5 should have their respective voltage rating evaluated.** Using the desired scaled-output voltages, calculate R1 using the following equation:

$$R1 = \left[ \frac{(V_{\text{OUT1}} - V_{\text{VD1}}) \times \frac{N_{\text{T}}}{N_{\text{1}}} - V_{\text{VD6}}}{V_{\text{FB}}} - 1 \right] \times R2$$

where VOUT1 is the +5V output, NT is the transformer's tertiary turns = 15, N1 is the transformer's secondary

VOUT1 number of turns = 6, VFB is the MAX5052A reference voltage = 1.23V, VVD6 is the circuit's tertiary-winding high-speed diode (D6) forward-voltage drop = 1.0V, VVD1 is the circuit's secondary-side Schottky diode (D1) forward-voltage drop of 0.45V (typ).

Both output voltages are scaled up or down since the respective transformer's secondary-output turns set the actual voltage. Additionally, the maximum current for each output should be limited to less than 1.5A for VOUT1 and 100mA for VOUT2.

### Current Limiting

The MAX5052A EV kit features current limiting for the transformer's primary current. The MAX5052A IC turns off switching MOSFET N1 when the voltage at the MAX5052A CS pin reaches 291mV. Current-sense resistor R5 (0.170 $\Omega$ ) limits the transformer peak-primary current to 1.71A (291mV/0.170 $\Omega$  = 1.71A). This limits the average short-circuit current on the secondary outputs typically to 1.2A (average) and 200mA (average) for VOUT1 and VOUT2, respectively. To evaluate a lower current limit, R5 must be replaced with a different surface-mount resistor (1206 size) as determined by the following equation:

$$R5 = \frac{V_{\text{SENSE}}}{I_{\text{PRIMARY}}}$$

where VSENSE = 291mV and IPRIMARY is the transformer's maximum primary current.

### Undervoltage Lockout (UVLO)

The MAX5052A EV kit features a UVLO circuit that prevents operation below the programmed input-supply start voltage. R3 and R4 set the voltage at the MAX5052A's UVLO/EN pin that determines the UVLO wakeup and shutdown levels, 1.28V (typ) and 1.23V (typ), respectively. To evaluate other wakeup and shutdown levels, replace R4 with another surface-mount resistor (0805 size). Refer to the MAX5052/MAX5053 Undervoltage Lockout section in the MAX5052/MAX5053 data sheet for instructions on selecting R4 as determined by the following equation:

$$R3 = ((V_{\text{IN}} - V_{\text{UVLO}}) / V_{\text{UVLO}}) \times R4$$

where VIN is the  $\pm 36\text{V}$  to  $\pm 72\text{V}$  supply voltage applied between the +VIN and -VIN pads of the MAX5052A EV kit and VUVLO = 1.28V (typ).

# MAX5052A Evaluation Kit

## Flyback Converter Waveforms

Evaluates: MAX5052A

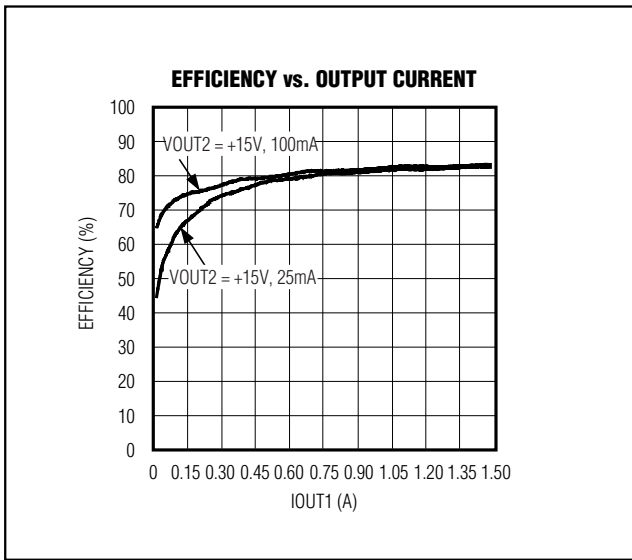

Figure 1. Efficiency vs. Output Current  $I_{OUT1}$ ,  $V_{IN} = 48V$

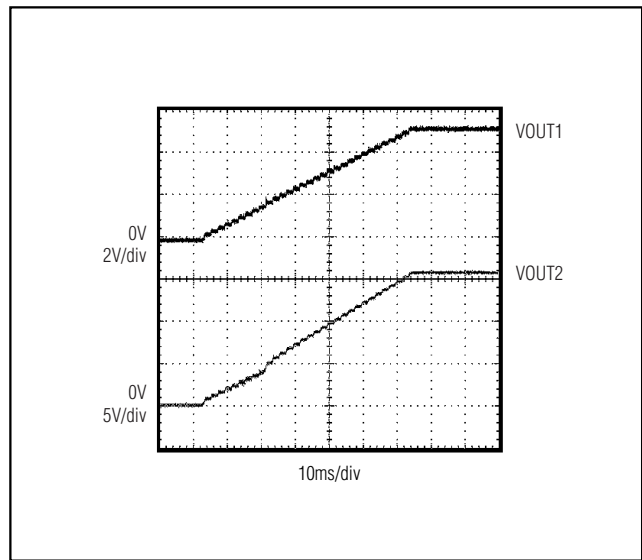

Figure 2. Output Voltage Transient at Power-Up,  $V_{IN} = 48V$ , Channel 1 =  $V_{OUT1}$  ( $I_{OUT1} = 150mA$ ), Channel 2 =  $V_{OUT2}$  ( $I_{OUT2} = 25mA$ )

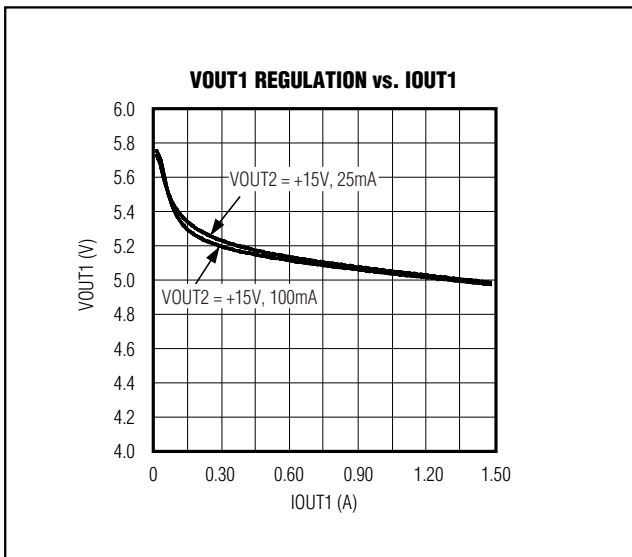

Figure 3.  $V_{OUT1}$  (+5V) Output Voltage Regulation

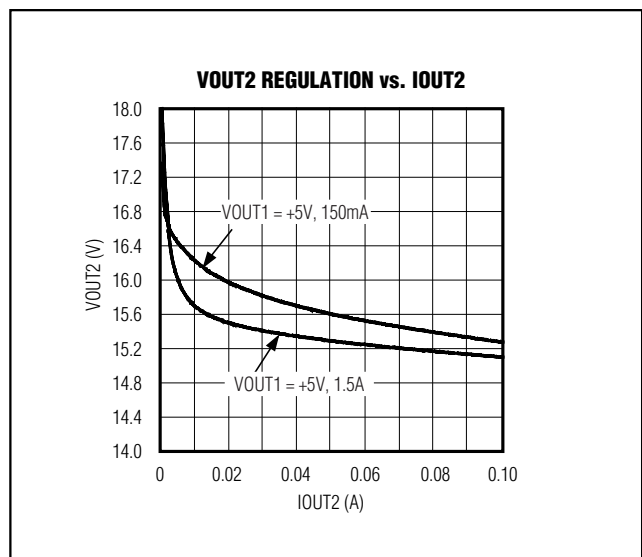

Figure 4.  $V_{OUT2}$  (+15V) Output Voltage Regulation

# MAX5052A Evaluation Kit

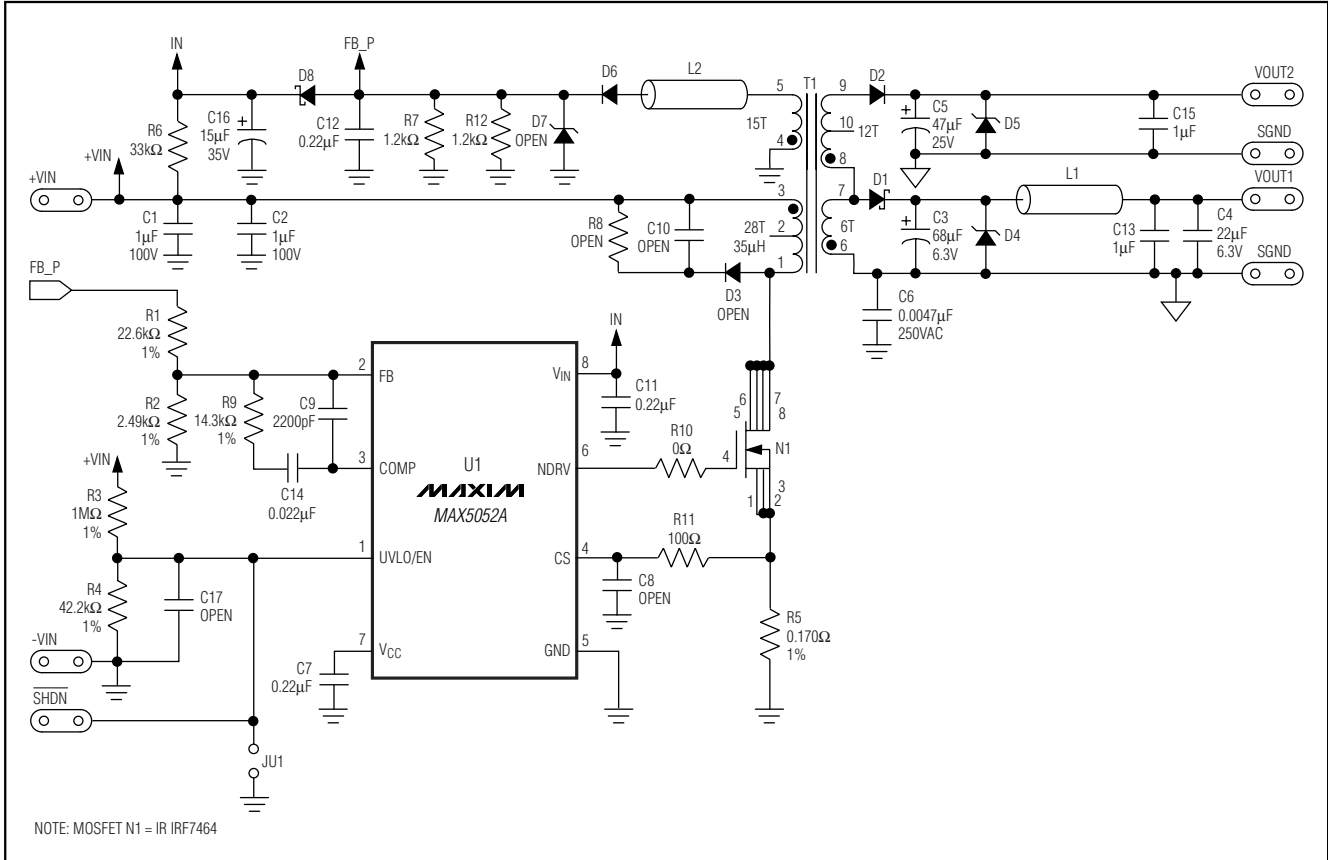

Figure 5. MAX5052A EV Kit Schematic

# MAX5052A Evaluation Kit

Evaluates: MAX5052A

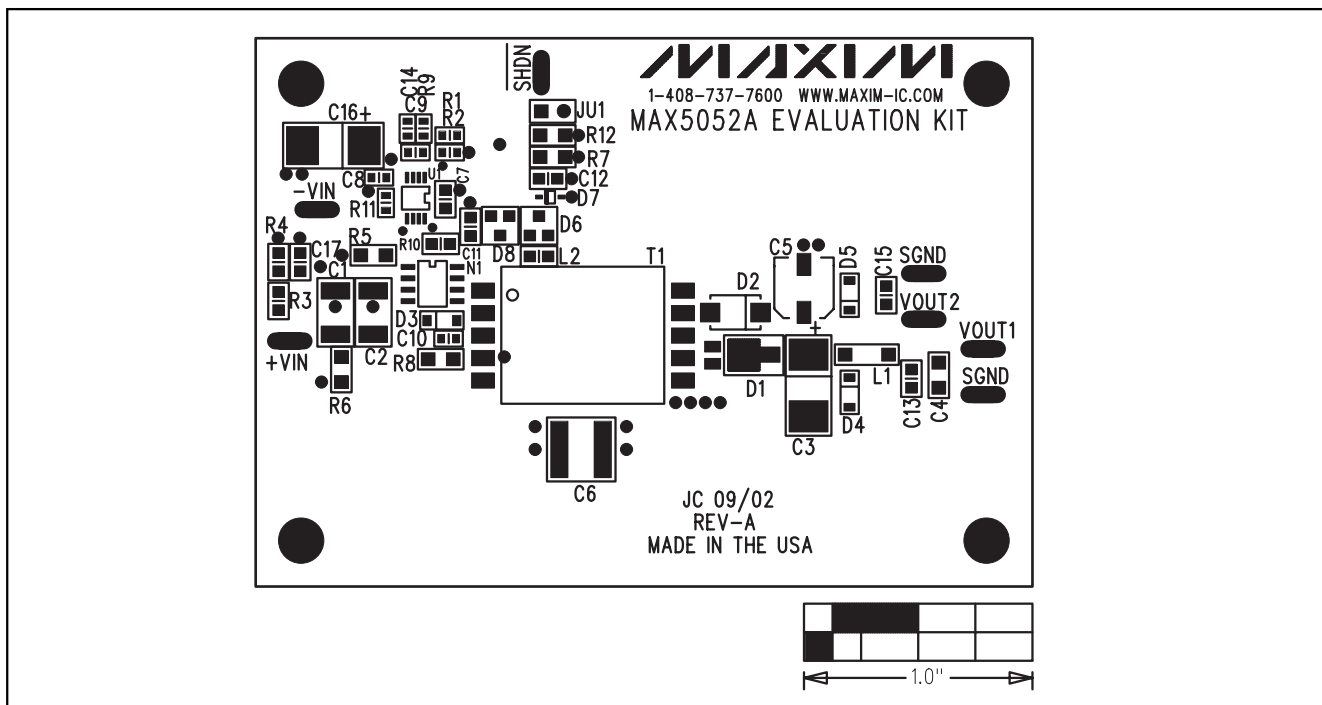

Figure 6. MAX5052A EV Kit Component Placement Guide—Component Side

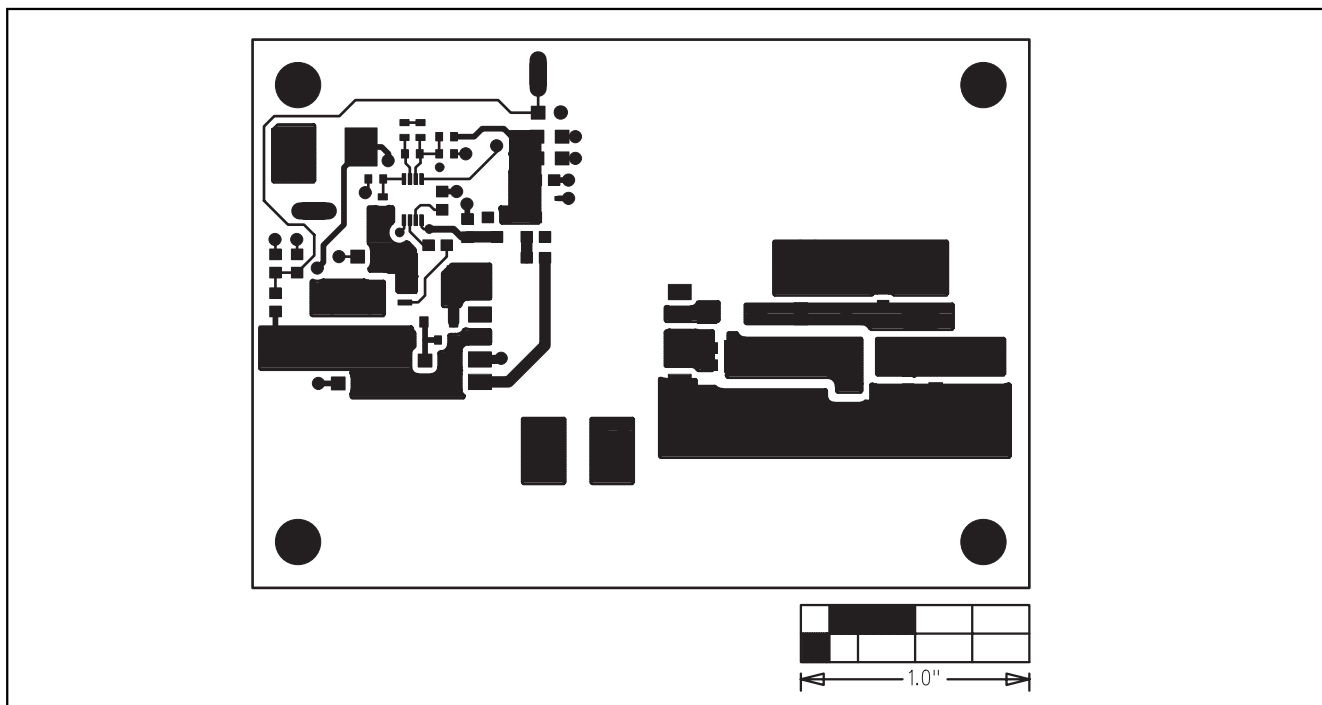

Figure 7. MAX5052A EV Kit PC Board Layout—Component Side

# MAX5052A Evaluation Kit

Evaluates: MAX5052A

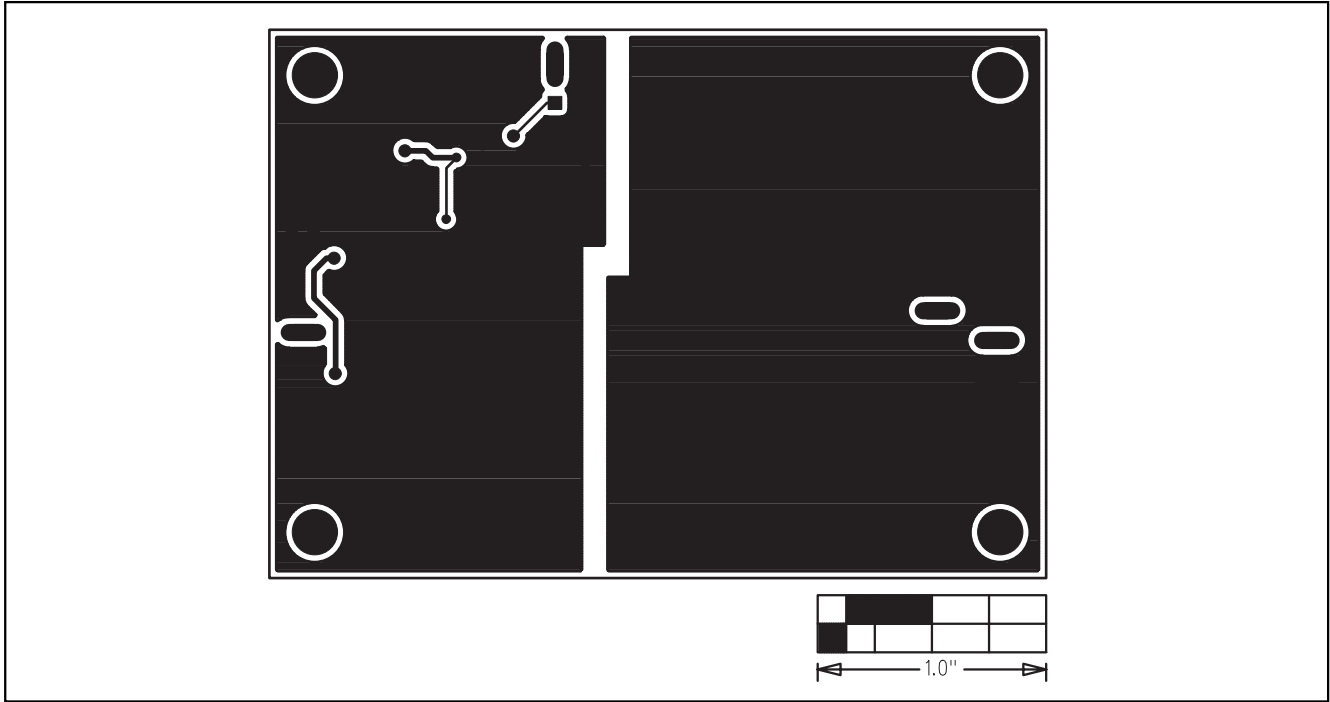

Figure 8. MAX5052A EV Kit PC Board Layout—Solder Side

Maxim cannot assume responsibility for use of any circuitry other than circuitry entirely embodied in a Maxim product. No circuit patent licenses are implied. Maxim reserves the right to change the circuitry and specifications without notice at any time.

8 **Maxim Integrated Products, 120 San Gabriel Drive, Sunnyvale, CA 94086 408-737-7600**

© 2003 Maxim Integrated Products

Printed USA

**MAXIM** is a registered trademark of Maxim Integrated Products.