



LT1764A Series

3A, Fast Transient Response, Low Noise, LDO Regulators

FEATURES

- Optimized for Fast Transient Response
- Output Current: 3A
- Dropout Voltage: 340mV at 3A
- Low Noise: 40 μ V_{RMS} (10Hz to 100kHz)
- 1mA Quiescent Current
- Wide Input Voltage Range: 2.7V to 20V
- No Protection Diodes Needed
- Controlled Quiescent Current in Dropout
- Fixed Output Voltages: 1.5V, 1.8V, 2.5V, 3.3V
- Adjustable Output from 1.21V to 20V
- <1 μ A Quiescent Current in Shutdown
- Stable with 10 μ F Output Capacitor
- Stable with Ceramic Capacitors
- Reverse Battery Protection
- No Reverse Current
- Thermal Limiting

APPLICATIONS

- 3.3V to 2.5V Logic Power Supply
- Post Regulator for Switching Supplies

DESCRIPTION

The LT[®]1764A is a low dropout regulator optimized for fast transient response. The device is capable of supplying 3A of output current with a dropout voltage of 340mV. Operating quiescent current is 1mA, dropping to <1 μ A in shutdown. Quiescent current is well controlled; it does not rise in dropout as it does with many other regulators. In addition to fast transient response, the LT1764A has very low output voltage noise which makes the device ideal for sensitive RF supply applications.

Output voltage range is from 1.21V to 20V. The LT1764A regulators are stable with output capacitors as low as 10 μ F. Small ceramic capacitors can be used without the necessary addition of ESR as is common with other regulators. Internal protection circuitry includes reverse battery protection, current limiting, thermal limiting and reverse current protection. The device is available in fixed output voltages of 1.5V, 1.8V, 2.5V, 3.3V and as an adjustable device with a 1.21V reference voltage. The LT1764A regulators are available in 5-lead TO-220 and DD packages.

LT, LTC and LT are registered trademarks of Linear Technology Corporation.

TYPICAL APPLICATION

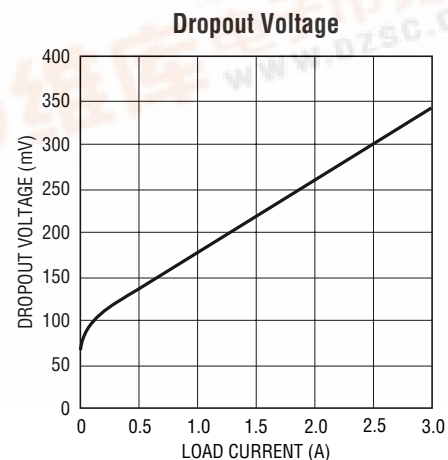
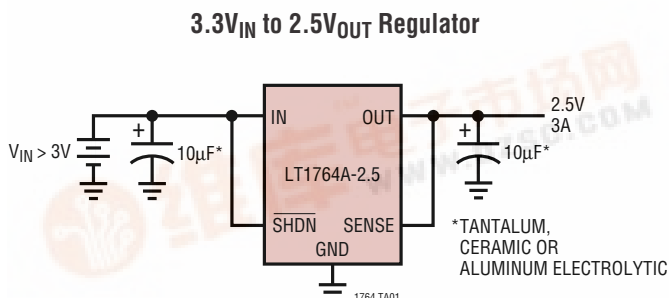

LT1764A Series

ABSOLUTE MAXIMUM RATINGS (Note 1)

IN Pin Voltage	±20V	SHDN Pin Voltage	±20V
OUT Pin Voltage	±20V	Output Short-Circuit Duration	Indefinite
Input to Output Differential Voltage (Note 12)	±20V	Operating Junction Temperature Range	–40°C to 125°C
SENSE Pin Voltage	±20V	Storage Temperature Range	–65°C to 150°C
ADJ Pin Voltage	±7V	Lead Temperature (Soldering, 10 sec)	300°C

PACKAGE/ORDER INFORMATION

<p>FRONT VIEW</p> <p>Q PACKAGE 5-LEAD PLASTIC DD</p> <p>*PIN 5 = SENSE FOR LT1764A-1.5/LT1764A1.8/ LT1764A-2.5/LT1764A-3.3 = ADJ FOR LT1764A</p> <p>T_{JMAX} = 150°C, θ_{JA} = 30°C/W</p>	<p>ORDER PART NUMBER</p> <p>LT1764AEQ LT1764AEQ-1.5 LT1764AEQ-1.8 LT1764AEQ-2.5 LT1764AEQ-3.3</p>	<p>FRONT VIEW</p> <p>T PACKAGE 5-LEAD PLASTIC TO-220</p> <p>*PIN 5 = SENSE FOR LT1764A-1.5/LT1764A-1.8/ LT1764A-2.5/LT1764A-3.3 = ADJ FOR LT1764A</p> <p>T_{JMAX} = 150°C, θ_{JA} = 50°C/W</p>	<p>ORDER PART NUMBER</p> <p>LT1764AET LT1764AET-1.5 LT1764AET-1.8 LT1764AET-2.5 LT1764AET-3.3</p>
-----------------------------------------------------------------------------------------------------------------------------------------------------------------------------------------------------------------------	-------------------------------------------------------------------------------------------------------------------	----------------------------------------------------------------------------------------------------------------------------------------------------------------------------------------------------------------------------	-------------------------------------------------------------------------------------------------------------------

Consult LTC Marketing for parts specified with wider operating temperature ranges.

ELECTRICAL CHARACTERISTICS

The ● denotes specifications which apply over the full operating temperature range, otherwise specifications are T_A = 25°C. (Note 2)

PARAMETER	CONDITIONS	MIN	TYP	MAX	UNITS
Minimum Input Voltage (Notes 3, 11)	I _{LOAD} = 0.5A		1.7		V
	I _{LOAD} = 1.5A		1.9		V
	I _{LOAD} = 3A ●		2.3	2.7	V
Regulated Output Voltage (Note 4)	LT1764A-1.5 V _{IN} = 2.21V, I _{LOAD} = 1mA 2.7V < V _{IN} < 20V, 1mA < I _{LOAD} < 3A ●	1.477	1.500	1.523	V
	LT1764A-1.8 V _{IN} = 2.3V, I _{LOAD} = 1mA 2.8V < V _{IN} < 20V, 1mA < I _{LOAD} < 3A ●	1.773	1.800	1.827	V
	LT1764A-2.5 V _{IN} = 3V, I _{LOAD} = 1mA 3.5V < V _{IN} < 20V, 1mA < I _{LOAD} < 3A ●	2.462	2.500	2.538	V
	LT1764A-3.3 V _{IN} = 3.8V, I _{LOAD} = 1mA 4.3V < V _{IN} < 20V, 1mA < I _{LOAD} < 3A ●	3.250	3.300	3.350	V
ADJ Pin Voltage (Notes 3, 4)	LT1764A V _{IN} = 2.21V, I _{LOAD} = 1mA 2.7V < V _{IN} < 20V, 1mA < I _{LOAD} < 3A ●	1.192	1.210	1.228	V
		●	1.168	1.210	1.246
Line Regulation	LT1764A-1.5 ΔV _{IN} = 2.21V to 20V, I _{LOAD} = 1mA ●		2.5	10	mV
	LT1764A-1.8 ΔV _{IN} = 2.3V to 20V, I _{LOAD} = 1mA ●		3	10	mV
	LT1764A-2.5 ΔV _{IN} = 3V to 20V, I _{LOAD} = 1mA ●		4	10	mV
	LT1764A-3.3 ΔV _{IN} = 3.8V to 20V, I _{LOAD} = 1mA ●		4.5	10	mV
	LT1764A (Note 3) ΔV _{IN} = 2.21V to 20V, I _{LOAD} = 1mA ●		2	10	mV

ELECTRICAL CHARACTERISTICS

The ● denotes specifications which apply over the full operating temperature range, otherwise specifications are $T_A = 25^\circ\text{C}$. (Note 2)

PARAMETER	CONDITIONS		MIN	TYP	MAX	UNITS
Load Regulation	LT1764A-1.5 $V_{IN} = 2.7\text{V}$, $\Delta I_{LOAD} = 1\text{mA}$ to 3A $V_{IN} = 2.7\text{V}$, $\Delta I_{LOAD} = 1\text{mA}$ to 3A	●		3	7 23	mV mV
	LT1764A-1.8 $V_{IN} = 2.8\text{V}$, $\Delta I_{LOAD} = 1\text{mA}$ to 3A $V_{IN} = 2.8\text{V}$, $\Delta I_{LOAD} = 1\text{mA}$ to 3A	●		4	8 25	mV mV
	LT1764A-2.5 $V_{IN} = 3.5\text{V}$, $\Delta I_{LOAD} = 1\text{mA}$ to 3A $V_{IN} = 3.5\text{V}$, $\Delta I_{LOAD} = 1\text{mA}$ to 3A	●		4	10 30	mV mV
	LT1764A-3.3 $V_{IN} = 4.3\text{V}$, $\Delta I_{LOAD} = 1\text{mA}$ to 3A $V_{IN} = 4.3\text{V}$, $\Delta I_{LOAD} = 1\text{mA}$ to 3A	●		4	12 40	mV mV
	LT1764A (Note 3) $V_{IN} = 2.7\text{V}$, $\Delta I_{LOAD} = 1\text{mA}$ to 3A $V_{IN} = 2.7\text{V}$, $\Delta I_{LOAD} = 1\text{mA}$ to 3A	●		2	5 20	mV mV
Dropout Voltage $V_{IN} = V_{OUT(NOMINAL)}$ (Notes 5, 6, 11)	$I_{LOAD} = 1\text{mA}$ $I_{LOAD} = 1\text{mA}$	●		0.02	0.05 0.10	V V
	$I_{LOAD} = 100\text{mA}$ $I_{LOAD} = 100\text{mA}$	●		0.07	0.13 0.18	V V
	$I_{LOAD} = 500\text{mA}$ $I_{LOAD} = 500\text{mA}$	●		0.14	0.20 0.27	V V
	$I_{LOAD} = 1.5\text{A}$ $I_{LOAD} = 1.5\text{A}$	●		0.25	0.33 0.40	V V
	$I_{LOAD} = 3\text{A}$ $I_{LOAD} = 3\text{A}$	●		0.34	0.45 0.66	V V
GND Pin Current $V_{IN} = V_{OUT(NOMINAL)} + 1\text{V}$ (Notes 5, 7)	$I_{LOAD} = 0\text{mA}$	●		1	1.5	mA
	$I_{LOAD} = 1\text{mA}$	●		1.1	1.6	mA
	$I_{LOAD} = 100\text{mA}$	●		3.5	5	mA
	$I_{LOAD} = 500\text{mA}$	●		11	18	mA
	$I_{LOAD} = 1.5\text{A}$	●		40	75	mA
	$I_{LOAD} = 3\text{A}$	●		120	200	mA
Output Voltage Noise	$C_{OUT} = 10\mu\text{F}$, $I_{LOAD} = 3\text{A}$, $\text{BW} = 10\text{Hz}$ to 100kHz			40		μV_{RMS}
ADJ Pin Bias Current	(Notes 3, 8)			3	10	μA
Shutdown Threshold	$V_{OUT} = \text{Off to On}$	●		0.9	2	V
	$V_{OUT} = \text{On to Off}$	●	0.25	0.75		V
SHDN Pin Current (Note 9)	$V_{SHDN} = 0\text{V}$			0.01	1	μA
	$V_{SHDN} = 20\text{V}$			7	30	μA
Quiescent Current in Shutdown	$V_{IN} = 6\text{V}$, $V_{SHDN} = 0\text{V}$			0.01	1	μA
Ripple Rejection	$V_{IN} - V_{OUT} = 1.5\text{V}$ (Avg), $V_{RIPPLE} = 0.5\text{V}_{P-P}$, $f_{RIPPLE} = 120\text{Hz}$, $I_{LOAD} = 1.5\text{A}$		55	63		dB
Current Limit	$V_{IN} = 7\text{V}$, $V_{OUT} = 0\text{V}$			4		A
	LT1764A-1.8, LT1764A-2.5, LT1764A-3.3; $V_{IN} = V_{OUT(NOMINAL)} + 1\text{V}$, $\Delta V_{OUT} = -0.1\text{V}$	●	3.1			A
	LT1764A, LT1764A-1.5; $V_{IN} = 2.7\text{V}$, $\Delta V_{OUT} = -0.1\text{V}$	●	3.1			A

LT1764A Series

ELECTRICAL CHARACTERISTICS

The ● denotes specifications which apply over the full operating temperature range, otherwise specifications are $T_A = 25^\circ\text{C}$. (Note 2)

PARAMETER	CONDITIONS	MIN	TYP	MAX	UNITS
Input Reverse Leakage Current	$V_{IN} = -20\text{V}, V_{OUT} = 0\text{V}$	●		1	mA
Reverse Output Current (Note 10)	LT1764A-1.5V $V_{OUT} = 1.5\text{V}, V_{IN} < 1.5\text{V}$ LT1764A-1.8V $V_{OUT} = 1.8\text{V}, V_{IN} < 1.8\text{V}$ LT1764A-2.5V $V_{OUT} = 2.5\text{V}, V_{IN} < 2.5\text{V}$ LT1764A-3.3V $V_{OUT} = 3.3\text{V}, V_{IN} < 3.3\text{V}$ LT1764A (Note 3) $V_{OUT} = 1.21\text{V}, V_{IN} < 1.21\text{V}$		600	1200	μA
			600	1200	μA
			600	1200	μA
			600	1200	μA
			300	600	μA

Note 1: Absolute Maximum Ratings are those values beyond which the life of a device may be impaired.

Note 2: The LT1764A regulators are tested and specified under pulse load conditions such that $T_J \approx T_A$. The LT1764A is 100% tested at $T_A = 25^\circ\text{C}$. Performance at -40°C and 125°C is assured by design, characterization and correlation with statistical process controls.

Note 3: The LT1764A (adjustable version) is tested and specified for these conditions with the ADJ pin connected to the OUT pin.

Note 4: Operating conditions are limited by maximum junction temperature. The regulated output voltage specification will not apply for all possible combinations of input voltage and output current. When operating at maximum input voltage, the output current range must be limited. When operating at maximum output current, the input voltage range must be limited.

Note 5: To satisfy requirements for minimum input voltage, the LT1764A (adjustable version) is tested and specified for these conditions with an external resistor divider (two 4.12k resistors) for an output voltage of 2.42V. The external resistor divider will add a 300 μA DC load on the output.

Note 6: Dropout voltage is the minimum input to output voltage differential needed to maintain regulation at a specified output current. In dropout, the output voltage will be equal to: $V_{IN} - V_{DROPOUT}$.

Note 7: GND pin current is tested with $V_{IN} = V_{OUT(\text{NOMINAL})} + 1\text{V}$ or $V_{IN} = 2.7\text{V}$ (whichever is greater) and a current source load. The GND pin current will decrease at higher input voltages.

Note 8: ADJ pin bias current flows into the ADJ pin.

Note 9: SHDN pin current flows into the SHDN pin.

Note 10: Reverse output current is tested with the IN pin grounded and the OUT pin forced to the rated output voltage. This current flows into the OUT pin and out the GND pin.

Note 11: For the LT1764A, LT1764A-1.5 and LT1764A-1.8 dropout voltage will be limited by the minimum input voltage specification under some output voltage/load conditions.

Note 12: All combinations of absolute maximum input voltage and absolute maximum output voltage cannot be achieved. The absolute maximum differential from input to output is $\pm 20\text{V}$. For example, with $V_{IN} = 20\text{V}$, V_{OUT} cannot be pulled below ground.

TYPICAL PERFORMANCE CHARACTERISTICS

Typical Dropout Voltage

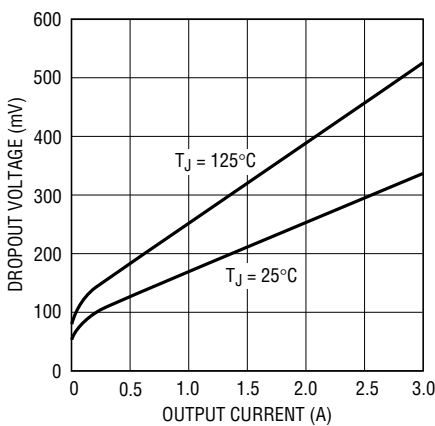

1764 G01

Guaranteed Dropout Voltage

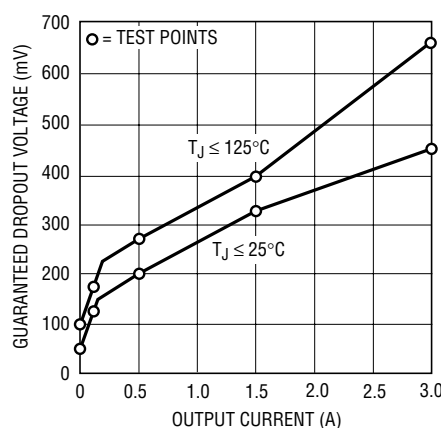

1764 G02

Dropout Voltage

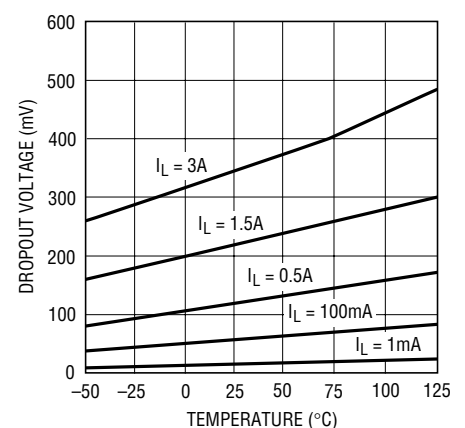

1764 G03

TYPICAL PERFORMANCE CHARACTERISTICS

Quiescent Current

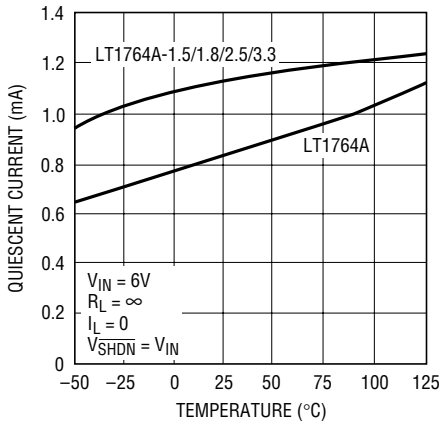

1764 G04

LT1764A-1.5 Output Voltage

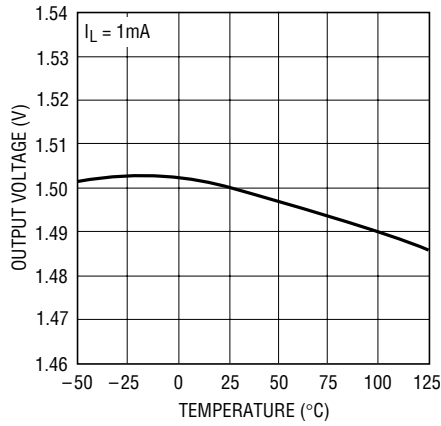

1764A G40

LT1764A-1.8 Output Voltage

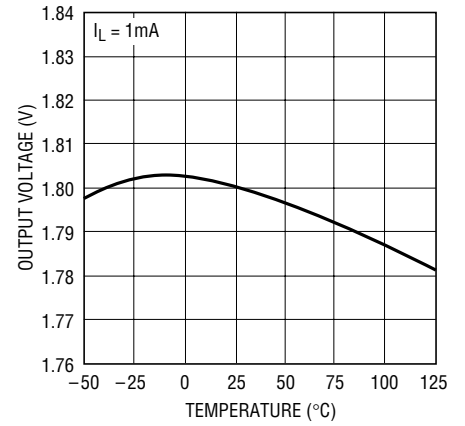

1756 G05

LT1764A-2.5 Output Voltage

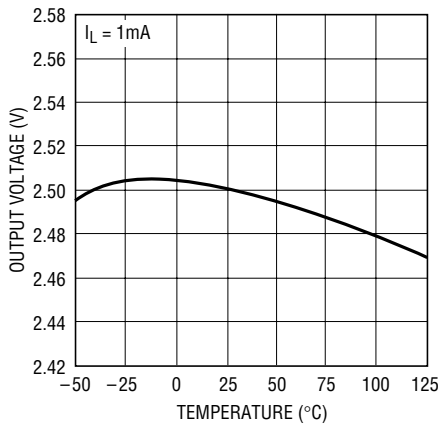

1756 G06

LT1764A-3.3 Output Voltage

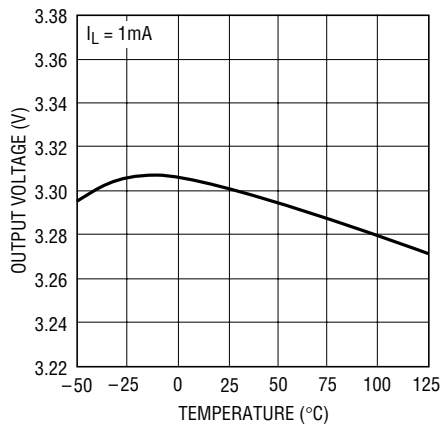

1756 G07

LT1764A ADJ Pin Voltage

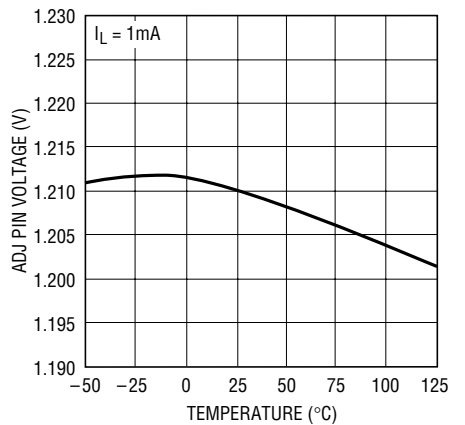

1756 G08

LT1764A-1.5 Quiescent Current

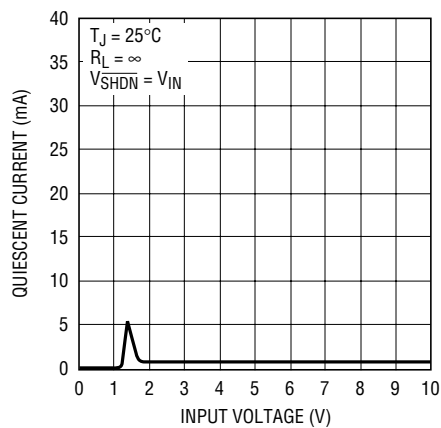

1764 G41

LT1764A-1.8 Quiescent Current

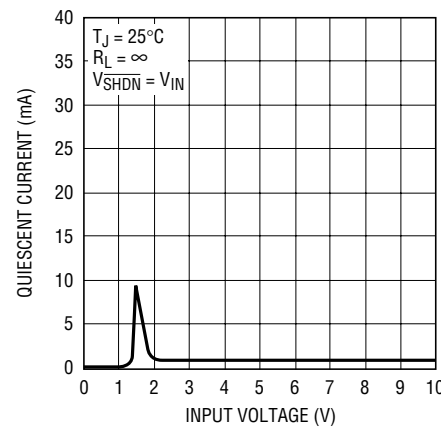

1764 G09

LT1764A-2.5 Quiescent Current

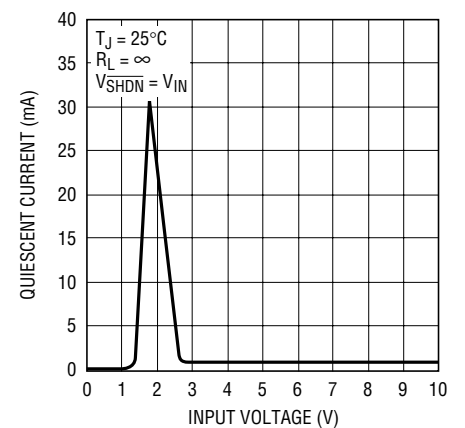

1764 G10

LT1764A Series

TYPICAL PERFORMANCE CHARACTERISTICS

LT1764A-3.3 Quiescent Current

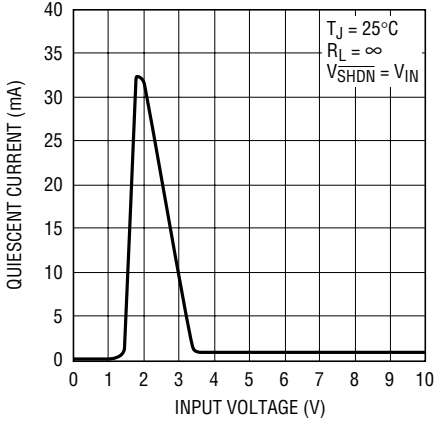

1764 G11

LT1764A Quiescent Current

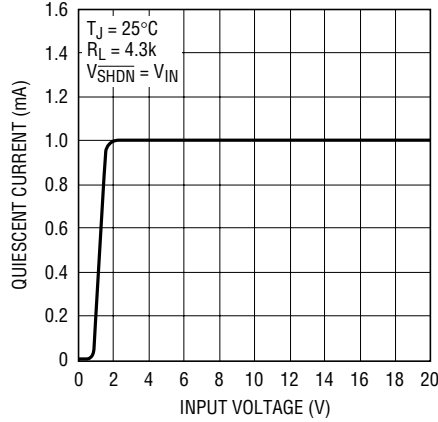

1764 G12

LT1764A-1.5 GND Pin Current

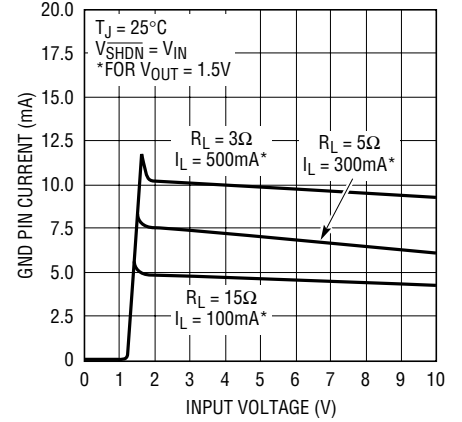

1764 G42

LT1764A-1.8 GND Pin Current

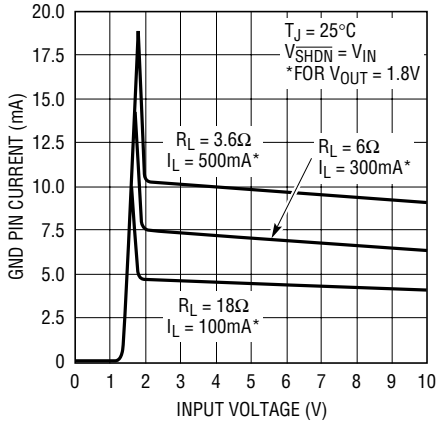

1764 G13

LT1764A-2.5 GND Pin Current

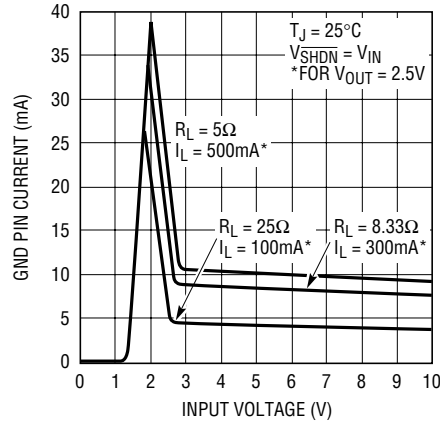

1764 G14

LT1764A-3.3 GND Pin Current

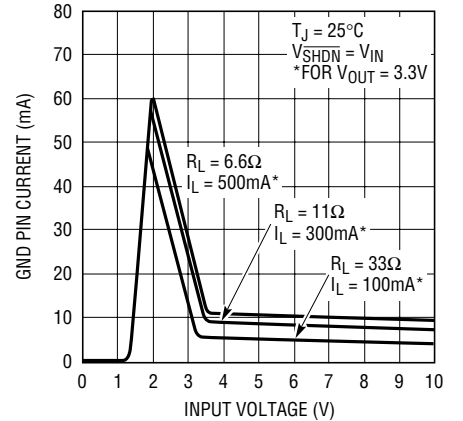

1764 G15

LT1764A GND Pin Current

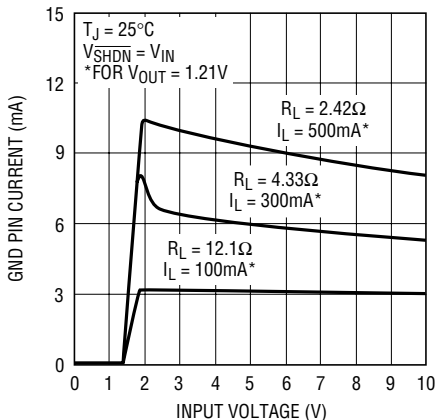

1764 G16

LT1764A-1.5 GND Pin Current

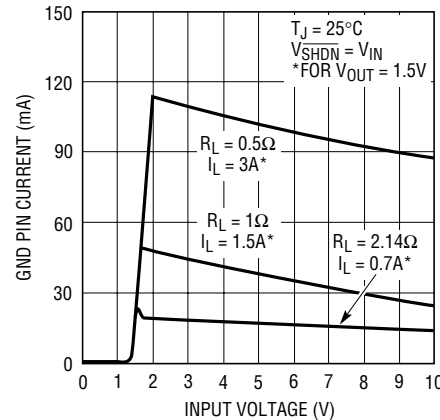

1764 G43

LT1764A-1.8 GND Pin Current

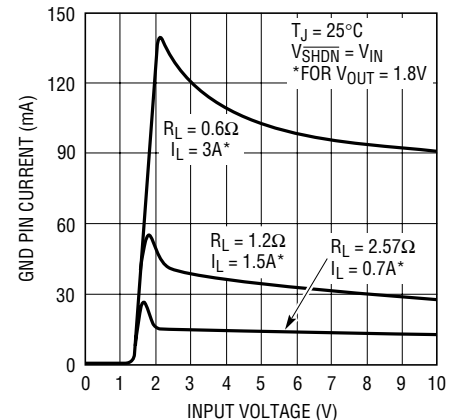

1764 G17

TYPICAL PERFORMANCE CHARACTERISTICS

LT1764A-2.5V GND Pin Current

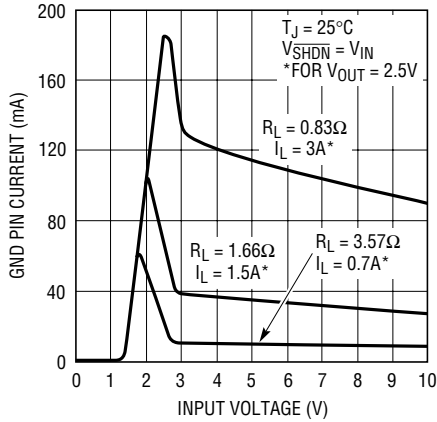

1764 G18

LT1764A-3.3V GND Pin Current

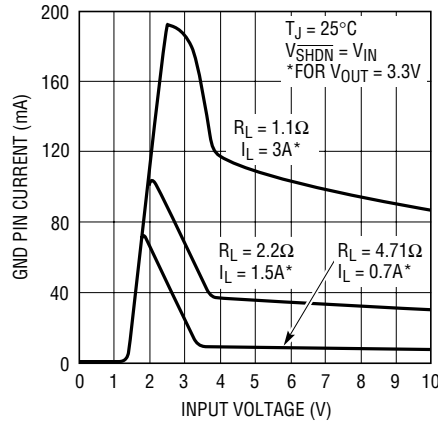

1764 G19

LT1764A GND Pin Current

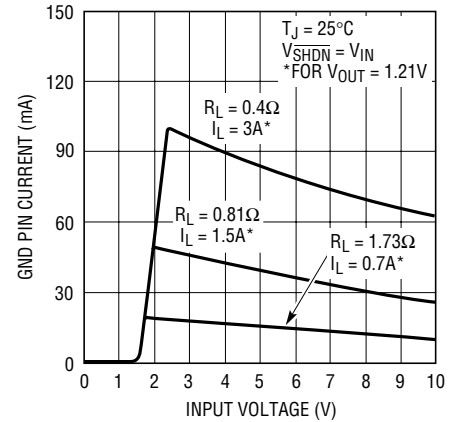

1764 G20

GND Pin Current vs I_{LOAD}

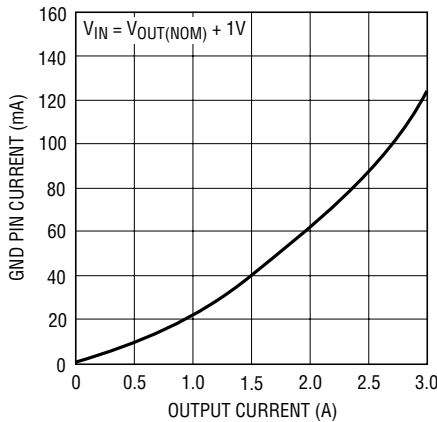

1764 G21

SHDN Pin Threshold (On-to-Off)

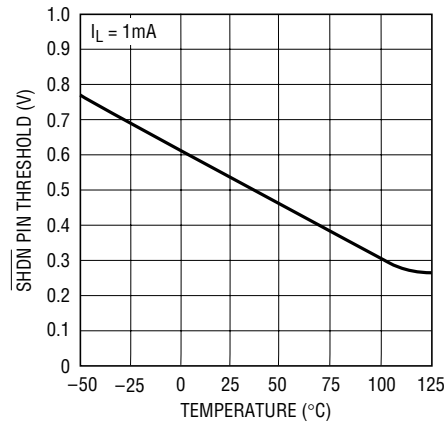

1764 G22

SHDN Pin Threshold (Off-to-On)

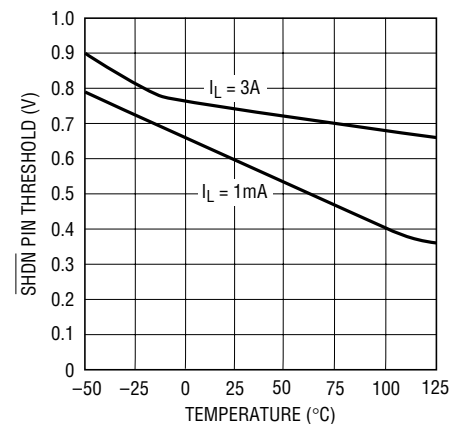

1764 G23

SHDN Pin Input Current

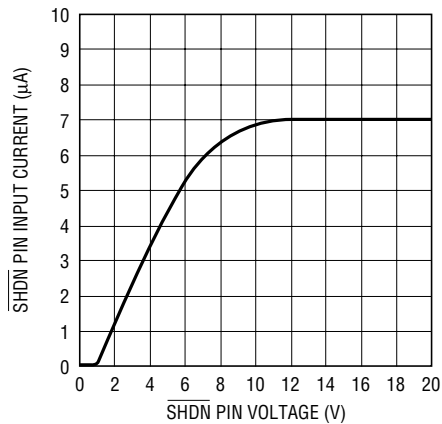

1764 G24

SHDN Pin Input Current

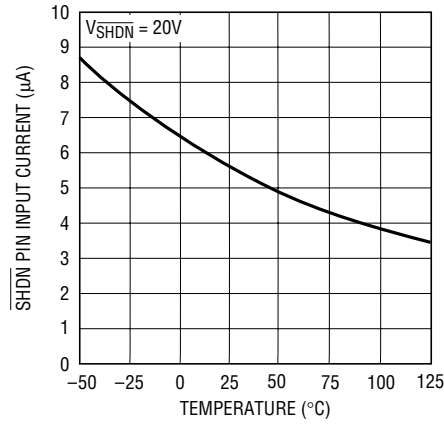

1764 G25

ADJ Pin Bias Current

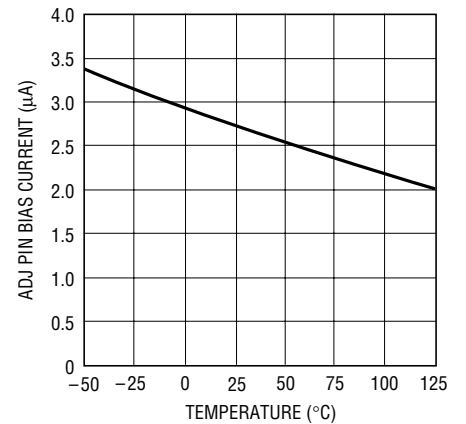

1756 G26

LT1764A Series

TYPICAL PERFORMANCE CHARACTERISTICS

Current Limit

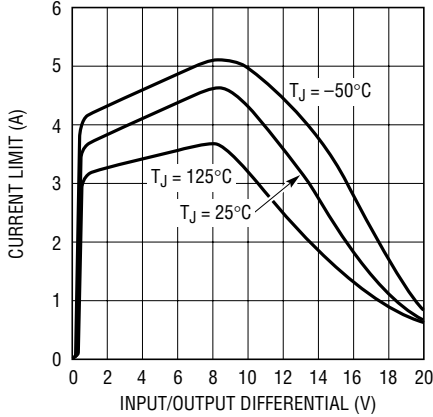

1764 G27

Current Limit

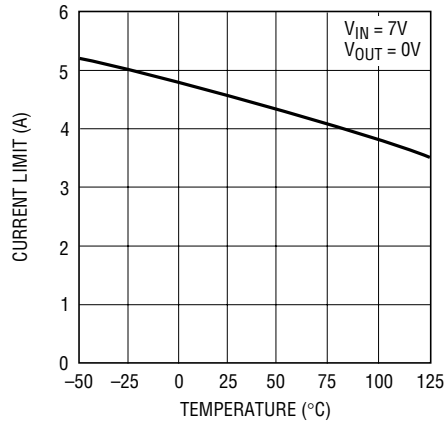

1764 G28

Reverse Output Current

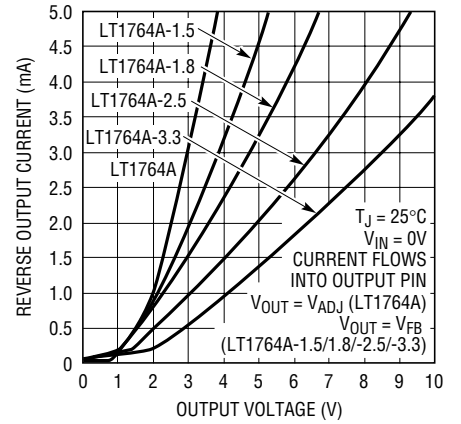

1764 G29

Reverse Output Current

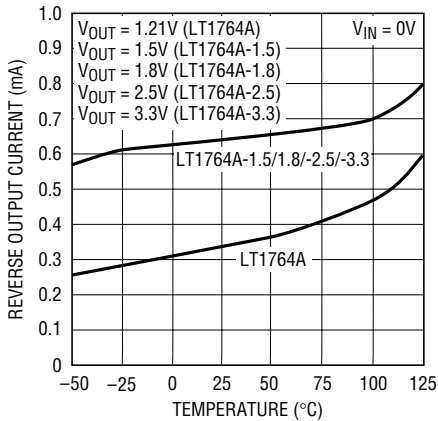

1764 G30

Ripple Rejection

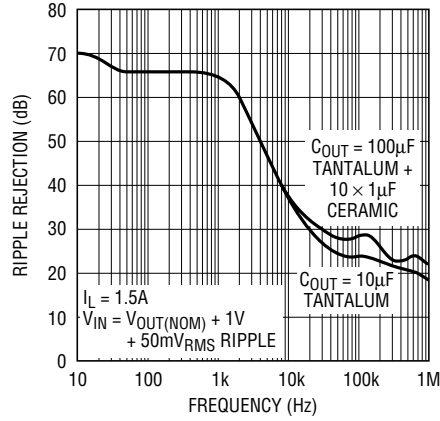

1764 G31

Ripple Rejection

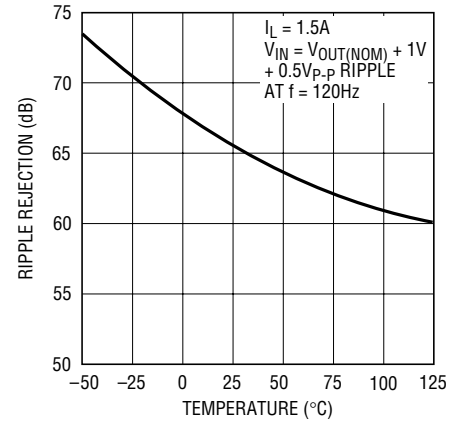

1764 G32

LT1764A Minimum Input Voltage

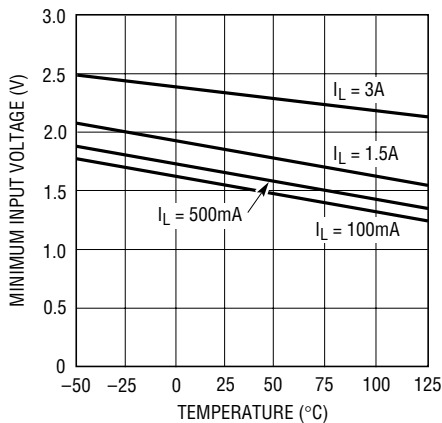

1764 G33

Load Regulation

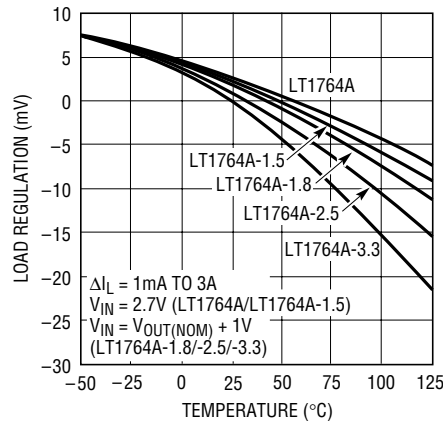

1764 G34

Output Noise Spectral Density

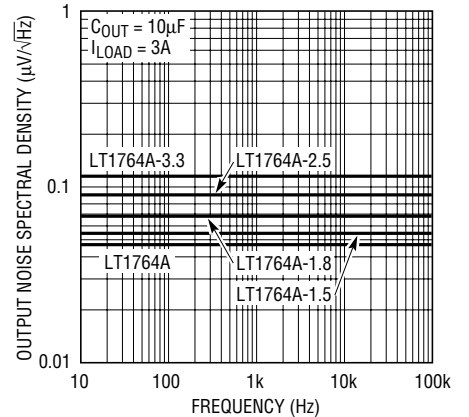

1764 G35

TYPICAL PERFORMANCE CHARACTERISTICS

RMS Output Noise vs Load Current (10Hz to 100kHz)

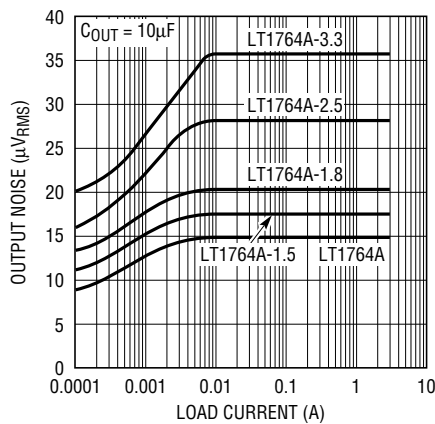

1764 G36

LT1764A-3.3 10Hz to 100kHz Output Noise

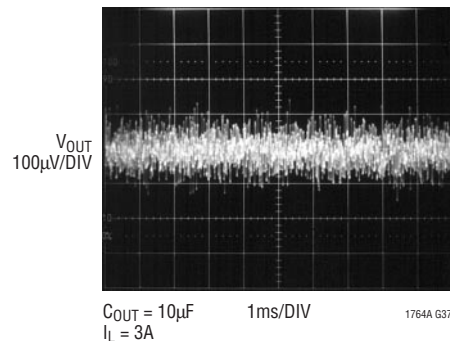

LT1764A-3.3 Transient Response

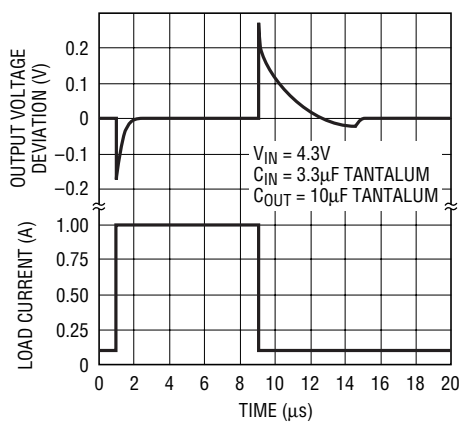

1764 G38

LT1764A-3.3 Transient Response

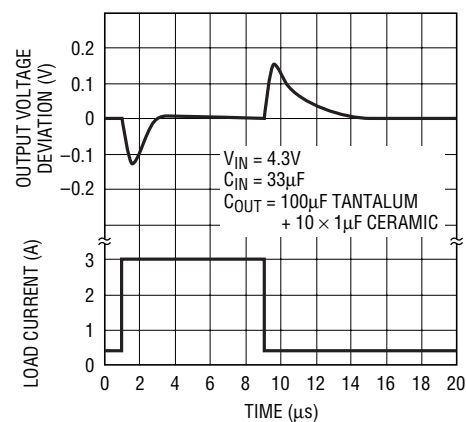

1764 G39

PIN FUNCTIONS

SHDN (Pin 1): Shutdown. The $\overline{\text{SHDN}}$ pin is used to put the LT1764A regulators into a low power shutdown state. The output will be off when the $\overline{\text{SHDN}}$ pin is pulled low. The $\overline{\text{SHDN}}$ pin can be driven either by 5V logic or open-collector logic with a pull-up resistor. The pull-up resistor is required to supply the pull-up current of the open-collector gate, normally several microamperes, and the $\overline{\text{SHDN}}$ pin current, typically 7 μA . If unused, the $\overline{\text{SHDN}}$ pin must be connected to V_{IN} . The device will be in the low power shutdown state if the $\overline{\text{SHDN}}$ pin is not connected.

IN (Pin 2): Input. Power is supplied to the device through the IN pin. A bypass capacitor is required on this pin if the

device is more than six inches away from the main input filter capacitor. In general, the output impedance of a battery rises with frequency, so it is advisable to include a bypass capacitor in battery-powered circuits. A bypass capacitor in the range of 1 μF to 10 μF is sufficient. The LT1764A regulators are designed to withstand reverse voltages on the IN pin with respect to ground and the OUT pin. In the case of a reverse input, which can happen if a battery is plugged in backwards, the device will act as if there is a diode in series with its input. There will be no reverse current flow into the regulator and no reverse voltage will appear at the load. The device will protect both itself and the load.

LT1764A Series

PIN FUNCTIONS

GND (Pin 3): Ground.

OUT (Pin 4): Output. The output supplies power to the load. A minimum output capacitor of 10 μ F is required to prevent oscillations. Larger output capacitors will be required for applications with large transient loads to limit peak voltage transients. See the Applications Information section for more information on output capacitance and reverse output characteristics.

SENSE (Pin 5): Sense. For fixed voltage versions of the LT1764A (LT1764A-1.5/LT1764A-1.8/LT1764A-2.5/LT1764A-3.3), the SENSE pin is the input to the error amplifier. Optimum regulation will be obtained at the point where the SENSE pin is connected to the OUT pin of the regulator. In critical applications, small voltage drops are caused by the resistance (R_P) of PC traces between the regulator and the load. These may be eliminated by connecting the SENSE pin to the output at the load as shown in Figure 1 (Kelvin Sense Connection). Note that the voltage drop across the external PC traces will add to the

dropout voltage of the regulator. The SENSE pin bias current is 600 μ A at the nominal rated output voltage. The SENSE pin can be pulled below ground (as in a dual supply system where the regulator load is returned to a negative supply) and still allow the device to start and operate.

ADJ (Pin 5): Adjust. For the adjustable LT1764A, this is the input to the error amplifier. This pin is internally clamped to $\pm 7V$. It has a bias current of 3 μ A which flows into the pin. The ADJ pin voltage is 1.21V referenced to ground and the output voltage range is 1.21V to 20V.

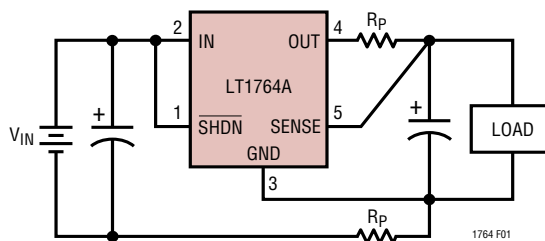

Figure 1. Kelvin Sense Connection

APPLICATIONS INFORMATION

The LT1764A series are 3A low dropout regulators optimized for fast transient response. The devices are capable of supplying 3A at a dropout voltage of 340mV. The low operating quiescent current (1mA) drops to less than 1 μ A in shutdown. In addition to the low quiescent current, the LT1764A regulators incorporate several protection features which make them ideal for use in battery-powered systems. The devices are protected against both reverse input and reverse output voltages. In battery backup applications where the output can be held up by a backup battery when the input is pulled to ground, the LT1764A-X acts like it has a diode in series with its output and prevents reverse current flow. Additionally, in dual supply applications where the regulator load is returned to a negative supply, the output can be pulled below ground by as much as 20V and still allow the device to start and operate.

Adjustable Operation

The adjustable version of the LT1764A has an output voltage range of 1.21V to 20V. The output voltage is set by

the ratio of two external resistors as shown in Figure 2. The device serves the output to maintain the voltage at the ADJ pin at 1.21V referenced to ground. The current in R1 is then equal to 1.21V/R1 and the current in R2 is the current in R1 plus the ADJ pin bias current. The ADJ pin bias current, 3 μ A at 25 $^{\circ}$ C, flows through R2 into the ADJ pin. The output voltage can be calculated using the formula in Figure 2. The value of R1 should be less than 4.17k to minimize errors in the output voltage caused by the ADJ pin bias current. Note that in shutdown the output is turned off and the divider current will be zero.

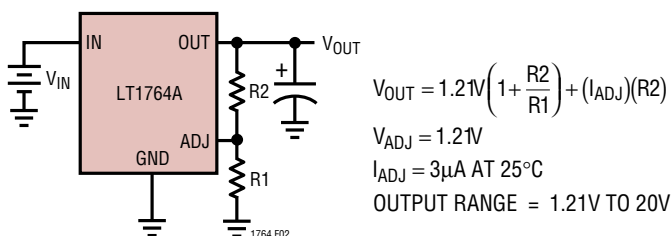

Figure 2. Adjustable Operation

APPLICATIONS INFORMATION

The adjustable device is tested and specified with the ADJ pin tied to the OUT pin for an output voltage of 1.21V. Specifications for output voltages greater than 1.21V will be proportional to the ratio of the desired output voltage to 1.21V: $V_{OUT}/1.21V$. For example, load regulation for an output current change of 1mA to 3A is $-3mV$ typical at $V_{OUT} = 1.21V$. At $V_{OUT} = 5V$, load regulation is:

$$(5V/1.21V)(-3mV) = -12.4mV$$

Output Capacitance and Transient Response

The LT1764A regulators are designed to be stable with a wide range of output capacitors. The ESR of the output capacitor affects stability, most notably with small capacitors. A minimum output capacitor of $10\mu F$ with an ESR of 3Ω or less is recommended to prevent oscillations. Larger values of output capacitance can decrease the peak deviations and provide improved transient response for larger load current changes. Bypass capacitors, used to decouple individual components powered by the LT1764A-X, will increase the effective output capacitor value.

Extra consideration must be given to the use of ceramic capacitors. Ceramic capacitors are manufactured with a variety of dielectrics, each with different behavior over temperature and applied voltage. The most common dielectrics used are Z5U, Y5V, X5R and X7R. The Z5U and Y5V dielectrics are good for providing high capacitances in a small package, but exhibit strong voltage and temperature coefficients as shown in Figures 3 and 4. When used with a 5V regulator, a $10\mu F$ Y5V capacitor can exhibit

an effective value as low as $1\mu F$ to $2\mu F$ over the operating temperature range. The X5R and X7R dielectrics result in more stable characteristics and are more suitable for use as the output capacitor. The X7R type has better stability across temperature, while the X5R is less expensive and is available in higher values.

Voltage and temperature coefficients are not the only sources of problems. Some ceramic capacitors have a piezoelectric response. A piezoelectric device generates voltage across its terminals due to mechanical stress, similar to the way a piezoelectric accelerometer or microphone works. For a ceramic capacitor the stress can be induced by vibrations in the system or thermal transients.

Overload Recovery

Like many IC power regulators, the LT1764A-X has safe operating area protection. The safe area protection decreases the current limit as input-to-output voltage increases and keeps the power transistor inside a safe operating region for all values of input-to-output voltage. The protection is designed to provide some output current at all values of input-to-output voltage up to the device breakdown.

When power is first turned on, as the input voltage rises, the output follows the input, allowing the regulator to start up into very heavy loads. During the start-up, as the input voltage is rising, the input-to-output voltage differential is small, allowing the regulator to supply large output currents. With a high input voltage, a problem can occur

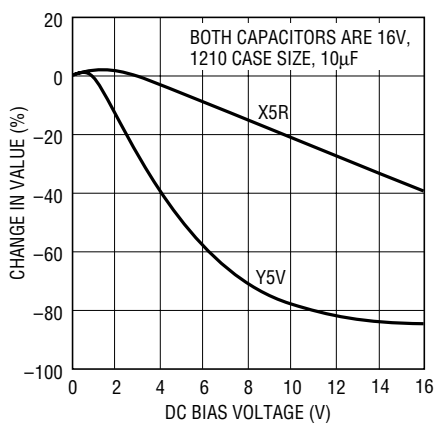

Figure 3. Ceramic Capacitor DC Bias Characteristics

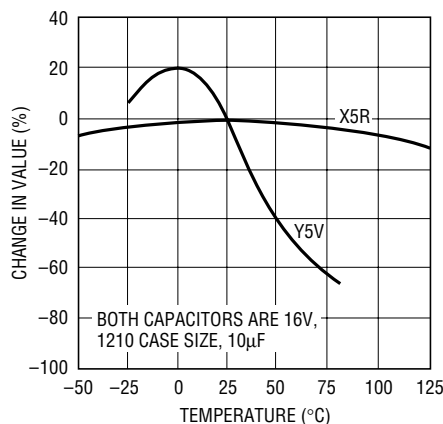

Figure 4. Ceramic Capacitor Temperature Characteristics

LT1764A Series

APPLICATIONS INFORMATION

wherein removal of an output short will not allow the output voltage to recover. Other regulators, such as the LT1085, also exhibit this phenomenon, so it is not unique to the LT1764A series.

The problem occurs with a heavy output load when the input voltage is high and the output voltage is low. Common situations are immediately after the removal of a short circuit or when the SHDN pin is pulled high after the input voltage has already been turned on. The load line for such a load may intersect the output current curve at two points. If this happens, there are two stable output operating points for the regulator. With this double intersection, the input power supply may need to be cycled down to zero and brought up again to make the output recover.

Output Voltage Noise

The LT1764A regulators have been designed to provide low output voltage noise over the 10Hz to 100kHz bandwidth while operating at full load. Output voltage noise is typically $50\text{nV}\sqrt{\text{Hz}}$ over this frequency bandwidth for the LT1764A (adjustable version). For higher output voltages (generated by using a resistor divider), the output voltage noise will be gained up accordingly. This results in RMS noise over the 10Hz to 100kHz bandwidth of $15\mu\text{V}_{\text{RMS}}$ for the LT1764A increasing to $37\mu\text{V}_{\text{RMS}}$ for the LT1764A-3.3.

Higher values of output voltage noise may be measured when care is not exercised with regards to circuit layout and testing. Crosstalk from nearby traces can induce unwanted noise onto the output of the LT1764A-X. Power supply ripple rejection must also be considered; the LT1764A regulators do not have unlimited power supply rejection and will pass a small portion of the input noise through to the output.

Thermal Considerations

The power handling capability of the device is limited by the maximum rated junction temperature (125°C). The power dissipated by the device is made up of two components:

1. Output current multiplied by the input/output voltage differential: $(I_{\text{OUT}})(V_{\text{IN}} - V_{\text{OUT}})$, and

2. GND pin current multiplied by the input voltage: $(I_{\text{GND}})(V_{\text{IN}})$.

The GND pin current can be found using the GND Pin Current curves in the Typical Performance Characteristics. Power dissipation will be equal to the sum of the two components listed above.

The LT1764A series regulators have internal thermal limiting designed to protect the device during overload conditions. For continuous normal conditions, the maximum junction temperature rating of 125°C must not be exceeded. It is important to give careful consideration to all sources of thermal resistance from junction to ambient. Additional heat sources mounted nearby must also be considered.

For surface mount devices, heat sinking is accomplished by using the heat spreading capabilities of the PC board and its copper traces. Surface mount heatsinks and plated through-holes can also be used to spread the heat generated by power devices.

The following table lists thermal resistance for several different board sizes and copper areas. All measurements were taken in still air on 1/16" FR-4 board with one ounce copper.

Table 1. Q Package, 5-Lead DD

COPPER AREA		BOARD AREA	THERMAL RESISTANCE (JUNCTION-TO-AMBIENT)
TOPSIDE*	BACKSIDE		
2500mm ²	2500mm ²	2500mm ²	23°C/W
1000mm ²	2500mm ²	2500mm ²	25°C/W
125mm ²	2500mm ²	2500mm ²	33°C/W

*Device is mounted on topside.

T Package, 5-Lead TO-220

Thermal Resistance (Junction-to-Case) = 2.5°C/W

Calculating Junction Temperature

Example: Given an output voltage of 3.3V, an input voltage range of 4V to 6V, an output current range of 0mA to 500mA and a maximum ambient temperature of 50°C , what will the maximum junction temperature be?

The power dissipated by the device will be equal to:

$$I_{\text{OUT(MAX)}}(V_{\text{IN(MAX)}} - V_{\text{OUT}}) + I_{\text{GND}}(V_{\text{IN(MAX)}})$$

APPLICATIONS INFORMATION

where,

$$I_{OUT(MAX)} = 500\text{mA}$$

$$V_{IN(MAX)} = 6\text{V}$$

$$I_{GND} \text{ at } (I_{OUT} = 500\text{mA}, V_{IN} = 6\text{V}) = 10\text{mA}$$

So,

$$P = 500\text{mA}(6\text{V} - 3.3\text{V}) + 10\text{mA}(6\text{V}) = 1.41\text{W}$$

Using a DD package, the thermal resistance will be in the range of 23°C/W to 33°C/W depending on the copper area. So the junction temperature rise above ambient will be approximately equal to:

$$1.41\text{W}(28^\circ\text{C/W}) = 39.5^\circ\text{C}$$

The maximum junction temperature will then be equal to the maximum junction temperature rise above ambient plus the maximum ambient temperature or:

$$T_{JMAX} = 50^\circ\text{C} + 39.5^\circ\text{C} = 89.5^\circ\text{C}$$

Protection Features

The LT1764A regulators incorporate several protection features which make them ideal for use in battery-powered circuits. In addition to the normal protection features associated with monolithic regulators, such as current limiting and thermal limiting, the devices are protected against reverse input voltages, reverse output voltages and reverse voltages from output to input.

Current limit protection and thermal overload protection are intended to protect the device against current overload conditions at the output of the device. For normal operation, the junction temperature should not exceed 125°C.

The input of the device will withstand reverse voltages of 20V. Current flow into the device will be limited to less than 1mA and no negative voltage will appear at the output. The device will protect both itself and the load. This provides protection against batteries which can be plugged in backward.

The output of the LT1764A-X can be pulled below ground without damaging the device. If the input is left open circuit or grounded, the output can be pulled below ground by 20V. For fixed voltage versions, the output will act like a large resistor, typically 5k or higher, limiting current flow to typically less than 600µA. For adjustable versions, the

output will act like an open circuit; no current will flow out of the pin. If the input is powered by a voltage source, the output will source the short-circuit current of the device and will protect itself by thermal limiting. In this case, grounding the SHDN pin will turn off the device and stop the output from sourcing the short-circuit current.

The ADJ pin of the adjustable device can be pulled above or below ground by as much as 7V without damaging the device. If the input is left open circuit or grounded, the ADJ pin will act like an open circuit when pulled below ground and like a large resistor (typically 5k) in series with a diode when pulled above ground.

In situations where the ADJ pin is connected to a resistor divider that would pull the ADJ pin above its 7V clamp voltage if the output is pulled high, the ADJ pin input current must be limited to less than 5mA. For example, a resistor divider is used to provide a regulated 1.5V output from the 1.21V reference when the output is forced to 20V. The top resistor of the resistor divider must be chosen to limit the current into the ADJ pin to less than 5mA when the ADJ pin is at 7V. The 13V difference between OUT and ADJ pins divided by the 5mA maximum current into the ADJ pin yields a minimum top resistor value of 2.6k.

In circuits where a backup battery is required, several different input/output conditions can occur. The output voltage may be held up while the input is either pulled to ground, pulled to some intermediate voltage, or is left open circuit. Current flow back into the output will follow the curve shown in Figure 5.

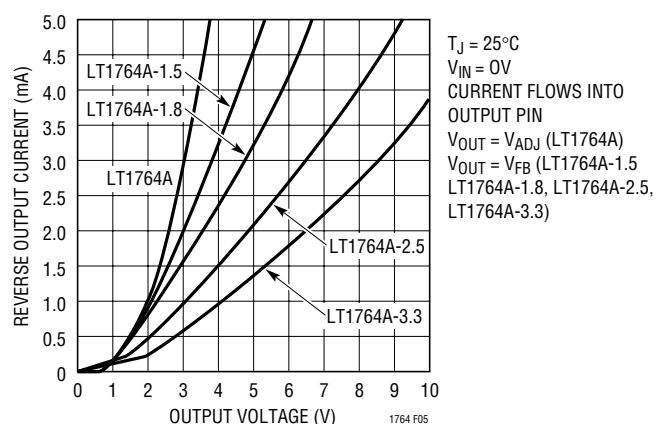

Figure 5. Reverse Output Current

LT1764A Series

APPLICATIONS INFORMATION

When the IN pin of the LT1764A-X is forced below the OUT pin or the OUT pin is pulled above the IN pin, input current will typically drop to less than $2\mu\text{A}$. This can happen if the input of the device is connected to a discharged (low

voltage) battery and the output is held up by either a backup battery or a second regulator circuit. The state of the SHDN pin will have no effect on the reverse output current when the output is pulled above the input.

TYPICAL APPLICATIONS

SCR Preregulator Provides Efficiency Over Line Variations

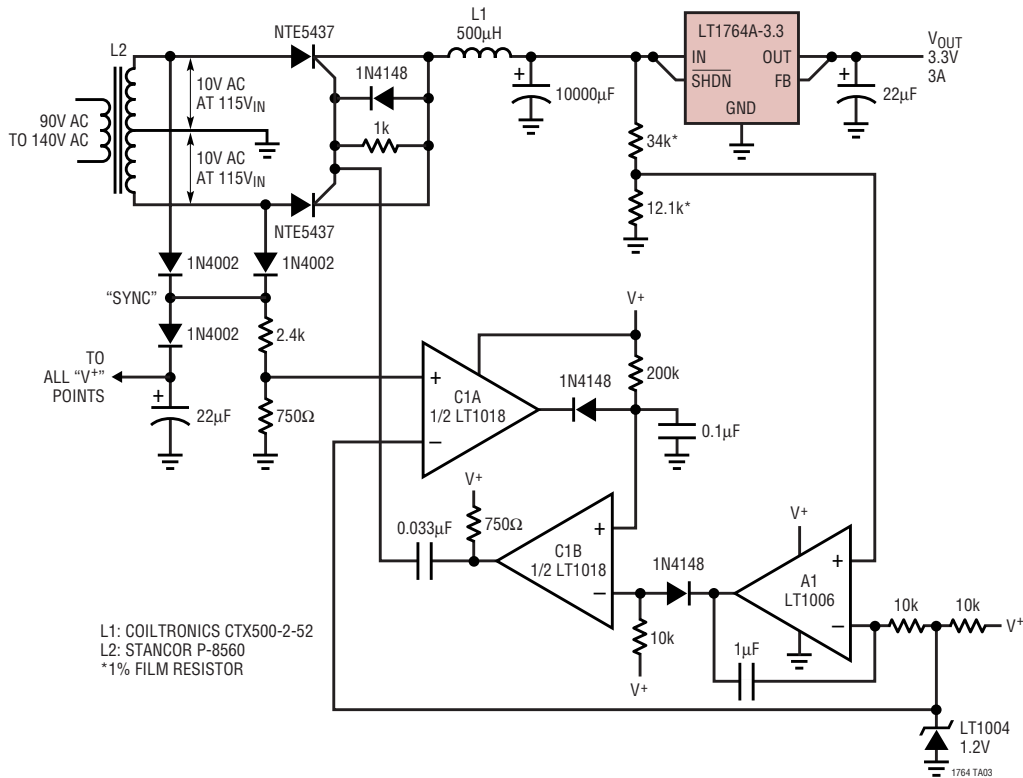

Adjustable Current Source

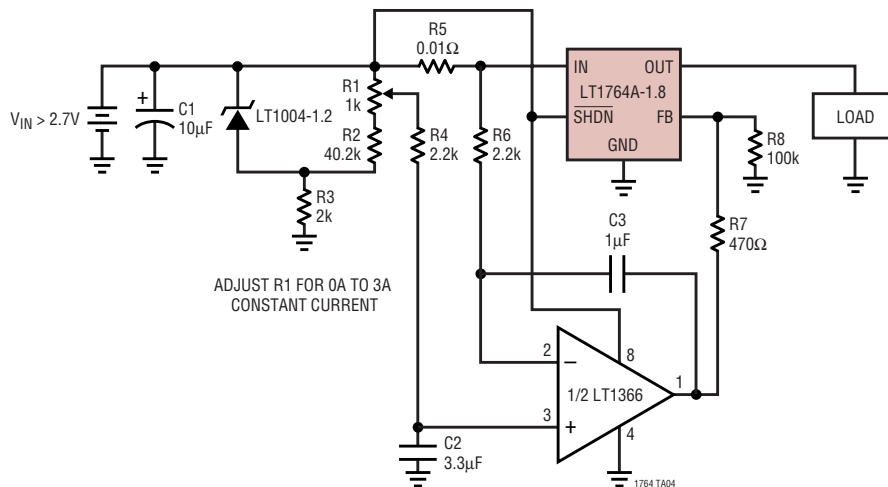

PACKAGE DESCRIPTION

Q Package
5-Lead Plastic DD Pak
 (Reference LTC DWG # 05-08-1461)

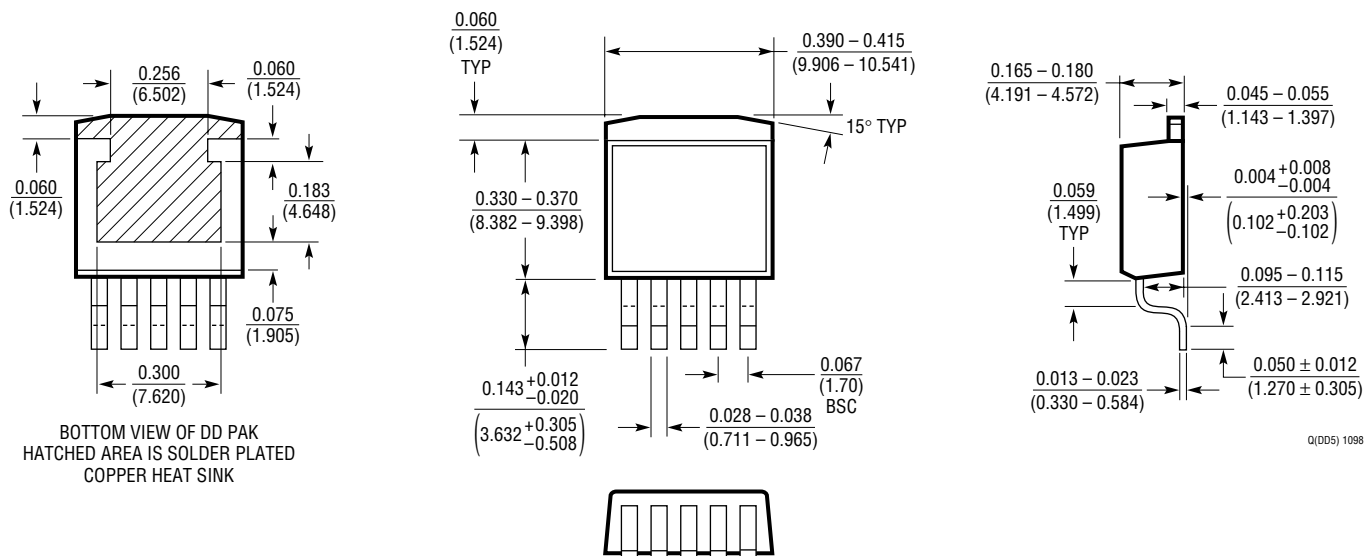

T Package
5-Lead Plastic TO-220 (Standard)
 (Reference LTC DWG # 05-08-1421)

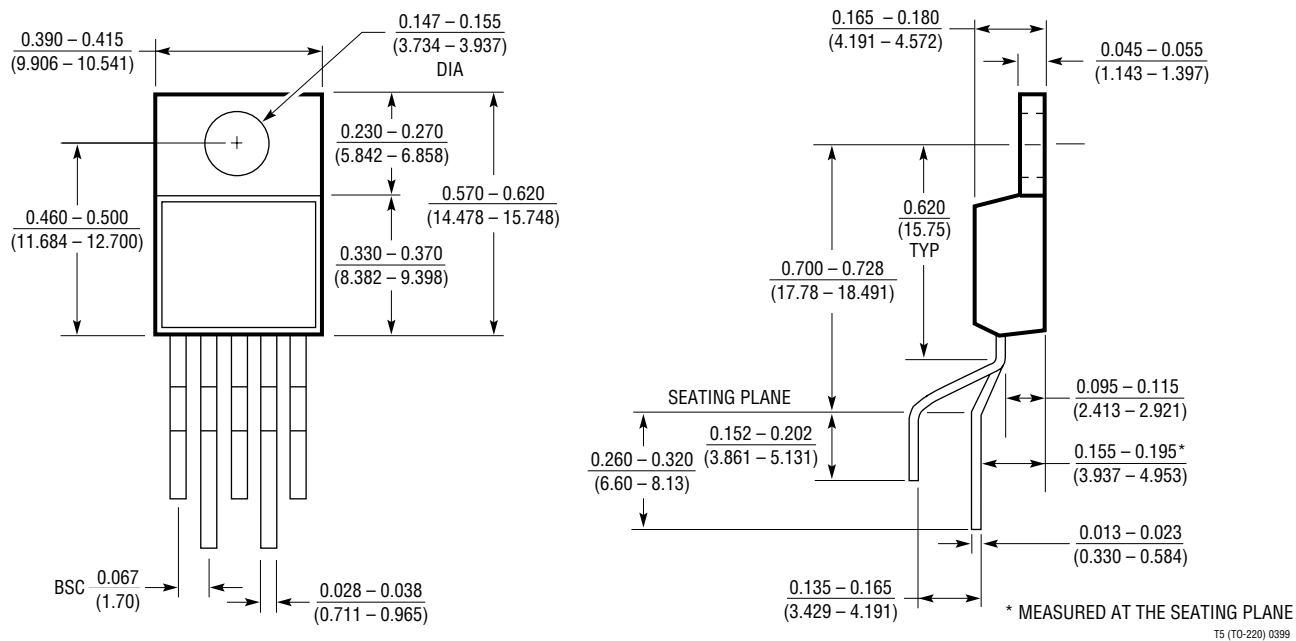

LT1764A Series

TYPICAL APPLICATION

Paralleling of Regulators for Higher Output Current

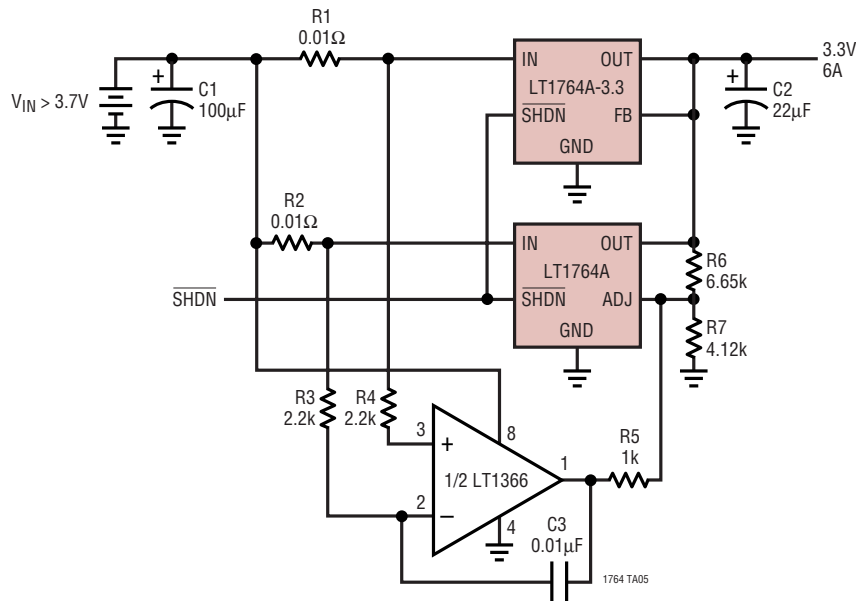

RELATED PARTS

PART NUMBER	DESCRIPTION	COMMENTS
LT1120	125mA Low Dropout Regulator with 20µA I _Q	Includes 2.5V Reference and Comparator
LT1121	150mA Micropower Low Dropout Regulator	30µA I _Q , SOT-223 Package
LT1129	700mA Micropower Low Dropout Regulator	50µA Quiescent Current
LT1175	500mA Negative Low Dropout Micropower Regulator	45µA I _Q , 0.26V Dropout Voltage, SOT-223 Package
LT1374	4.5A, 500kHz Step-Down Converter	4.5A, 0.07Ω Internal Switch, SO-8 Package
LT1521	300mA Low Dropout Micropower Regulator with Shutdown	15µA I _Q , Reverse Battery Protection
LT1529	3A Low Dropout Regulator with 50µA I _Q	500mV Dropout Voltage
LT1573	UltraFast™ Transient Response Low Dropout Regulator	Drives External PNP
LT1575	UltraFast Transient Response Low Dropout Regulator	Drives External N-Channel MOSFET
LTC1735	Synchronous Step-Down Converter	High Efficiency, OPTI-LOOP® Compensation
LT1761 Series	100mA, Low Noise, Low Dropout Micropower Regulators in SOT-23	20µA Quiescent Current, 20µV _{RMS} Noise, ThinSOT™ Package
LT1762 Series	150mA, Low Noise, LDO Micropower Regulators	25µA Quiescent Current, 20µV _{RMS} Noise, MSOP Package
LT1763 Series	500mA, Low Noise, LDO Micropower Regulators	30µA Quiescent Current, 20µV _{RMS} Noise, SO-8 Package
LT1962	300mA, Low Noise, LDO Micropower Regulator	20µV _{RMS} Noise, MSOP Package
LT1963A	1.5A, Low Noise, Fast Transient Response LDO	40µV _{RMS} Noise, SOT-223 Package
LT1964	200mA, Low Noise, Negative LDO Micropower Regulator	30µV _{RMS} Noise, ThinSOT Package

OPTI-LOOP is a registered trademark of Linear Technology Corporation. UltraFast and ThinSOT are trademarks of Linear Technology Corporation.