

TOSHIBA

TMP87CC20/H20/K20A/M20A

CMOS 8-Bit Microcontroller

TMP87CC20F, TMP87CH20F, TMP87CK20AF, TMP87CM20AF

The 87CC20/H20/K20A/M20A are high-speed and high-performance 8-bit single chip microcomputers. These MCU contain a LCD driver, multi-function timer/counters and a serial interface on a chip.

Part No.	ROM	RAM	Package	OTP MCU
TMP87CC20F	12 K × 8-bit	512 × 8-bit	P-QFP80-1420-0.80B	TMP87PH20F
TMP87CH20F	16 K × 8-bit			
TMP87CK20AF	24 K × 8-bit	1K × 8-bit		TMP87PM20F
TMP87CM20AF	32 K × 8-bit			

Features

- ◆ 8-bit single chip microcomputer TLCS-870 Series
- ◆ Instruction execution time: 0.5 μs (at 8 MHz), 122 μs (at 32.768 kHz)
- ◆ 412 basic instructions
 - Multiplication and Division (8 bits × 8 bits, 16 bits ÷ 8 bits)
 - Bit manipulations (set/clear/complement/move/test /exclusive or)
 - 16-bit data operations
 - 1-byte jump/subroutine-call (Short relative jump / Vector call)
- ◆ 13 interrupt sources (External: 4, Internal: 9)
 - All sources have independent latches each, and nested interrupt control is available.
 - 2 edge-selectable external interrupts with noise reject
 - High-speed task switching by register bank changeover
- ◆ 7 Input/Output ports (45 pins)
 - High current output: 2 pins (typ. 20 mA)
- ◆ 16-bit Timer/Counter
 - Timer, Event counter, Pulse width measurement, Frequency measurement modes
- ◆ Four 8-bit Timer/Counters
 - Timer, Event counter, Capture (Pulse width/duty measurement), PWM output, Programmable divider output modes
- ◆ Time Base Timer (Interrupt frequency: 1 Hz to 16 kHz)
- ◆ Divider output function (frequency: 1 kHz to 8 kHz)
- ◆ Watchdog Timer
 - Interrupt source / reset output (programmable)
- ◆ 8-bit Serial Interface
 - With 8 bytes transmit/receive data buffer
 - Internal/external serial clock, and 4/8-bit mode
- ◆ LCD driver/Controller
 - LCD direct drive capability (max. 16-digit display at 1/4 duty LCD).
 - 1/4, 1/3, 1/2 duties or static drive are programmably selectable.
 - With display memory.

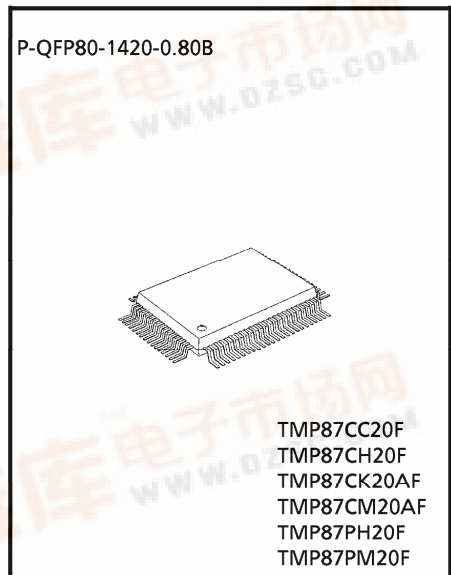

980910EBP1

● For a discussion of how the reliability of microcontrollers can be predicted, please refer to Section 1.3 of the chapter entitled Quality and Reliability Assurance / Handling Precautions.

● TOSHIBA is continually working to improve the quality and the reliability of its products. Nevertheless, semiconductor devices in general can malfunction or fail due to their inherent electrical sensitivity and vulnerability to physical stress. It is the responsibility of the buyer, when utilizing TOSHIBA products, to observe standards of safety, and to avoid situations in which a malfunction or failure of a TOSHIBA product could cause loss of human life, bodily injury or damage to property. In developing your designs, please ensure that TOSHIBA products are used within specified operating ranges as set forth in the most recent products specifications. Also, please keep in mind the precautions and conditions set forth in the TOSHIBA Semiconductor Reliability Handbook.

● The products described in this document are subject to the foreign exchange and foreign trade laws.

● The information contained herein is presented only as a guide for the applications of our products. No responsibility is assumed by TOSHIBA CORPORATION for any infringements of intellectual property or other rights of the third parties which may result from its use. No license is granted by implication or otherwise under any intellectual property or other rights of TOSHIBA CORPORATION or others.

● The information contained herein is subject to change without notice.



- ◆ Dual clock operation
 - Single/Dual-clock mode (option)
- ◆ Five power saving operating modes
 - STOP mode: Oscillation stops. Battery/Capacitor back-up. Port output hold/High-impedance.
 - SLOW mode: Low power consumption operation using low-frequency clock (32.768 kHz).
 - IDLE1 mode: CPU stops, and peripherals operate using high-frequency clock. Release by interrupts.
 - IDLE2 mode: CPU stops, and peripherals operate using high and low frequency clock. Release by interrupts.
 - SLEEP mode: CPU stops, and peripherals operate using low-frequency clock. Release by interrupts.
- ◆ Wide operating voltage: 2.7 to 6 V at 4.19 MHz / 32.768 kHz, 4.5 to 6 V at 8 MHz / 32.768 kHz
(87CC20/H20, PH20)
2.7 to 5.5 V at 4.19 MHz / 32.768 kHz, 4.5 to 5.5 V at 8 MHz / 32.768 kHz
(87CK20A/M20A, PM20)
- ◆ Emulation Pod: BM87CH20F0B

Pin Assignments (Top View)

P-QFP80-1420-0.80B

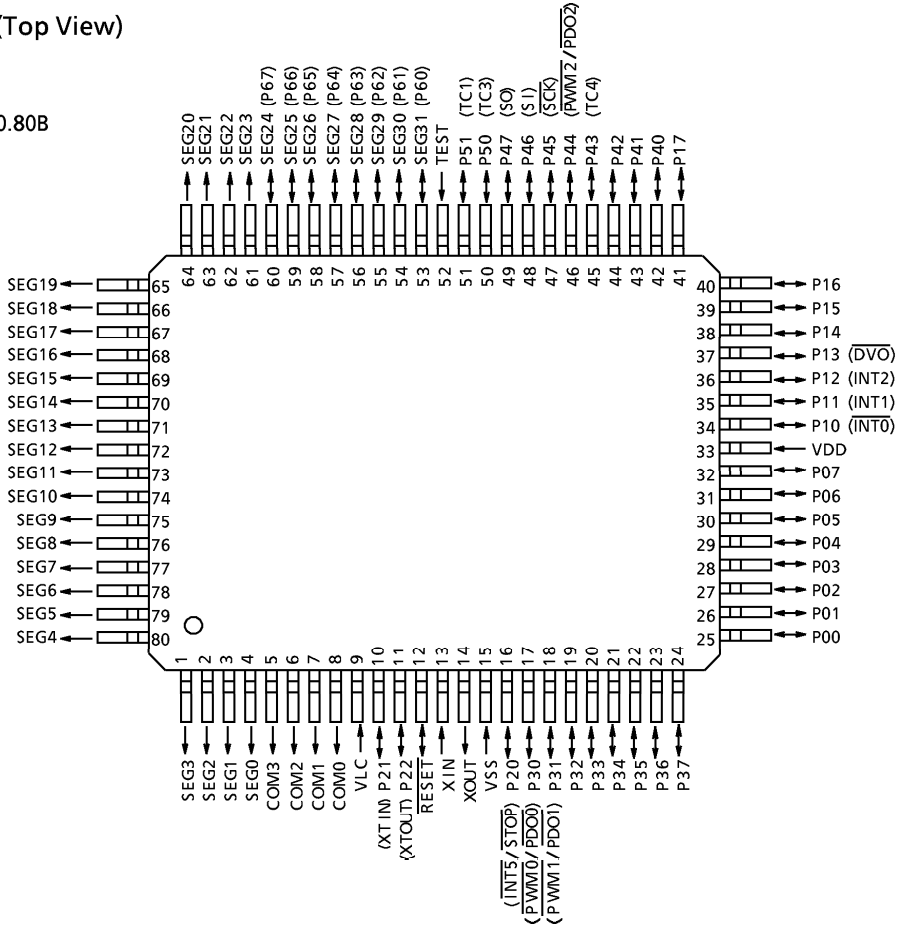

Block Diagram

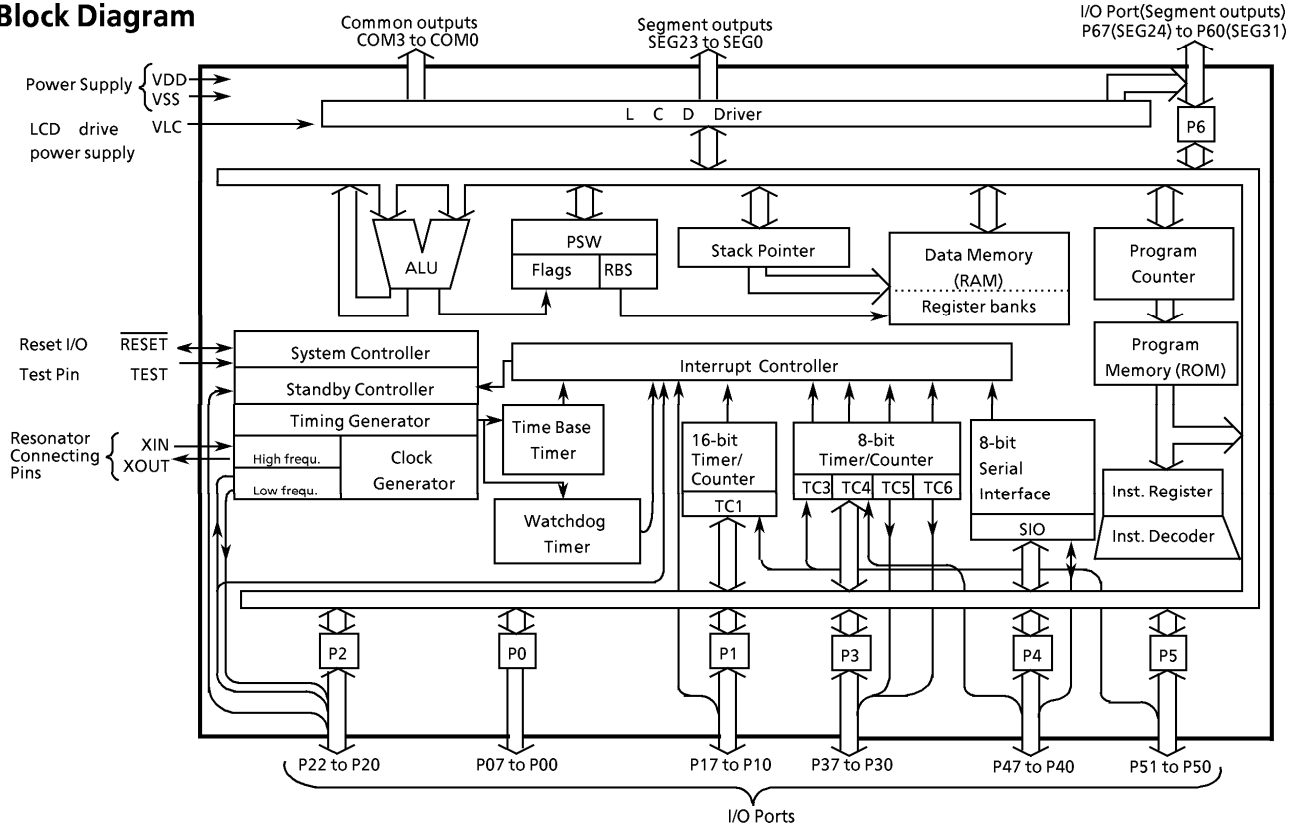

Pin Function

Pin Name	Input / Output	Function	
P07 to P00	I/O	Two 8-bit programmable input/output ports (tri-state).	
P17 to P14	I/O		
P13 ($\overline{\text{DVO}}$)	I/O (Output)	Each bit of these ports can be individually configured as an input or an output under software control. During reset, all bits are configured as inputs. When used as a divider output, the latch must be set to "1".	Divider output
P12 (INT2)	I/O (Input)		External interrupt input 2
P11 (INT1)			External interrupt input 1
P10 ($\overline{\text{INT0}}$)			External interrupt input 0
P22 (XTOUT)	I/O (Output)	3-bit input/output port with latch. When used as an input port, the latch must be set to "1".	Resonator connecting pins (32.768 kHz). For inputting external clock, XTIN is used and XTOUT is opened.
P21 (XTIN)	I/O (Input)		External interrupt input 5 or STOP mode release signal input
P20 ($\overline{\text{INT5/STOP}}$)			
P37 to P32	I/O	8-bit input/output port with latch. When used as an input port, a PWM output, or a PDO output, the latch must be set to "1".	8-bit $\overline{\text{PWM1}}$ output or 8-bit $\overline{\text{PDO1}}$ output 8-bit $\overline{\text{PWM0}}$ output or 8-bit $\overline{\text{PDO0}}$ output
P31 ($\overline{\text{PWM1}} / \overline{\text{PDO1}}$)	I/O (Output)		
P30 ($\overline{\text{PWM0}} / \overline{\text{PDO0}}$)			
P47 (SO)	I/O (Output)	8-bit input/output port with latch. When used as an input port, a timer/counter input, a PWM output, a PDO output, or a SIO input/output, the latch must be set to "1".	SIO serial data output
P46 (SI)	I/O (Input)		SIO serial data input
P45 ($\overline{\text{SCK}}$)	I/O (I/O)		SIO serial clock input/output
P44 ($\overline{\text{PWM2}} / \overline{\text{PDO2}}$)	I/O (Output)		8-bit $\overline{\text{PWM2}}$ output or 8-bit $\overline{\text{PDO2}}$ output
P43 (TC4)	I/O (Input)		Timer/Counter 4 input
P42 to P40	I/O		
P51 (TC1)	I/O (Input)	2-bit input/output port with latch. When used as an input port or a timer/counter input, the latch must be set to "1".	Timer/Counter 1 input
P50 (TC3)	I/O (Input)		Timer/Counter 3 input
P67 (SEG24) to P60 (SEG31)	I/O (Output)	8-bit input/output port with latch. When used as an input port, the latch must be set to "1".	LCD Segment outputs. When used as a segment output, the P6 control register (P6CR) must be set to "1".
SEG23 to SEG0	Output	LCD Segment outputs	
COM3 to COM0		LCD Common outputs	
XIN, XOUT	Input, Output	Resonator connecting pins for high-frequency clock. For inputting external clock, XIN is used and XOUT is opened.	
$\overline{\text{RESET}}$	I/O	Reset signal input or watchdog timer output/address-trap-reset output/system-clock-reset output.	
TEST	Input	Test pin for out-going test. Be tied to low.	
VDD, VSS	Power Supply	+ 5 V, 0 V (GND)	
VLC		LCD drive power supply	

OPERATIONAL DESCRIPTION

1. CPU CORE FUNCTIONS

The CPU core consists of a CPU, a system clock controller, an interrupt controller, and a watchdog timer. This section provides a description of the CPU core, the program memory (ROM), the data memory (RAM), and the reset circuit.

1.1 Memory Address Map

The TLCS-870 Series is capable of addressing 64K bytes of memory. Figure 1-1 shows the memory address maps of the 87CC20/H20/K20A/M20A.

In the TLCS-870 Series, the memory is organized 4 address spaces (ROM, RAM, SFR, and DBR). It uses a memory mapped I/O system, and all I/O registers are mapped in the SFR/DBR address spaces. There are 16 banks of general-purpose registers. The register banks are also assigned to the first 128 bytes of the RAM address space.

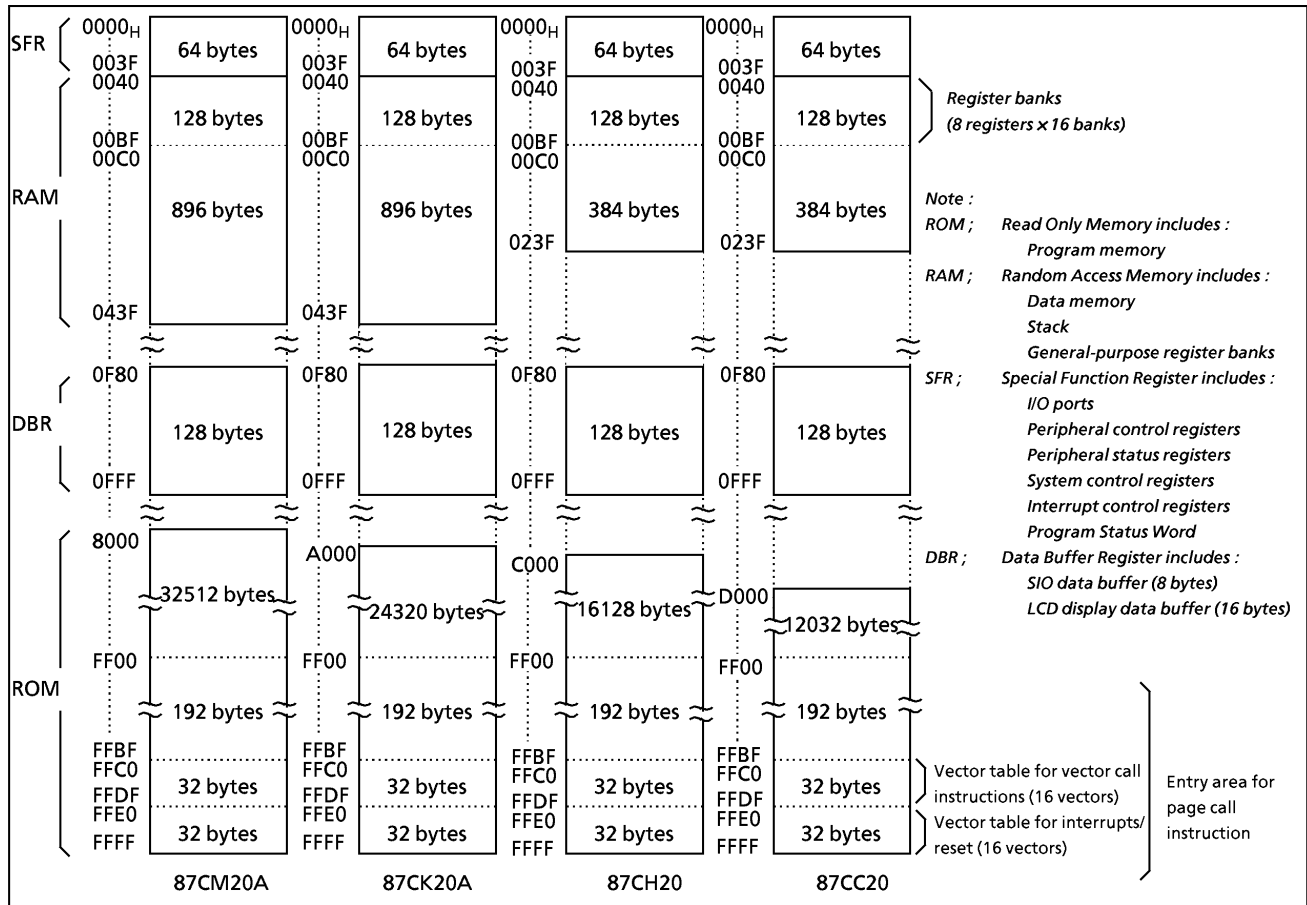

Figure 1-1. Memory Address Maps

1.2 Program Memory (ROM)

The 87CC20 has a 12K × 8-bit (addresses D000_H-FFFF_H), the 87CH20 has a 16K × 8-bit (addresses C000_H-FFFF_H), the 87CK20A has a 24K × 8-bit (addresses A000_H-FFFF_H), and the 87CM20A has a 32K × 8-bit (addresses 8000_H-FFFF_H) of program memory (mask programmed ROM).

Addresses FF00_H-FFFF_H in the program memory can also be used for special purposes.

(1) Interrupt/Reset vector table (addresses FFE0_H-FFFF_H)

This table consists of a reset vector and 15 interrupt vectors (2 bytes/vector). These vectors store a reset start address and interrupt service routine entry addresses.

Electrical Characteristics

(1) 87CC20/H20

Absolute Maximum Ratings

 $(V_{SS} = 0\text{ V})$

Parameter	Symbol	Condition	Ratings	Unit
Supply Voltage	V_{DD}		- 0.3 to 7	V
Input Voltage	V_{IN}		- 0.3 to $V_{DD} + 0.3$	V
Output Voltage	V_{OUT1}	Except sink open drain pin, but include P21, P22, P6 and RESET	- 0.3 to $V_{DD} + 0.3$	V
	V_{OUT2}	Sink open drain pin except port P21, P22, P6 and RESET	0.3 to 10	
Output Current (Per 1 pin)	I_{OUT1}	Ports P0, P1, P2, P3 (Except P30, P31), P4, P5, P6	3.2	mA
	I_{OUT2}	Only P30, P31	30	
Output Current (Total)	ΣI_{OUT1}	Ports P0, P1, P2, P3 (Except P30, P31), P4, P5, P6	120	mA
	ΣI_{OUT2}	Only P30, P31	60	
Power Dissipation [$T_{opr} = 70\text{ }^\circ\text{C}$]	PD		350	mW
Soldering Temperature (time)	T_{sld}		260 (10 s)	$^\circ\text{C}$
Storage Temperature	T_{stg}		- 55 to 125	$^\circ\text{C}$
Operating Temperature	T_{opr}		- 30 to 70	$^\circ\text{C}$

Note: The absolute maximum ratings are rated values which must not be exceeded during operation, even for an instant. Any one of the ratings must not be exceeded. If any absolute maximum rating is exceeded, a device may break down or its performance may be degraded, causing it to catch fire or explode resulting in injury to the user. Thus, when designing products which include this device, ensure that no absolute maximum rating value will ever be exceeded.

Recommended Operating Conditions

 $(V_{SS} = 0\text{V}, T_{opr} = -30\text{ to }70\text{ }^\circ\text{C})$

Parameter	Symbol	Pins	Conditions	Min	Max	Unit	
Supply Voltage	V_{DD}		$f_c = 8\text{ MHz}$	NORMAL 1, 2 mode	4.5	6.0	V
				IDLE1, 2 mode			
			$f_c = 4.2\text{ MHz}$	NORMAL1, 2 mode	2.7		
				IDLE1, 2 mode			
			$f_s = 32.768\text{ kHz}$	SLOW mode	2.0		
SLEEP mode							
	STOP mode						
Input High Voltage	V_{IH1}	Except hysteresis input	$V_{DD} \geq 4.5\text{ V}$	$V_{DD} \times 0.70$	V_{DD}	V	
	V_{IH2}	Hysteresis input		$V_{DD} \times 0.75$			
	V_{IH3}			$V_{DD} < 4.5\text{ V}$			$V_{DD} \times 0.90$
Input Low Voltage	V_{IL1}	Except hysteresis input	$V_{DD} \geq 4.5\text{ V}$	0	$V_{DD} \times 0.30$	V	
	V_{IL2}	Hysteresis input			$V_{DD} \times 0.25$		
	V_{IL3}				$V_{DD} < 4.5\text{ V}$		$V_{DD} \times 0.10$
Clock Frequency	f_c	XIN, XOUT	$V_{DD} = 4.5\text{ to }6\text{ V}$	0.4	8.0	MHz	
			$V_{DD} = 2.7\text{ to }6\text{ V}$		4.2		
	f_s	XTIN, XTOUT		30.0	34.0	kHz	

Note 1: The recommended operating conditions for a device are operating conditions under which it can be guaranteed that the device will operate as specified. If the device is used under operating conditions other than the recommended operating conditions (supply voltage, operating temperature range, specified AC/DC values etc.), malfunction may occur. Thus, when designing products which include this device, ensure that the recommended operating conditions for the device are always adhered to.

Note 2: Clock frequency f_c : Supply voltage range is specified in NORMAL1/2 mode and IDLE1/2 mode.

D.C.Characteristics

(V_{SS} = 0 V, Topr = -30 to 70°C)

Parameter	Symbol	Pins	Conditions	Min	Typ.	Max	Unit				
Hysteresis Voltage	V _{HS}	Hysteresis input		-	0.9	-	V				
Input Current	I _{IN1}	TEST	V _{DD} = 5.5 V V _{IN} = 5.5 V / 0 V	-	-	± 2	μA				
	I _{IN2}	Open drain port and tri-state port									
	I _{IN3}	RESET, STOP									
Input Low Current	I _{IL}	Push-pull port	V _{DD} = 5.5 V, V _{IN} = 0.4 V	-	-	- 2	mA				
Input Resistance	R _{IN2}	RESET		100	220	450	kΩ				
Output Leakage Current	I _{LO}	Open drain port and	V _{DD} = 5.5 V, V _{OUT} = 5.5 V	-	-	2	μA				
		tri-state port	V _{DD} = 5.5 V, V _{OUT} = 5.5 V / 0 V	-	-	± 2					
Output High Voltage	V _{OH1}	Push-pull port	V _{DD} = 4.5 V, I _{OH} = - 200 μA	2.4	-	-	V				
	V _{OH2}	Tri-state port	V _{DD} = 4.5 V, I _{OH} = - 0.7 mA	4.1	-	-					
Output Low Voltage	V _{OL}	Except XOUT and P30, P31	V _{DD} = 4.5 V, I _{OL} = 1.6 mA	-	-	0.4	V				
Output Low Current	I _{OL3}	Only P30, P31	V _{DD} = 4.5 V, V _{OL} = 1.0 V	-	20	-	mA				
Supply Current in NORMAL 1, 2 mode	I _{DD}		V _{DD} = 5.5 V f _c = 8 MHz f _s = 32.768 kHz V _{IN} = 5.3 V / 0.2 V	-	8	14	mA				
Supply Current in IDLE 1, 2 mode				-	4	6	mA				
Supply Current in NORMAL 1, 2 mode				-	2.5	3.5	mA				
Supply Current in IDLE 1, 2 mode								-	1.5	2.0	mA
Supply Current in SLOW mode				-	30	60	μA				
Supply Current in SLEEP mode				-	15	30	μA				
Supply Current in STOP mode				-	0.5	10	μA				
Segment Output Low Resistance	R _{OS1}	SEG31 to SEG0	V _{DD} = 5 V V _{DD} - V _{LC} = 3 V	-	20	-	kΩ				
Common Output Low Resistance	R _{OC1}	COM3 to COM0									
Segment Output High Resistance	R _{OS2}	SEG31 to SEG0									
Common Output High Resistance	R _{OC2}	COM3 to COM0									
Segment /Common Output Voltage	V _{O2/3}	SEG31 to SEG0 and COM3 to COM0 pins						3.8	4.0	4.2	V
	V _{O1/2}							3.3	3.5	3.7	
	V _{O1/3}							2.8	3.0	3.2	

Note 1: Typical values show those at Topr = 25°C, V_{DD} = 5 V.

Note 2: Input Current ; The current through pull-up or pull-down resistor is not included.

Note 3: Output resistance R_{OS} and R_{OC} indicate "on" when switching levels.

Note 4: V_{O2/3} indicates an output current at the 2/3 level when operating in the 1/4 or 1/3 duty mode.

Note 5: V_{O1/2} indicates an output current at the 1/2 level when operating in the 1/2 duty or static mode.

Note 6: V_{O1/3} indicates an output current at the 1/3 level when operating in the 1/4 or 1/3 duty mode.

Note 7: When you use a liquid crystal display (LCD), it is necessary to give careful consideration to the value of the output resistor R_{OS1/2}, R_{OC1/2}.

Note 8: R_{OS1}, R_{OC1}: On time of the lower output resistor is 2⁶/f_c, 2/f_s [s]

Note 9: R_{OS2}, R_{OC2}: On time of the higher output resistor is 1/(n/f_F) (1/n duty, f_F: frame frequency)

A.C. Characteristics

($V_{SS} = 0\text{ V}$, $V_{DD} = 4.5\text{ to }6.0\text{ V}$, $T_{opr} = -30\text{ to }70^\circ\text{C}$)

Parameter	Symbol	Conditions	Min	Typ.	Max	Unit
Machine Cycle Time	t_{cy}	In NORMAL1, 2 modes	0.5	-	10	μs
		In IDLE 1, 2 modes				
		In SLOW mode	117.6	-	133.3	
		In SLEEP mode				
High Level Clock Pulse Width	t_{WCH}	For external clock operation (XIN input), $f_c = 8\text{ MHz}$	50	-	-	ns
Low Level Clock Pulse Width	t_{WCL}					
High Level Clock Pulse Width	t_{WSH}	For external clock operation (XTIN input), $f_s = 32.768\text{ kHz}$	14.7	-	-	μs
Low Level Clock Pulse Width	t_{WSL}					
Frequency of TC1 input	t_{TC1}	Frequency Measurement mode	-	-	f_c	MHz

Recommended Oscillating Condition

($V_{SS} = 0\text{ V}$, $V_{DD} = 4.5\text{ to }6.0\text{ V}$, $T_{opr} = -30\text{ to }70^\circ\text{C}$)

Parameter	Oscillator	Frequency	Recommended Oscillator	Recommended Condition	
				C_1	C_2
High-frequency	Ceramic Resonator	8 MHz	KYOCERA KBR8.0M	30pF	30pF
		4 MHz	KYOCERA KBR4.0MS MURATA CSA4.00MG		
	Crystal Oscillator	8 MHz	TOYOCOM 210B 8.0000	20pF	20pF
		4 MHz	TOYOCOM 204B 4.0000		
Low-frequency	Crystal Oscillator	32.768 kHz	NDK MX-38T	15pF	15pF

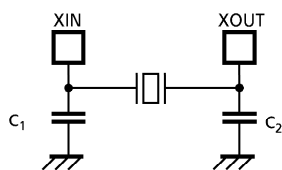

(1) High-frequency

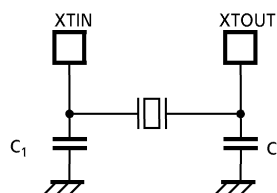

(2) Low-frequency

Note: An electrical shield by metal shield plate on the surface of IC package should be recommendable in order to prevent the device from the high electric fieldstress applied from CRT (Cathode Ray Tube) for continuous reliable operation.

Electrical Characteristics

(2) 87CK20A/M20A

Absolute Maximum Ratings

 $(V_{SS} = 0\text{ V})$

Parameter	Symbol	Condition	Ratings	Unit
Supply Voltage	V_{DD}		- 0.3 to 6.5	V
Input Voltage	V_{IN}		- 0.3 to $V_{DD} + 0.3$	V
Output Voltage	V_{OUT1}	Except sink open drain pin, but include P21, P22, P6 and \overline{RESET}	- 0.3 to $V_{DD} + 0.3$	V
	V_{OUT2}	Sink open drain pin except port P21, P22, P6 and \overline{RESET}	- 0.3 to 5.5	
Output Current (Per 1 pin)	I_{OUT1}	Ports P0, P1, P2, P3 (Except P30, P31), P4, P5, P6	3.2	mA
	I_{OUT2}	Only P30, P31	30	
Output Current (Total)	ΣI_{OUT1}	Ports P0, P1, P2, P3 (Except P30, P31), P4, P5, P6	120	mA
	ΣI_{OUT2}	Only P30, P31	60	
Power Dissipation [$T_{opr} = 70^{\circ}\text{C}$]	PD		350	mW
Soldering Temperature (time)	T_{sld}		260 (10 s)	$^{\circ}\text{C}$
Storage Temperature	T_{stg}		- 55 to 125	$^{\circ}\text{C}$
Operating Temperature	T_{opr}		- 30 to 70	$^{\circ}\text{C}$

Note: The absolute maximum ratings are rated values which must not be exceeded during operation, even for an instant. Any one of the ratings must not be exceeded. If any absolute maximum rating is exceeded, a device may break down or its performance may be degraded, causing it to catch fire or explode resulting in injury to the user. Thus, when designing products which include this device, ensure that no absolute maximum rating value will ever be exceeded.

Recommended Operating Conditions

 $(V_{SS} = 0\text{ V}, T_{opr} = -30\text{ to }70^{\circ}\text{C})$

Parameter	Symbol	Pins	Conditions	Min	Max	Unit	
Supply Voltage	V_{DD}		$f_c = 8\text{ MHz}$	NORMAL 1, 2 mode	4.5	5.5	V
				IDLE 1, 2 mode			
			$f_c = 4.2\text{ MHz}$	NORMAL 1, 2 mode	2.7		
				IDLE 1, 2 mode			
			$f_s = 32.768\text{ kHz}$	SLOW mode	2.0		
SLEEP mode							
Input High Voltage	V_{IH1}	Except hysteresis input	$V_{DD} \geq 4.5\text{ V}$	$V_{DD} \times 0.70$	V_{DD}	V	
	V_{IH2}	Hysteresis input		$V_{DD} \times 0.75$			
	V_{IH3}			$V_{DD} < 4.5\text{ V}$			$V_{DD} \times 0.90$
Input Low Voltage	V_{IL1}	Except hysteresis input	$V_{DD} \geq 4.5\text{ V}$	0	$V_{DD} \times 0.30$	V	
	V_{IL2}	Hysteresis input			$V_{DD} \times 0.25$		
	V_{IL3}				$V_{DD} < 4.5\text{ V}$		$V_{DD} \times 0.10$
Clock Frequency	f_c	XIN, XOUT	$V_{DD} = 4.5\text{ to }5.5\text{ V}$	0.4	8.0	MHz	
			$V_{DD} = 2.7\text{ to }5.5\text{ V}$		4.2		
	f_s	XTIN, XTOUT		30.0	34.0	kHz	

Note: The recommended operating conditions for a device are operating conditions under which it can be guaranteed that the device will operate as specified. If the device is used under operating conditions other than the recommended operating conditions (supply voltage, operating temperature range, specified AC/DC values etc.), malfunction may occur. Thus, when designing products which include this device, ensure that the recommended operating conditions for the device are always adhered to.

D.C.Characteristics

 $(V_{SS} = 0\text{ V}, T_{opr} = -30\text{ to }70^{\circ}\text{C})$

Parameter	Symbol	Pins	Conditions	Min	Typ.	Max	Unit				
Hysteresis Voltage	V_{HS}	Hysteresis input		-	0.9	-	V				
Input Current	I_{IN1}	TEST	$V_{DD} = 5.5\text{ V}$ $V_{IN} = 5.5\text{ V} / 0\text{ V}$	-	-	± 2	μA				
	I_{IN2}	Open drain port and tri-state port									
	I_{IN3}	$\overline{\text{RESET}}$, $\overline{\text{STOP}}$									
Input Low Current	I_{IL}	Push-pull port	$V_{DD} = 5.5\text{ V}, V_{IN} = 0.4\text{ V}$	-	-	-2	mA				
Input Resistance	R_{IN2}	$\overline{\text{RESET}}$		100	220	450	$\text{k}\Omega$				
Output Leakage Current	I_{LO}	Open drain port and	$V_{DD} = 5.5\text{ V}, V_{OUT} = 5.5\text{ V}$	-	-	2	μA				
		tri-state port	$V_{DD} = 5.5\text{ V}, V_{OUT} = 5.5\text{ V} / 0\text{ V}$	-	-	± 2					
Output High Voltage	V_{OH1}	Push-pull port	$V_{DD} = 4.5\text{ V}, I_{OH} = -200\ \mu\text{A}$	2.4	-	-	V				
	V_{OH2}	Tri-state port	$V_{DD} = 4.5\text{ V}, I_{OH} = -0.7\text{ mA}$	4.1	-	-					
Output Low Voltage	V_{OL}	Except XOUT and P30, P31	$V_{DD} = 4.5\text{ V}, I_{OL} = 1.6\text{ mA}$	-	-	0.4	V				
Output Low Current	I_{OL3}	Only P30, P31	$V_{DD} = 4.5\text{ V}, V_{OL} = 1.0\text{ V}$	-	20	-	mA				
Supply Current in NORMAL 1, 2 mode	I_{DD}		$V_{DD} = 5.5\text{ V}$ $f_c = 8\text{ MHz}$ $f_s = 32.768\text{ kHz}$ $V_{IN} = 5.3\text{ V} / 0.2\text{ V}$	-	10	16	mA				
Supply Current in IDLE 1, 2 mode				-	4.5	6	mA				
Supply Current in NORMAL 1, 2 mode				-	3.5	4.5	mA				
Supply Current in IDLE 1, 2 mode							-	1.5	2.0	mA	
Supply Current in SLOW mode							-	30	60	μA	
Supply Current in SLEEP mode				-	15	30	μA				
Supply Current in STOP mode				-	0.5	10	μA				
Segment Output Low Resistance	R_{OS1}	SEG31 to SEG0	$V_{DD} = 5\text{ V}$ $V_{DD} - V_{LC} = 3\text{ V}$	-	20	-	$\text{k}\Omega$				
Common Output Low Resistance	R_{OC1}	COM3 to COM0									
Segment Output High Resistance	R_{OS2}	SEG31 to SEG0									
Common Output High Resistance	R_{OC2}	COM3 to COM0									
Segment /Common Output Voltage	$V_{O2/3}$	SEG31 to SEG0 and COM3 to COM0 pins						3.8	4.0	4.2	V
	$V_{O1/2}$							3.3	3.5	3.7	
	$V_{O1/3}$							2.8	3.0	3.2	

Note 1: Typical values show those at $T_{opr} = 25^{\circ}\text{C}$, $V_{DD} = 5\text{ V}$.

Note 2: Input Current ; The current through pull-up or pull-down resistor is not included.

Note 3: Output resistance R_{OS} and R_{OC} indicate "on" when switching levels.

Note 4: $V_{O2/3}$ indicates an output current at the 2/3 level when operating in the 1/4 or 1/3 duty mode.

Note 5: $V_{O1/2}$ indicates an output current at the 1/2 level when operating in the 1/2 duty or static mode.

Note 6: $V_{O1/3}$ indicates an output current at the 1/3 level when operating in the 1/4 or 1/3 duty mode.

Note 7: When you use a liquid crystal display (LCD), it is necessary to give careful consideration to the value of the output resistor $R_{OS1/2}$, $R_{OC1/2}$.

Note 8: R_{OS1} , R_{OC1} : On time of the lower output resistor is $2^6/f_c$, $2/f_s$ [s]

Note 9: R_{OS2} , R_{OC2} : On time of the higher output resistor is $1/(n/fF)$ ($1/n$ duty, fF : frame frequency)

A.C. Characteristics

($V_{SS} = 0\text{ V}$, $V_{DD} = 4.5\text{ to }5.5\text{ V}$, $T_{opr} = -30\text{ to }70^\circ\text{C}$)

Parameter	Symbol	Conditions	Min	Typ.	Max	Unit
Machine Cycle Time	t_{cy}	In NORMAL1, 2 mode	0.5	-	10	μs
		In IDLE 1, 2 mode				
		In SLOW mode	117.6	-	133.3	
		In SLEEP mode				
High Level Clock Pulse Width	t_{WCH}	For external clock operation (XIN input), $f_c = 8\text{ MHz}$	50	-	-	ns
Low Level Clock Pulse Width	t_{WCL}					
High Level Clock Pulse Width	t_{WSH}	For external clock operation (XTIN input), $f_s = 32.768\text{ kHz}$	14.7	-	-	μs
Low Level Clock Pulse Width	t_{WSL}					
Frequency of TC1 input	t_{TC1}	Frequency Measurement mode	-	-	f_c	MHz

Recommended Oscillating Condition

($V_{SS} = 0\text{ V}$, $V_{DD} = 4.5\text{ to }5.5\text{ V}$, $T_{opr} = -30\text{ to }70^\circ\text{C}$)

Parameter	Oscillator	Frequency	Recommended Oscillator	Recommended Condition	
				C_1	C_2
High-frequency	Ceramic Resonator	8MHz	KYOCERA KBR8.0M	30pF	30pF
		4MHz	KYOCERA KBR4.0MS MURATA CSA4.00MG		
	Crystal Oscillator	8MHz	TOYOCOM 210B 8.0000	20pF	20pF
		4MHz	TOYOCOM 204B 4.0000		
Low-frequency	Crystal Oscillator	32.768kHz	NDK MX-38T	15pF	15pF

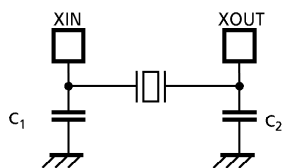

(1) High-frequency

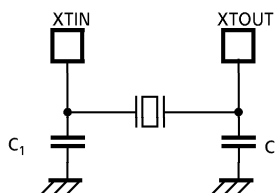

(2) Low-frequency

Note: An electrical shield by metal shield plate on the surface of IC package should be recommendable in order to prevent the device from the high electric fieldstress applied from CRT (Cathode Ray Tube) for continuous reliable operation.