



TS982

RAIL TO RAIL HIGH OUTPUT CURRENT DUAL OPERATIONAL AMPLIFIER

- Operating from **Vcc=2.5V to 5.5V**
- **200mA** output current on each amplifier
- High dissipation package
- Rail to Rail input and output
- Unity-Gain Stable

DESCRIPTION

The TS982 is a dual operational amplifier able to drive 200mA down to voltages as low as 2.7V.

The SO8 Exposed-Pad package allows high current output at high ambient temperatures making it a reliable solution for automotive and industrial applications.

The TS982 is stable with a unity gain.

APPLICATIONS

- Hall Sensor Compensation Coil
- Servo Amplifier
- Motor Driver
- Industrial
- Automotive

ORDER CODE

Part Number	Temperature Range	Package
TS982DW	-40°C, +125°C	SO8 Exposed-Pad
TS982DWT		

DW = SO8 Exposed Pad available in Tray)

DWT = SO8 Exposed Pad available in Tape & Reel

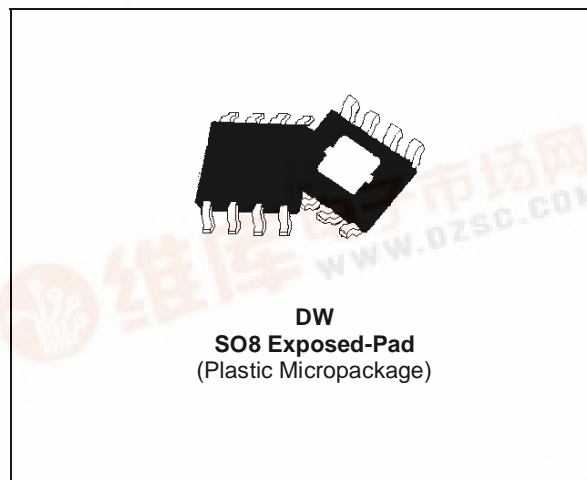

PIN CONNECTIONS (top view)

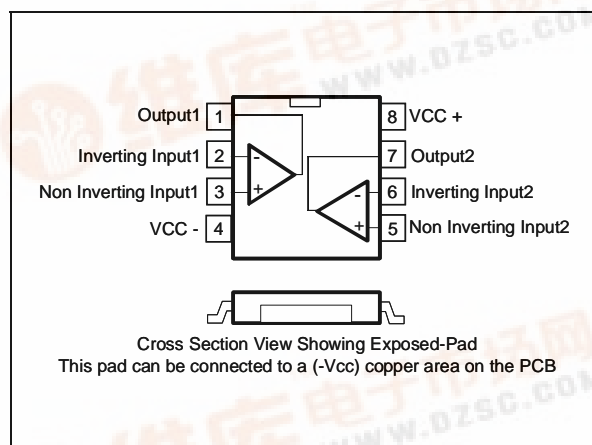

ABSOLUTE MAXIMUM RATINGS

Symbol	Parameter	Value	Unit
V_{CC}	Supply voltage ¹⁾	6	V
V_i	Input Voltage	-0.3v to $V_{CC}+0.3v$	V
T_{oper}	Operating Free Air Temperature Range	-40 to + 125	°C
T_{stg}	Storage Temperature	-65 to +150	°C
T_j	Maximum Junction Temperature	150	°C
R_{thja}	Thermal Resistance Junction to Ambient ²⁾	45	°C/W
R_{thjc}	Thermal Resistance Junction to Case	10	°C/W
ESD	Human Body Model (HBM)	2	kV
ESD	Charge Device Model (CDM)	1.5	kV
ESD	Machine Model (MM)	200	V
Latch-up	Latch-up Immunity (All pins)	200	mA
	Lead Temperature (soldering, 10sec)	250	°C
	Output Short-Circuit Duration	see note ³⁾	

1. All voltage values are measured with respect to the ground pin.

2. With two sides, two planes PCB following EIA/JEDEC JESD51-7 standard.

3. Short-circuits can cause excessive heating. Destructive dissipation can result from a short-circuit on one or two amplifiers simultaneously.

OPERATING CONDITIONS

Symbol	Parameter	Value	Unit
V_{CC}	Supply Voltage	2.5 to 5.5	V
V_{ICM}	Common Mode Input Voltage Range	G_{ND} to V_{CC}	V
C_L	Load Capacitor $R_L < 100\Omega$ $R_L > 100\Omega$	400 100	pF

ELECTRICAL CHARACTERISTICS

$V_{CC} = +5V$, $V_{CC-} = 0V$, $T_{amb} = 25^{\circ}C$ (unless otherwise specified)

Symbol	Parameter	Min.	Typ.	Max.	Unit
I_{CC}	Supply Current No input signal, no load		5.5	7.2	mA
V_{IO}	Input Offset Voltage ($V_{ICM} = V_{CC}/2$)		1	5	mV
ΔV_{IO}	Input Offset Voltage Drift		2		$\mu V/^{\circ}C$
I_{IB}	Input Bias Current $V_{ICM} = V_{CC}/2$		200	500	nA
I_{IO}	Input Offset Current $V_{ICM} = V_{CC}/2$		10		nA
V_{OH}	High Level Output Voltage $R_L = 16\Omega$ $I_{out} = 200mA$	4.2	4.4 4		V
V_{OL}	Low Level Output Voltage $R_L = 16\Omega$ $I_{out} = 200mA$		0.55 1	0.65	V
A_{VD}	Large Signal Voltage Gain $R_L = 16\Omega$		95		dB
GBP	Gain Bandwidth Product $R_L = 32\Omega$	1.35	2.2		MHz
CMR	Common Mode Rejection Ratio		80		dB
SVR	Supply Voltage Rejection Ratio		95		dB
SR	Slew Rate, Unity Gain Inverting $R_L = 16\Omega$	0.45	0.7		V/ μs
Φ_m	Phase Margin at Unit Gain $R_L = 16\Omega$, $C_L = 400pF$		56		degrees
G_m	Gain Margin $R_L = 16\Omega$, $C_L = 400pF$		18		dB
e_n	Equivalent Input Noise Voltage $F = 1 kHz$		17		$\frac{nV}{\sqrt{Hz}}$
Crosstalk	Channel Separation $R_L = 16\Omega$, $F = 1kHz$		100		dB

ELECTRICAL CHARACTERISTICS

$V_{CC} = +3.3V$, $V_{CC-} = 0V$, $T_{amb} = 25^{\circ}C$ (unless otherwise specified)¹⁾

Symbol	Parameter	Min.	Typ.	Max.	Unit
I_{CC}	Supply Current No input signal, no load		5.3	7.2	mA
V_{IO}	Input Offset Voltage ($V_{ICM} = V_{CC}/2$)		1	5	mV
ΔV_{IO}	Input Offset Voltage Drift		2		$\mu V/^{\circ}C$
I_{IB}	Input Bias Current $V_{ICM} = V_{CC}/2$		200	500	nA
I_{IO}	Input Offset Current $V_{ICM} = V_{CC}/2$		10		nA
V_{OH}	High Level Output Voltage $R_L = 16\Omega$ $I_{out} = 200mA$	2.68	2.85 2.3		V
V_{OL}	Low Level Output Voltage $R_L = 16\Omega$ $I_{out} = 200mA$		0.45 1	0.52	V
A_{VD}	Large Signal Voltage Gain $R_L = 16\Omega$		92		dB
GBP	Gain Bandwidth Product $R_L = 32\Omega$	1.2	2		MHz
CMR	Common Mode Rejection Ratio		75		dB
SVR	Supply Voltage Rejection Ratio		95		dB
SR	Slew Rate, Unity Gain Inverting $R_L = 16\Omega$	0.45	0.7		V/ μs
Φ_m	Phase Margin at Unit Gain $R_L = 16\Omega$, $C_L = 400pF$		57		degrees
G_m	Gain Margin $R_L = 16\Omega$, $C_L = 400pF$		16		dB
e_n	Equivalent Input Noise Voltage $F = 1\text{ kHz}$		17		$\frac{nV}{\sqrt{Hz}}$
Crosstalk	Channel Separation $R_L = 16\Omega$, $F = 1kHz$		100		dB

1) All electrical values are guaranteed by correlation with measurements at 2.7V and 5V.

ELECTRICAL CHARACTERISTICS

$V_{CC} = +2.7V$, $V_{CC-} = 0V$, $T_{amb} = 25^{\circ}C$ (unless otherwise specified)¹⁾

Symbol	Parameter	Min.	Typ.	Max.	Unit
I_{CC}	Supply Current No input signal, no load		5	7.2	mA
V_{IO}	Input Offset Voltage ($V_{ICM} = V_{CC}/2$)		1	5	mV
ΔV_{IO}	Input Offset Voltage Drift		2		$\mu V/^{\circ}C$
I_{IB}	Input Bias Current $V_{ICM} = V_{CC}/2$		200	500	nA
I_{IO}	Input Offset Current $V_{ICM} = V_{CC}/2$		10		nA
V_{OH}	High Level Output Voltage $R_L = 16\Omega$ $I_{out} = 200mA$	1.97	2.15 1.7		V
V_{OL}	Low Level Output Voltage $R_L = 16\Omega$ $I_{out} = 200mA$		0.35 1	0.45	V
A_{VD}	Large Signal Voltage Gain $R_L = 16\Omega$		90		dB
GBP	Gain Bandwidth Product $R_L = 320\Omega$	1.2	2		MHz
CMR	Common Mode Rejection Ratio		75		dB
SVR	Supply Voltage Rejection Ratio $V_{CC} = TBD$ to TBD V		95		dB
SR	Slew Rate, Unity Gain Inverting $R_L = 16\Omega$	0.42	0.65		V/ μs
Φ_m	Phase Margin at Unit Gain $R_L = 16\Omega$, $C_L = 400pF$		57		degrees
G_m	Gain Margin $R_L = 16\Omega$, $C_L = 400pF$		16		dB
e_n	Equivalent Input Noise Voltage $F = 1$ kHz		17		$\frac{nV}{\sqrt{Hz}}$
Crosstalk	Channel Separation $R_L = 16\Omega$, $F = 1kHz$		100		dB

1) All electrical values are guaranteed by correlation with measurements at 2.7V and 5V.

Current Consumption vs Supply Voltage

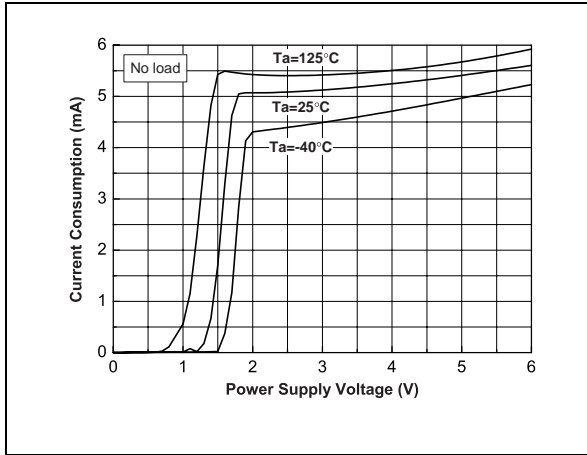

Voltage Drop vs Output Sourcing Current

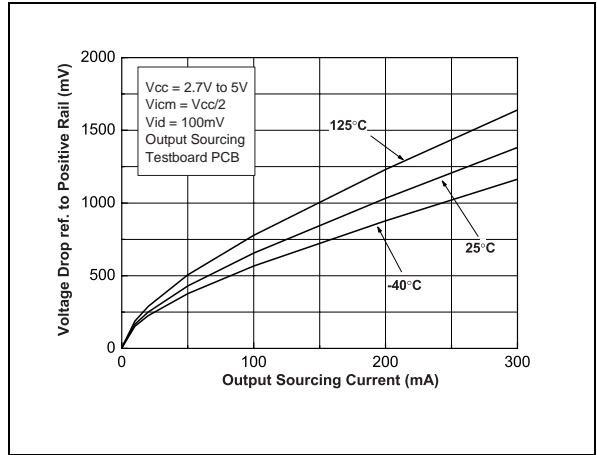

Voltage Drop vs Output Sinking Current

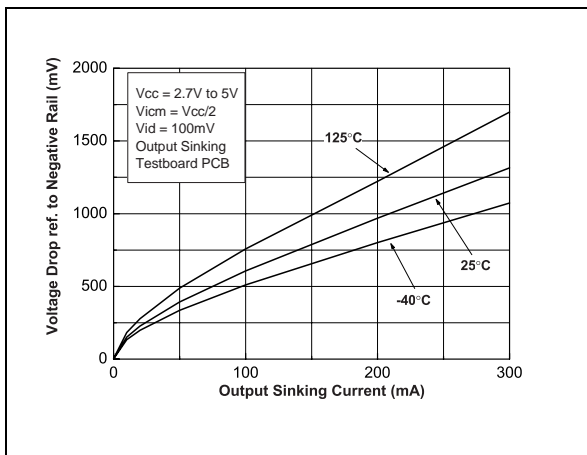

Voltage Drop vs Supply Voltage (Sourcing)

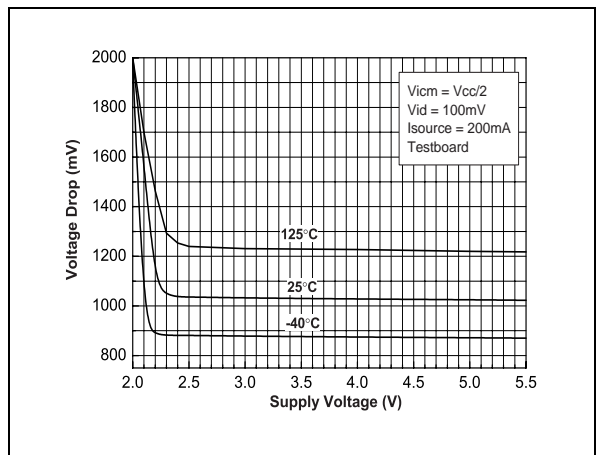

Voltage Drop vs Supply Voltage (Sinking)

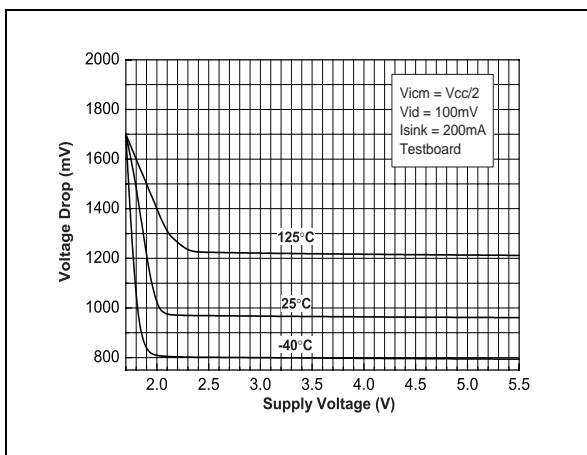

Voltage Drop vs Temperature (Iout=50mA)

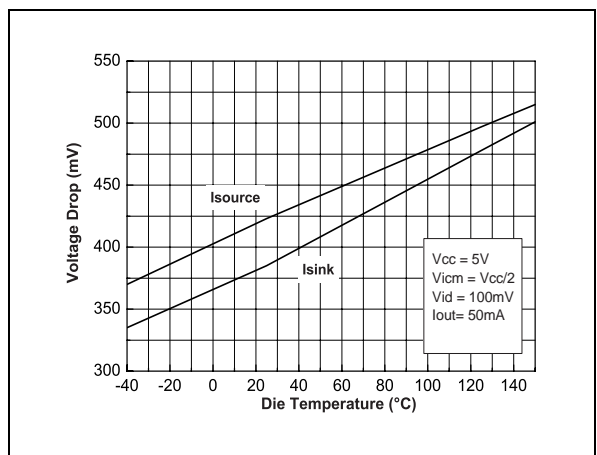

Voltage Drop vs Temperature (Iout=100mA)

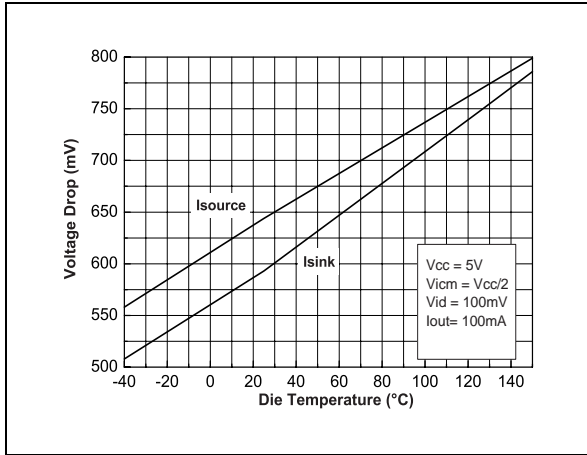

Voltage Drop vs Temperature (Iout=200mA)

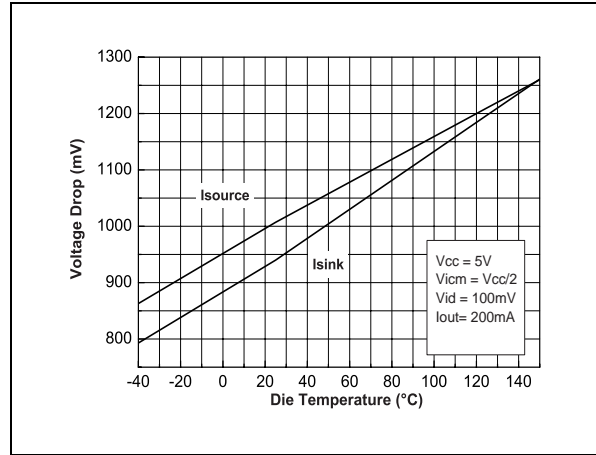

Open Loop Gain and Phase vs Frequency

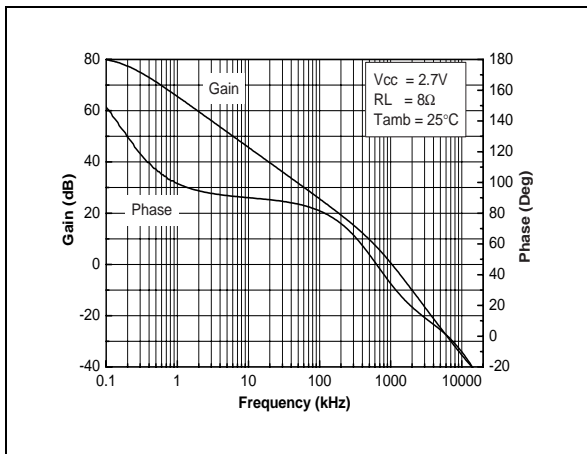

Open Loop Gain and Phase vs Frequency

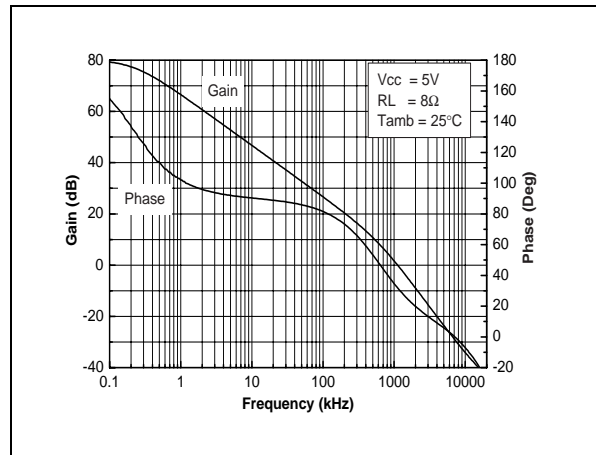

Open Loop Gain and Phase vs Frequency

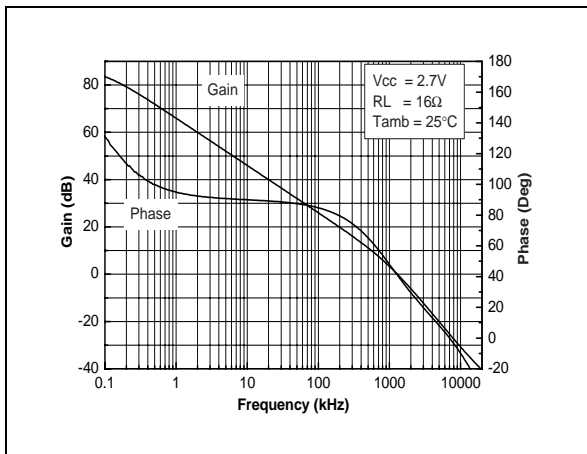

Open Loop Gain and Phase vs Frequency

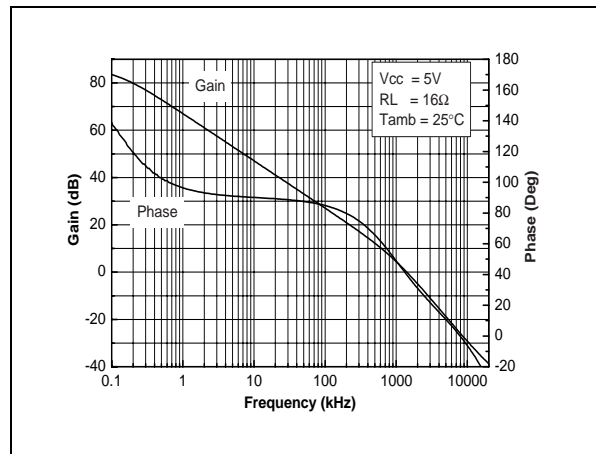

Open Loop Gain and Phase vs Frequency

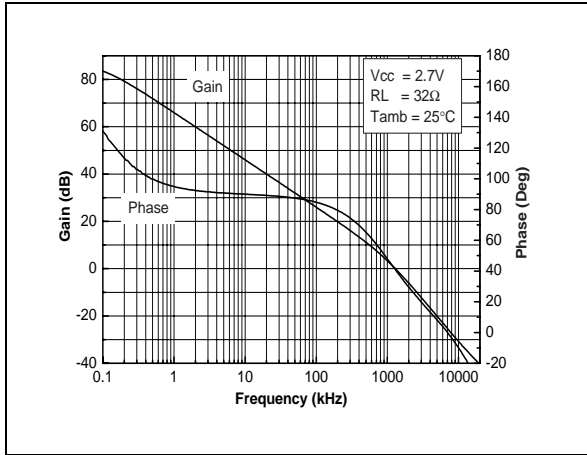

Open Loop Gain and Phase vs Frequency

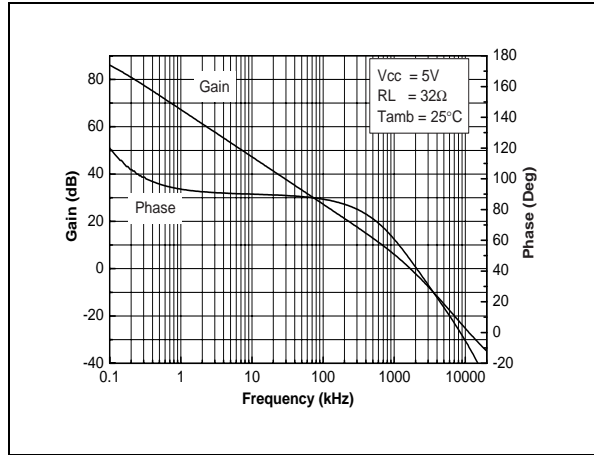

Open Loop Gain and Phase vs Frequency

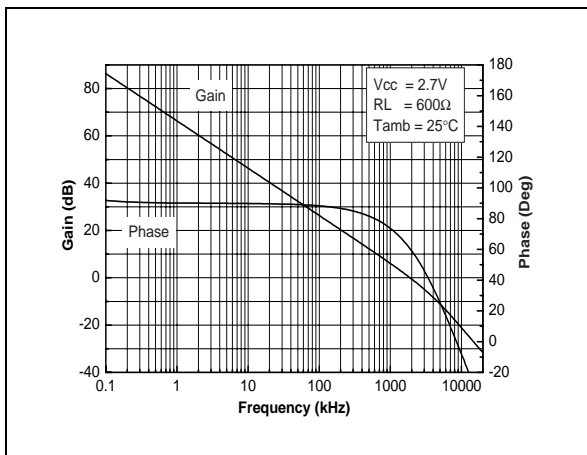

Open Loop Gain and Phase vs Frequency

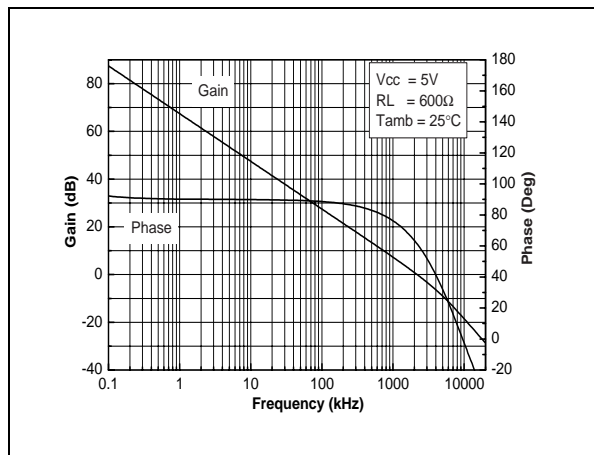

Open Loop Gain and Phase vs Frequency

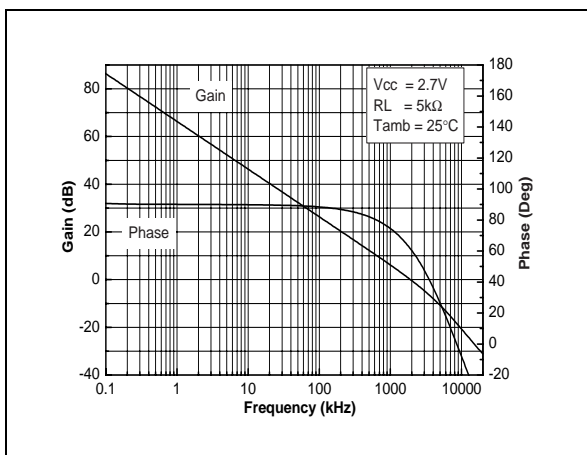

Open Loop Gain and Phase vs Frequency

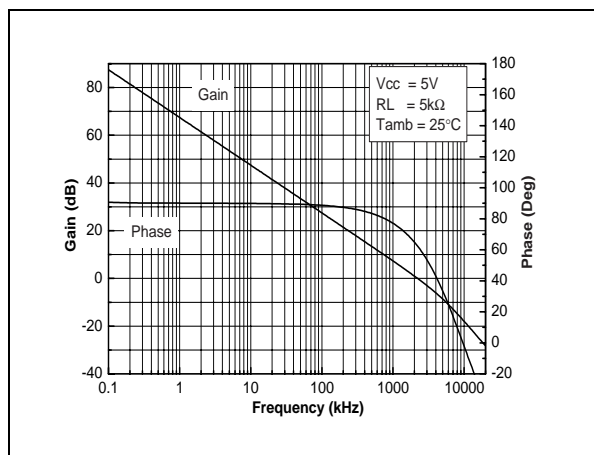

Phase Margin vs Supply Voltage

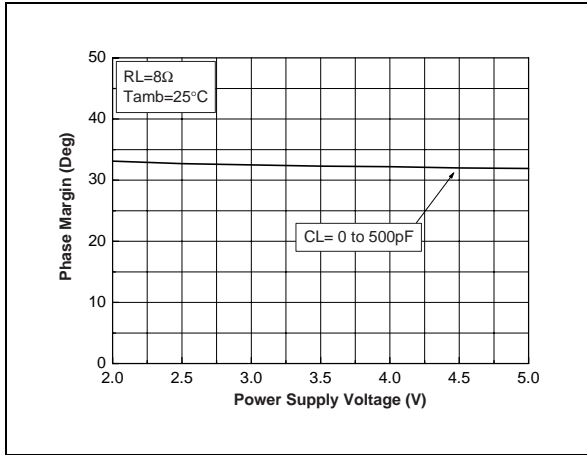

Gain Margin vs Supply Voltage

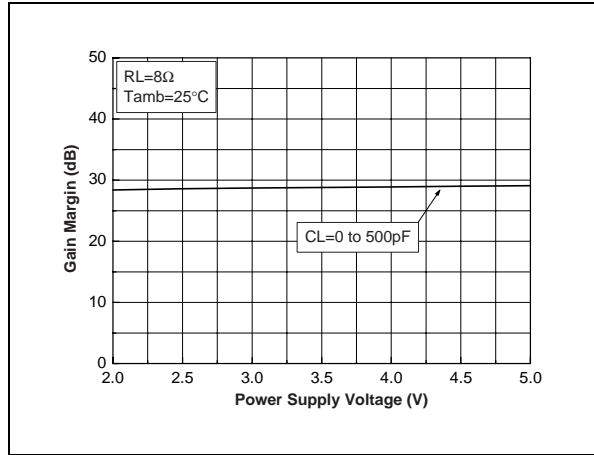

Phase Margin vs Power Supply Voltage

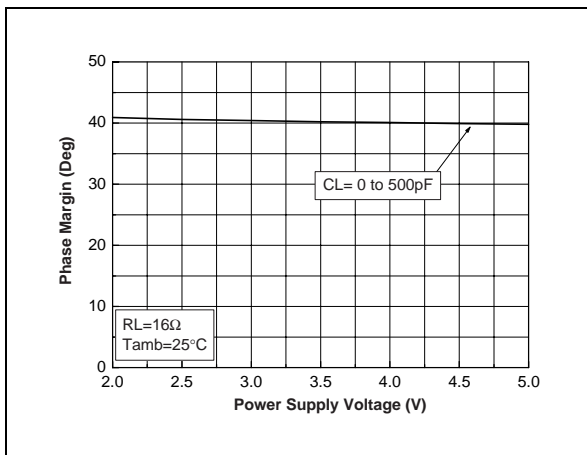

Gain Margin vs Power Supply Voltage

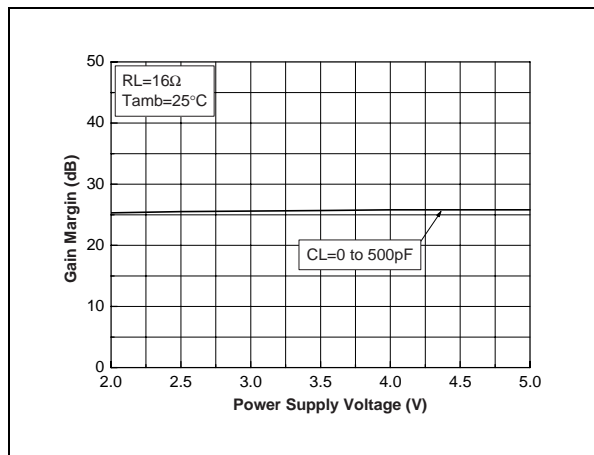

Phase Margin vs Power Supply Voltage

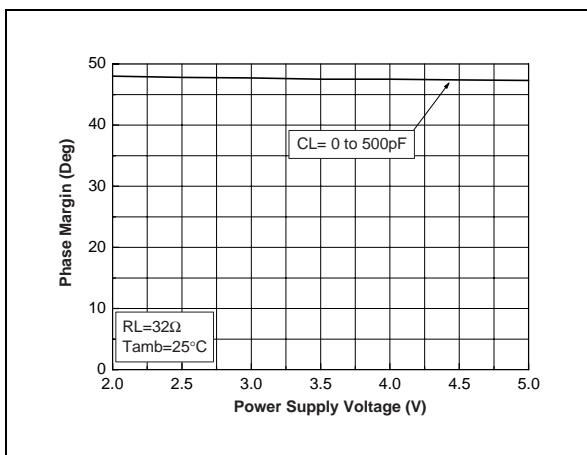

Gain Margin vs Power Supply Voltage

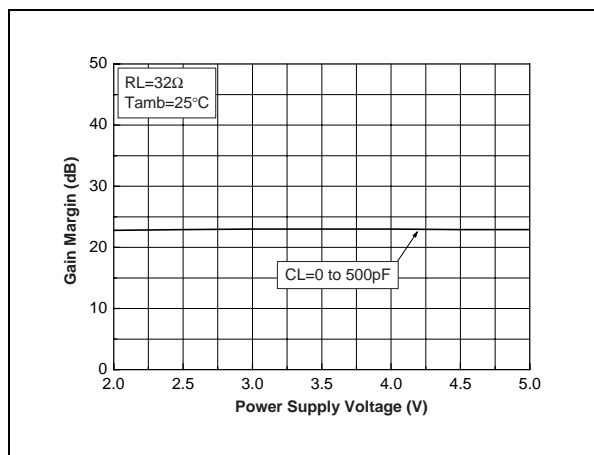

Phase Margin vs Power Supply Voltage

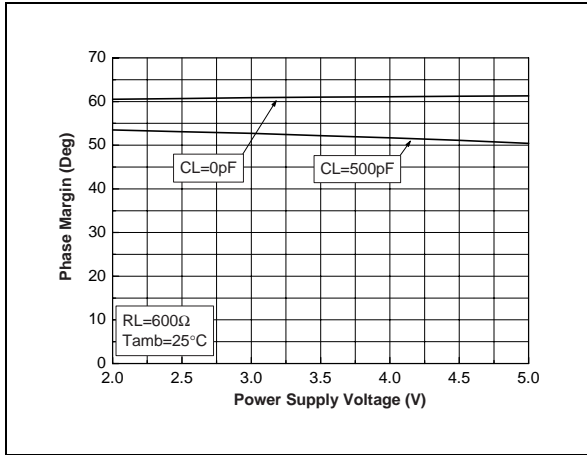

Gain Margin vs Power Supply Voltage

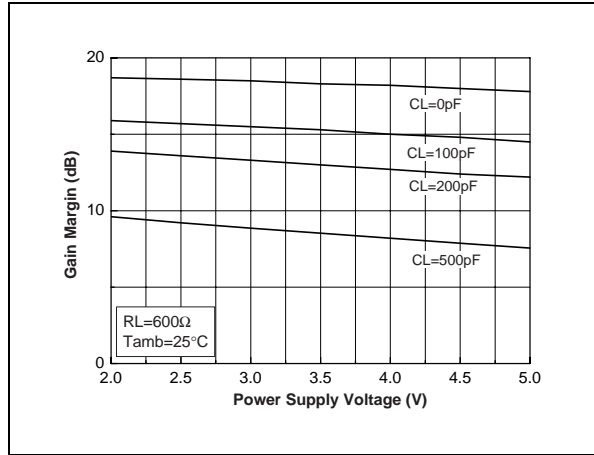

Phase Margin vs Power Supply Voltage

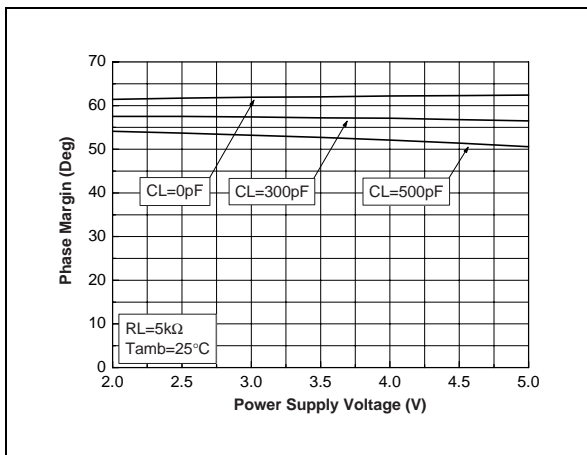

Gain Margin vs Power Supply Voltage

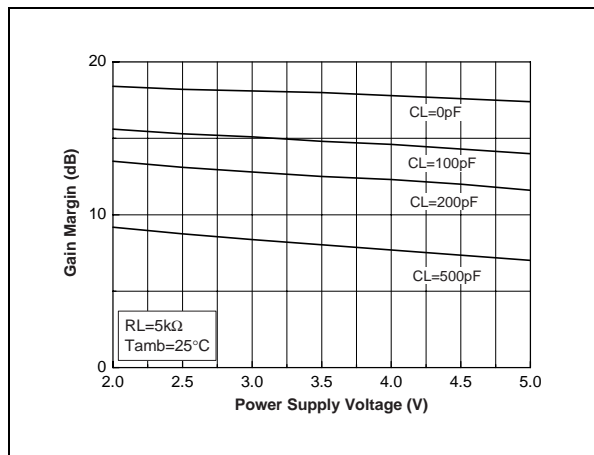

Distortion vs Output Voltage

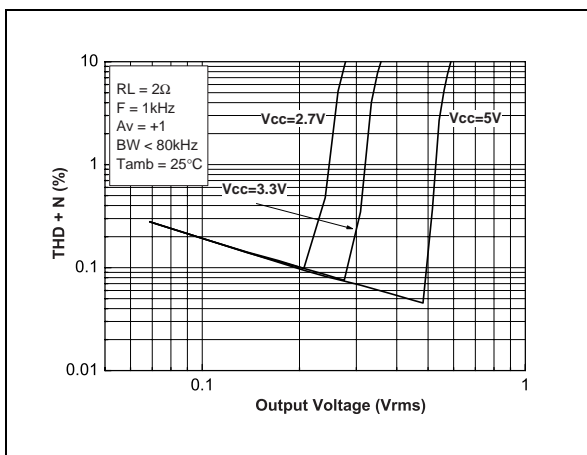

Distortion vs Output Voltage

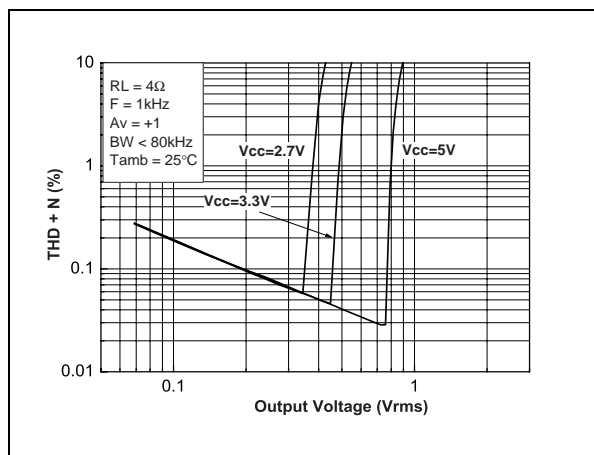

Distortion vs Output Voltage

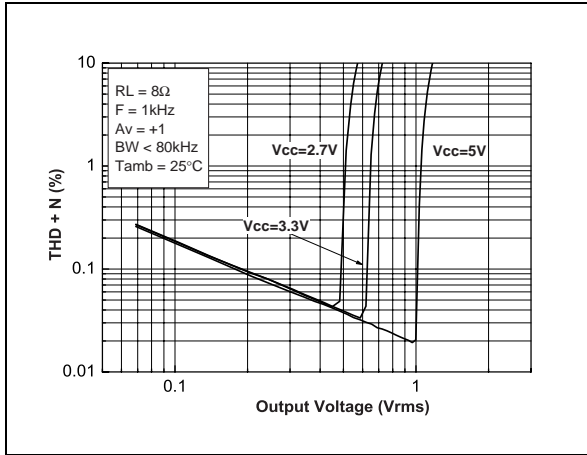

Distortion vs Output Voltage

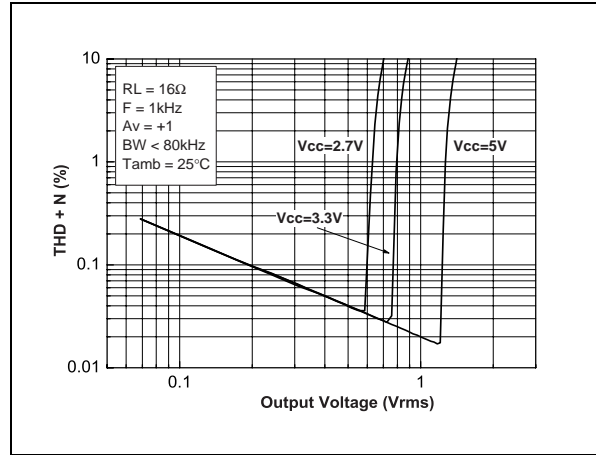

Crosstalk vs Frequency

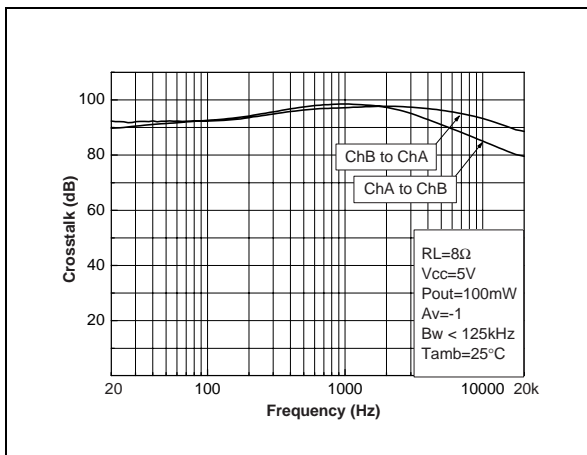

Crosstalk vs Frequency

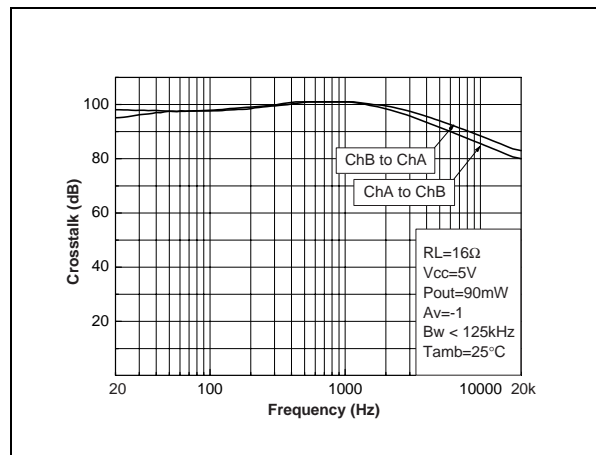

Crosstalk vs Frequency

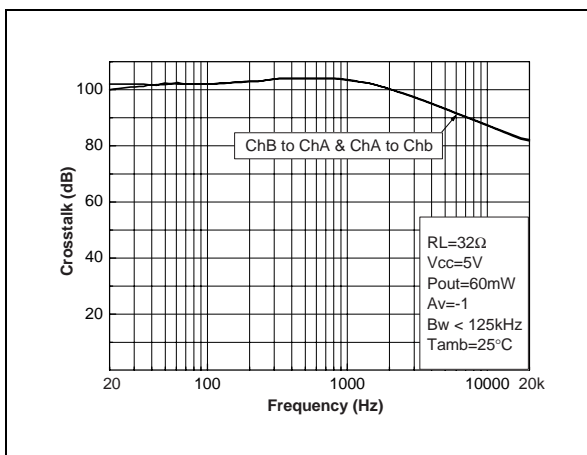

Crosstalk vs Frequency

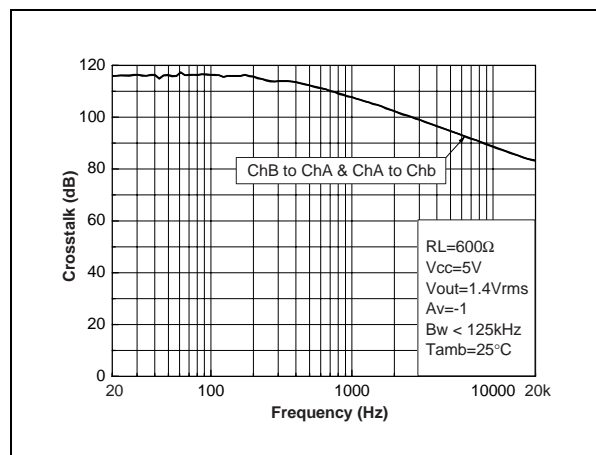

Crosstalk vs Frequency

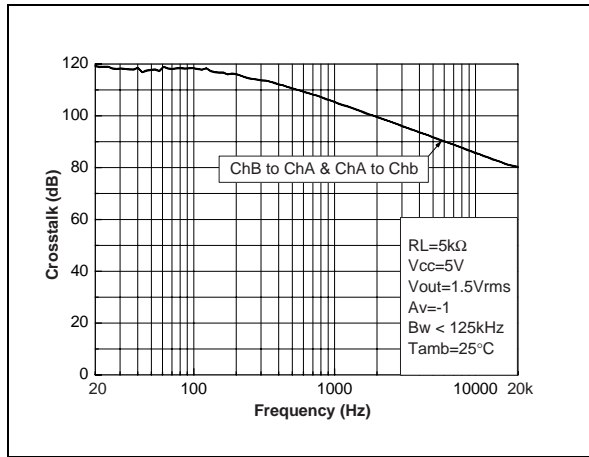

Equivalent Input Noise Voltage vs Frequency

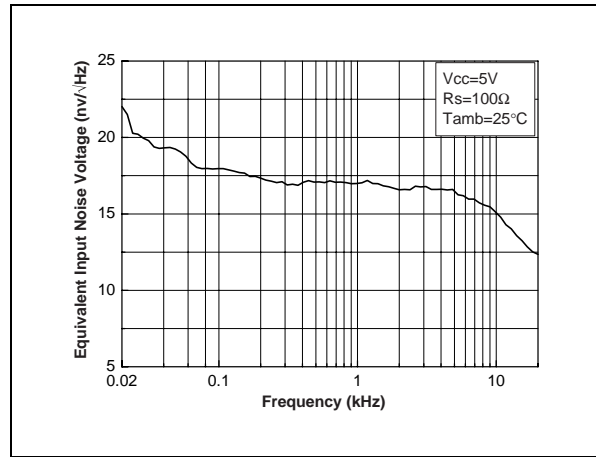

Power Supply Rejection Ratio vs Frequency

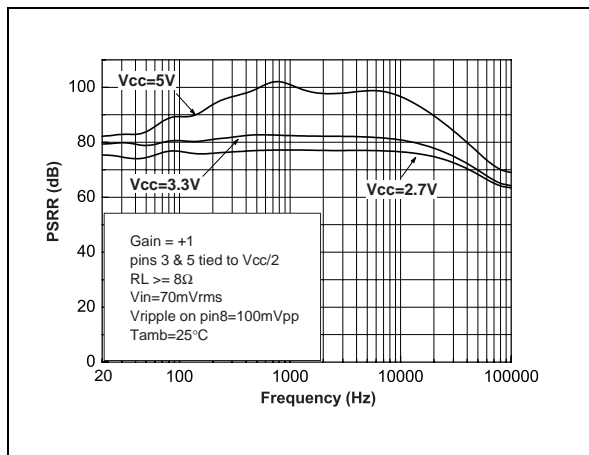

APPLICATION INFORMATION

Exposed Pad Package Description

The dual operational amplifier TS982 is housed in an SO8 Exposed-Pad plastic package. As shown in the figure below, the die is mounted and glued on a leadframe. This leadframe is exposed as a thermal pad on the underside of the package. The thermal contact is direct with the die and therefore, offers an excellent thermal performance in comparison with usual SO packages. The thermal contact between the die and the Exposed Pad is characterized using the parameter R_{thjc} .

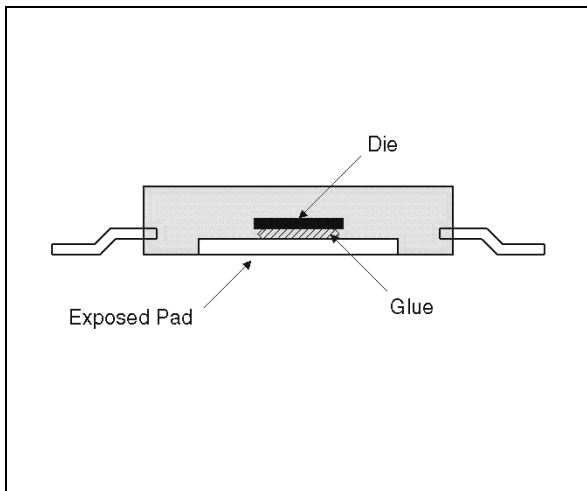

As 90% of the heat is removed through the pad, the thermal dissipation of the circuit is directly linked to the copper area soldered to the pad. In other words, the R_{thja} depends on the copper area and the number of layers of the printed circuit board under the pad.

TS982 Testboard layout: 6 cm² of copper topside:

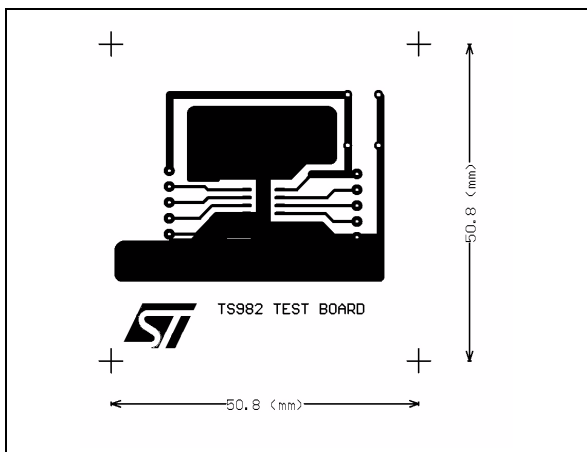

Exposed Pad Electrical Connection

In the SO8Epad package, the silicon die is mounted on the thermal pad (see the figure above). The silicon substrate is not directly connected to the pad because of the glue. Therefore, the copper area of the Exposed Pad must be connected to the substrate voltage (V_{cc-}) pin4.

Thermal Management Benefits

A good thermal design is important to maintain the temperature of the silicon junction below $T_j=150^{\circ}\text{C}$ as given in the Absolute Maximum Ratings and also to maintain the operating power level.

Another effect of temperature is that the life expectancy of an integrated circuit decreases exponentially at extended high temperature operation. Using one rule-of-thumb, the chip failure rates double for every 10 to 20°C. This demonstrates that reducing the junction temperature is also important to improve the reliability of the amplifier.

Thanks to the high dissipation capability of the SO8 Epad package, the dual OpAmpTS982 allows lower junction temperature at high current applications in high ambient temperatures.

Thermal Management Guideline

The following guidelines are a simple procedure to determine the PCB you should use in order to get the best from the SO8 Exposed Pad package:

- The first step is to determine the total power P_{total} to be dissipated by the IC.

$$P_{total} = I_{cc} \times V_{cc} + P_{amp1} + \dots + P_{amp2} \times I_{out1} + V_{drop2} \times I_{out2}$$

$I_{cc} \times V_{cc}$ is the DC power needed by the TS982 for operating with no load. You could refer to the curve 'Current Consumption vs Supply Voltage' to determine I_{cc} versus V_{cc} and versus temperature.

P_{amp1} is the power dissipated by the 1st operational amplifier to output a signal. If the output signal can be assimilated to a DC signal, you could simply calculate the dissipated power using the Voltage drop curves versus output current, supply voltage, temperature.

TS982

P_{amp2} is the power dissipated by the second operational amplifier.

- ❑ Specify the maximum operating temperature, (T_a) of the TS982.
- ❑ Specify the maximum junction temperature (T_j) at the maximum output power. As discussed above, T_j must be below 150°C and as low as possible for reliability considerations.
- ❑ The maximum thermal resistance between junction and ambient R_{thja} is then:

$$R_{thja} = (T_j - T_a) / P_{total}$$

Different PCBs can give the right R_{thja} for one application. The following curve gives the R_{thja} of the SO8Epad versus the copper area of a top side PCB.

R_{thja} of the TS982 vs Top Side Copper Area

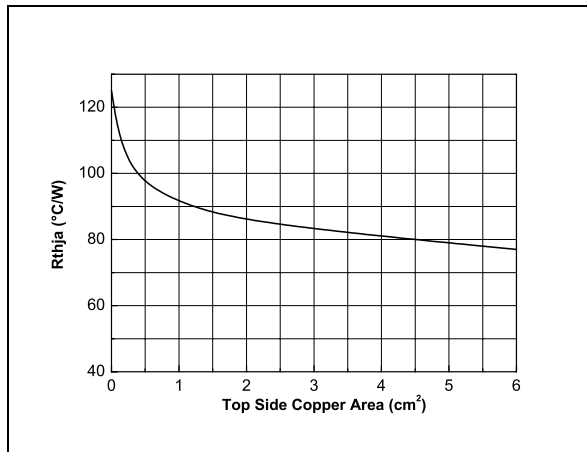

The ultimate R_{thja} of the package on a 4 layers PCB under natural convection conditions, is $45^\circ\text{C}/\text{W}$ by using two power planes and metallized holes.

Parallel Operation

Using the two amplifiers of the TS982 in parallel mode allows higher output current: 400 mA.

Parallel Operation: 400mA Output Current

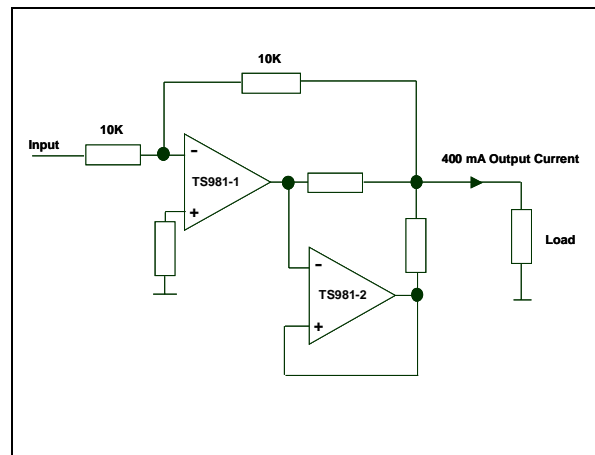

PACKAGE MECHANICAL DATA

8 PINS - PLASTIC MICROPACKAGE (SO Exposed-Pad)

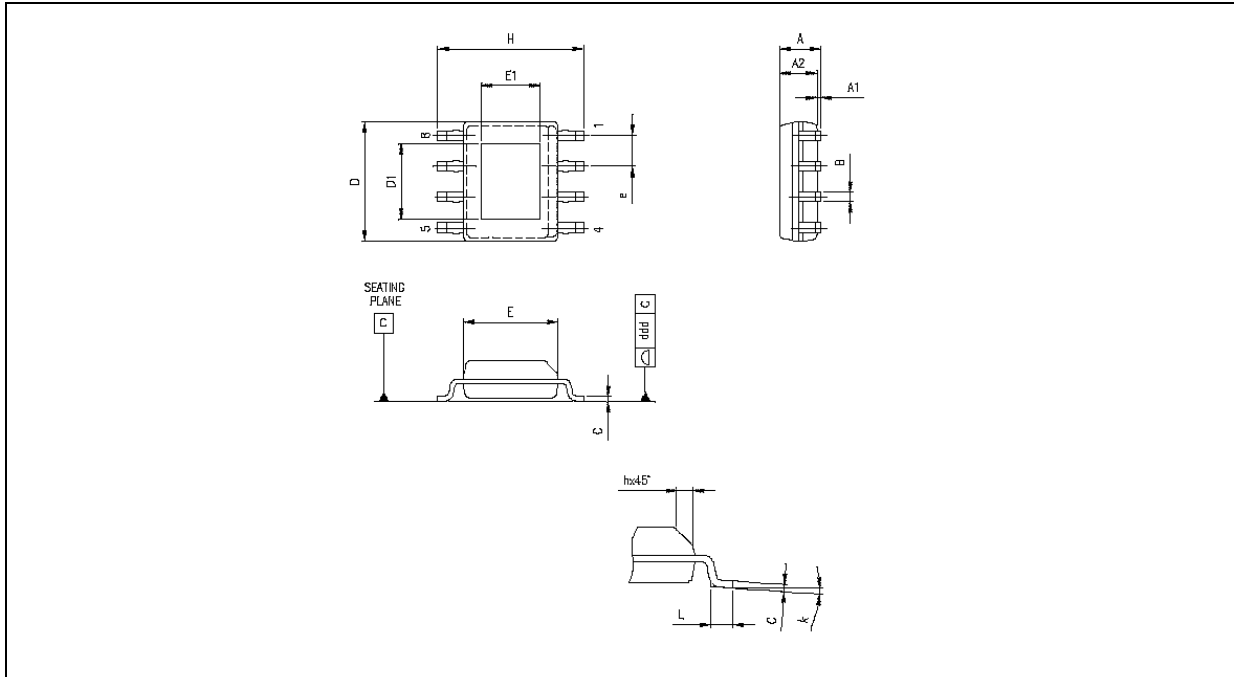

Dim.	Millimeters			Inches		
	Min.	Typ.	Max.	Min.	Typ.	Max.
A	1.350		1.750	0.053		0.069
A1	0.000		0.250	0.001		0.010
A2	1.100		1.650	0.043		0.065
B	0.330		0.510	0.013		0.020
C	0.190		0.250	0.007		0.010
D	4.800		5.000	0.189		0.197
D1		3.10			0.122	
E	3.800		4.000	0.150		0.157
E1		2.41			0.095	
e	1.270			0.050		
H	5.800		6.200	0.228		0.244
h	0.250		0.500	0.010		0.020
L	0.400		1.270	0.016		0.050
k	0d		8d	0d		8d
ddd			0.100			0.004

Information furnished is believed to be accurate and reliable. However, STMicroelectronics assumes no responsibility for the consequences of use of such information nor for any infringement of patents or other rights of third parties which may result from its use. No license is granted by implication or otherwise under any patent or patent rights of STMicroelectronics. Specifications mentioned in this publication are subject to change without notice. This publication supersedes and replaces all information previously supplied. STMicroelectronics products are not authorized for use as critical components in life support devices or systems without express written approval of STMicroelectronics.

© The ST logo is a registered trademark of STMicroelectronics

2003 STMicroelectronics - All Rights Reserved
STMicroelectronics GROUP OF COMPANIES

Australia - Brazil - Canada - China - Finland - France - Germany - Hong Kong - India - Israel - Italy - Japan - Malaysia
 Malta - Morocco - Singapore - Spain - Sweden - Switzerland - United Kingdom - United States

<http://www.st.com>

